



Top



Bottom

SWLP.2450.12.4.B.02

## Specification

<b>Part No.</b>	SWLP.2450.12.4.B.02
<b>Product Name</b>	12mm*12mm*4mm 2.4GHz SMD Patch Antenna
<b>Feature</b>	For Wi-Fi/WLAN/ISM/Zigbee Industrial Applications ROHS Compliant High Gain 2dBi

## 1. Introduction

This 12mm\*12mm\*4mm high gain 2.4GHz patch antenna is ideally suited for high performance industrial applications in Wi-fi, ISM, Zigbee bands.

This product has highest gain in the XZ (azimuth) plane direction, most suitable for fixed wireless applications where transmission and reception is focused to one hemisphere of the device, for example a wireless meter on a reinforced concrete wall.

It can also be placed anywhere on the device ground-plane, unlike most chip or loop antennas which need to be edge mounted.

## 2. Key Antenna Performance Indicators\*

No.	Parameter	Specification
1	Range of Receiving Frequency	2400 MHz to 2500 MHz
2	Bandwidth	100 MHz @ -7dB
3	Polarization	Linear
	VSWR	3.0 max @ Center Frequency
	Peak Gain	+2 dBi typ.
	Impedance	50 Ohms
4	Dimensions	12mm x 12mm x 4mm
5	Operating Temperature	-40°C to +85°C
6	Storage Temperature	-40°C to +85°C
	Termination	Ag (Environmentally Friendly Pb Free)

Original Patch Specification measured on EVB 50\*50mm, actual value depends on ground-plane and housing

### 3. Mechanical Specifications

#### 3.1 Return Loss



With 50×50mm<sup>2</sup> Evaluation board

### 3.2 Definition of X-Y-Z Plane

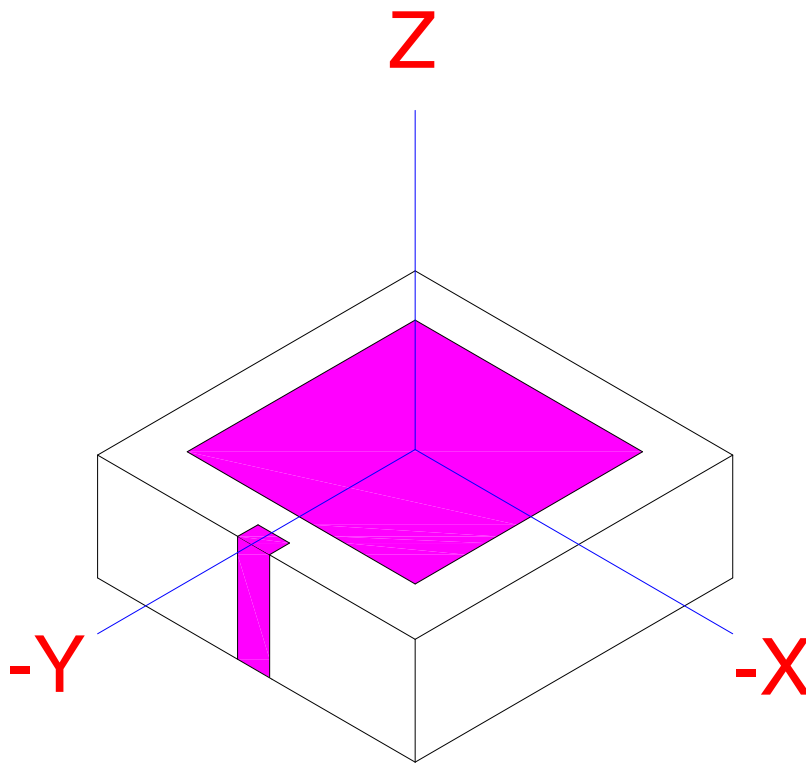

### 3.3 Radiation Patterns

#### XY Plane

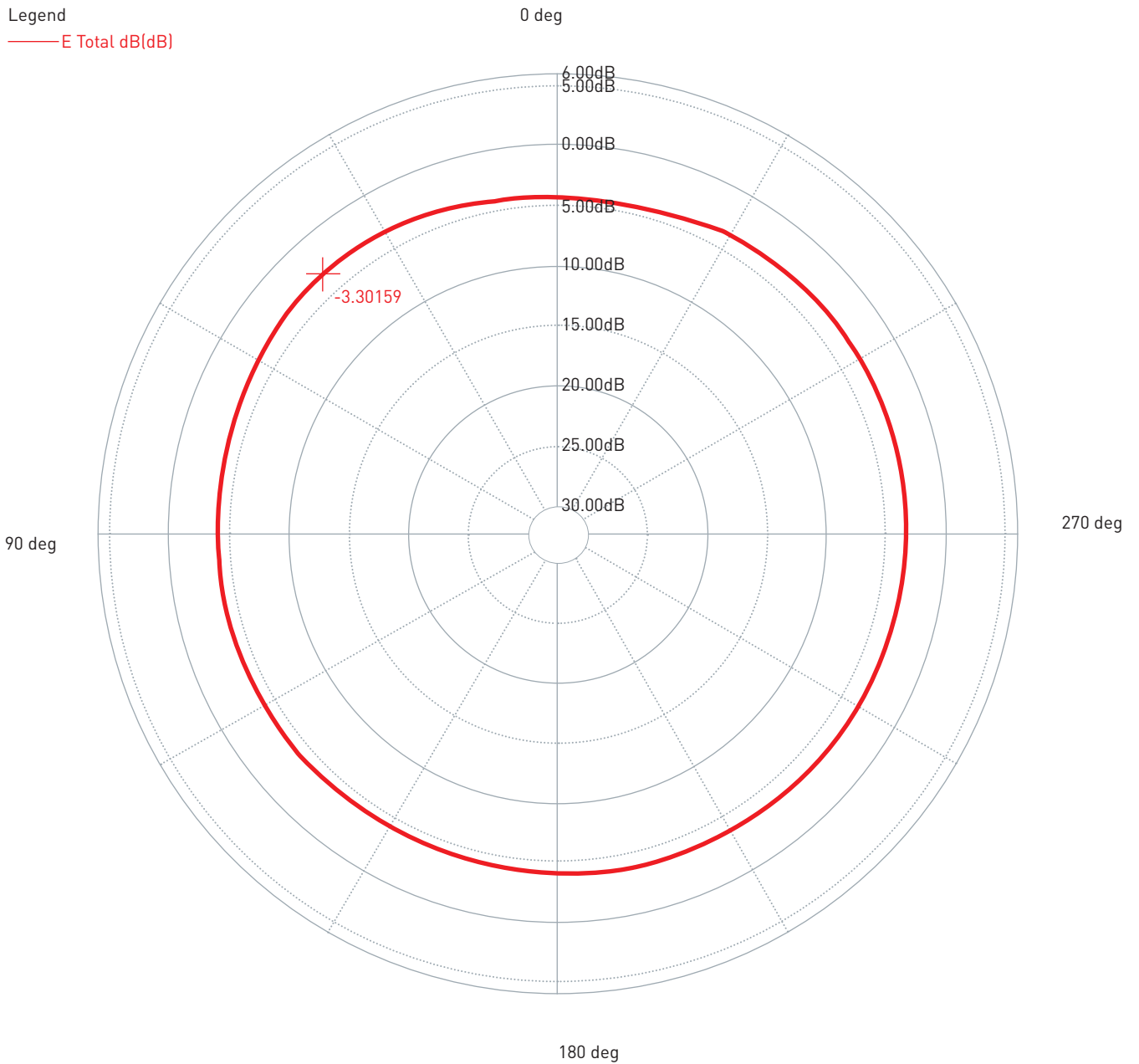

### 3.3 Radiation Patterns

#### XZ Plane

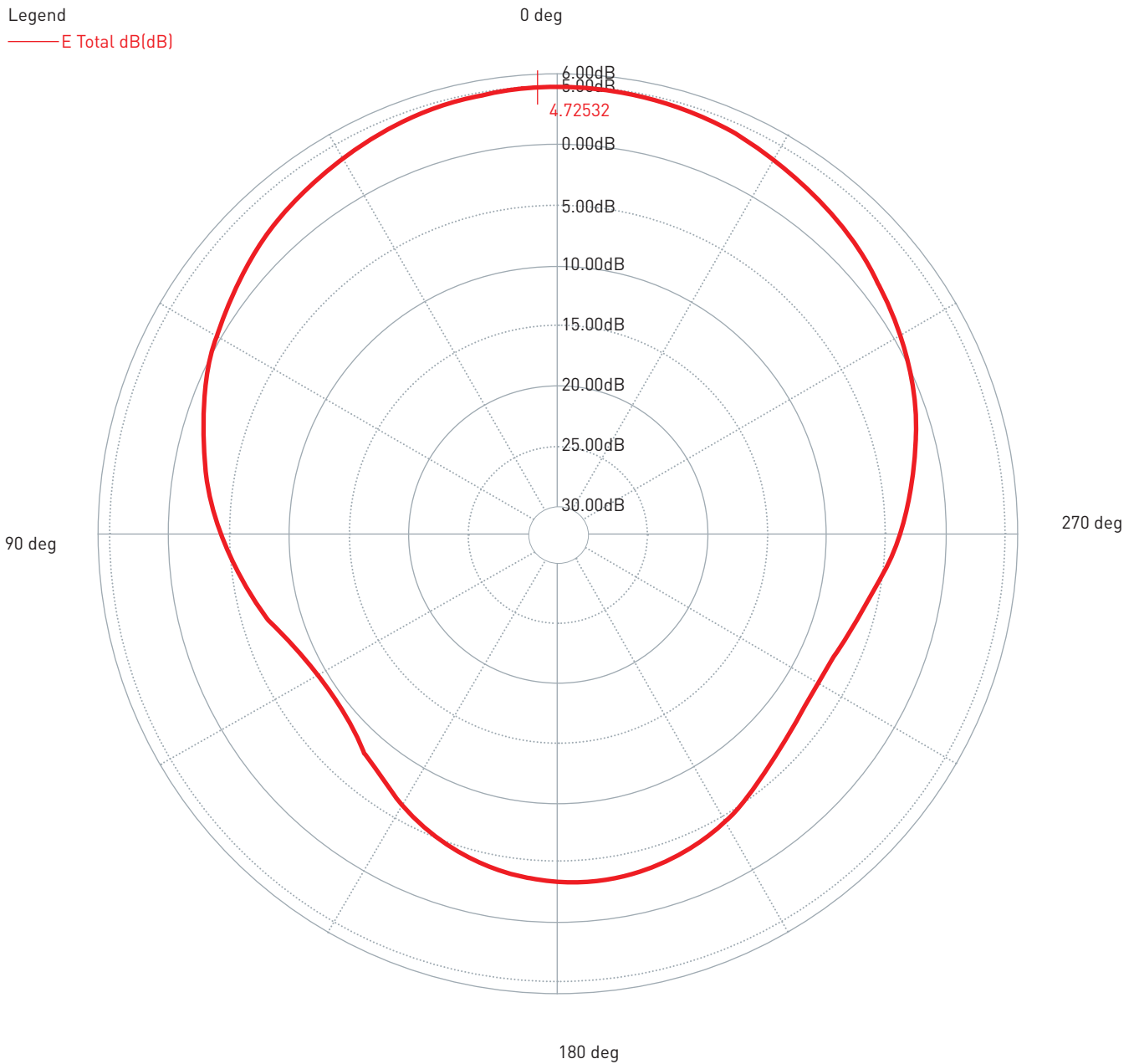

### 3.3 Radiation Patterns

#### YZ Plane

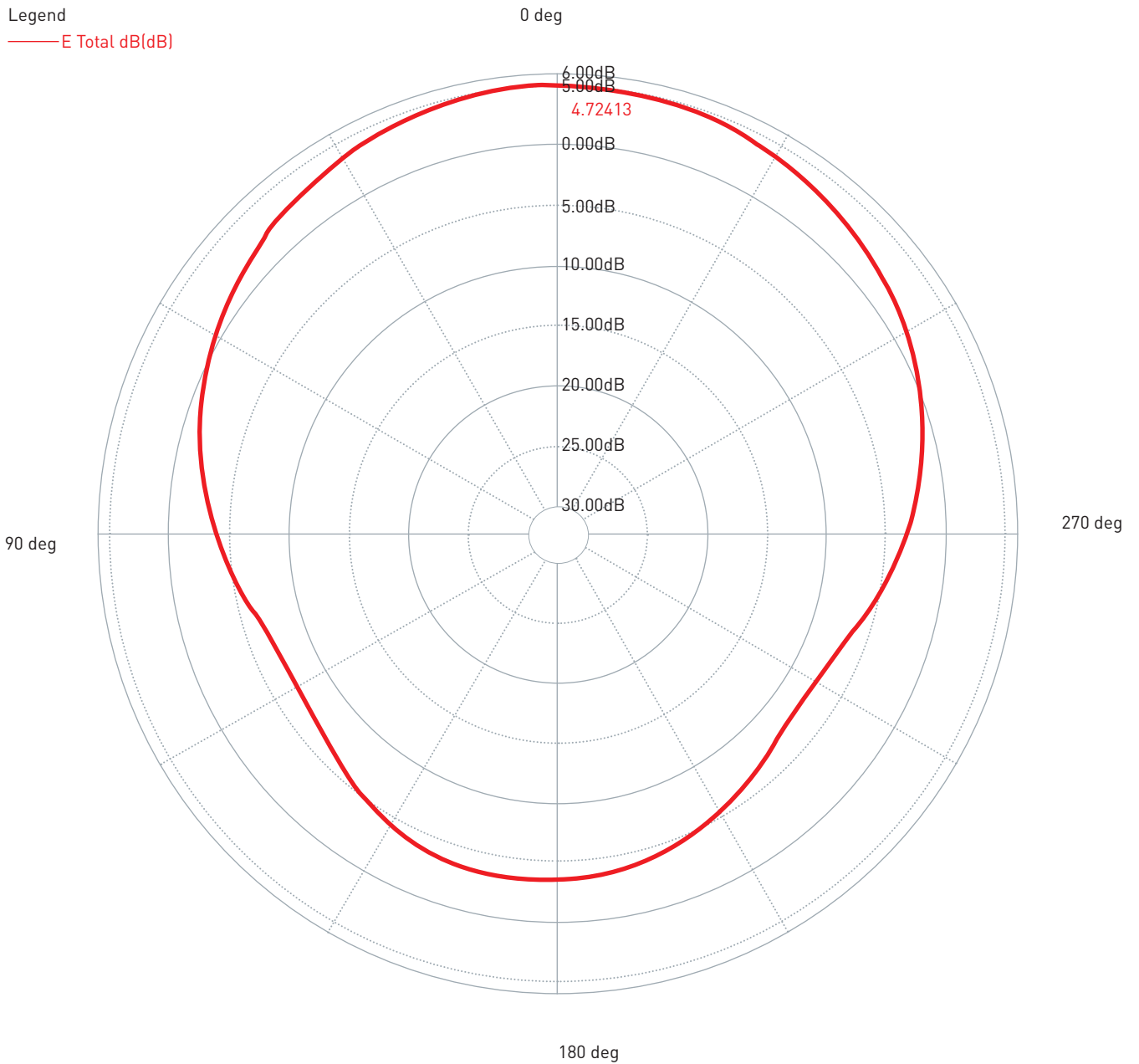

### 3.4 Efficiency Chart

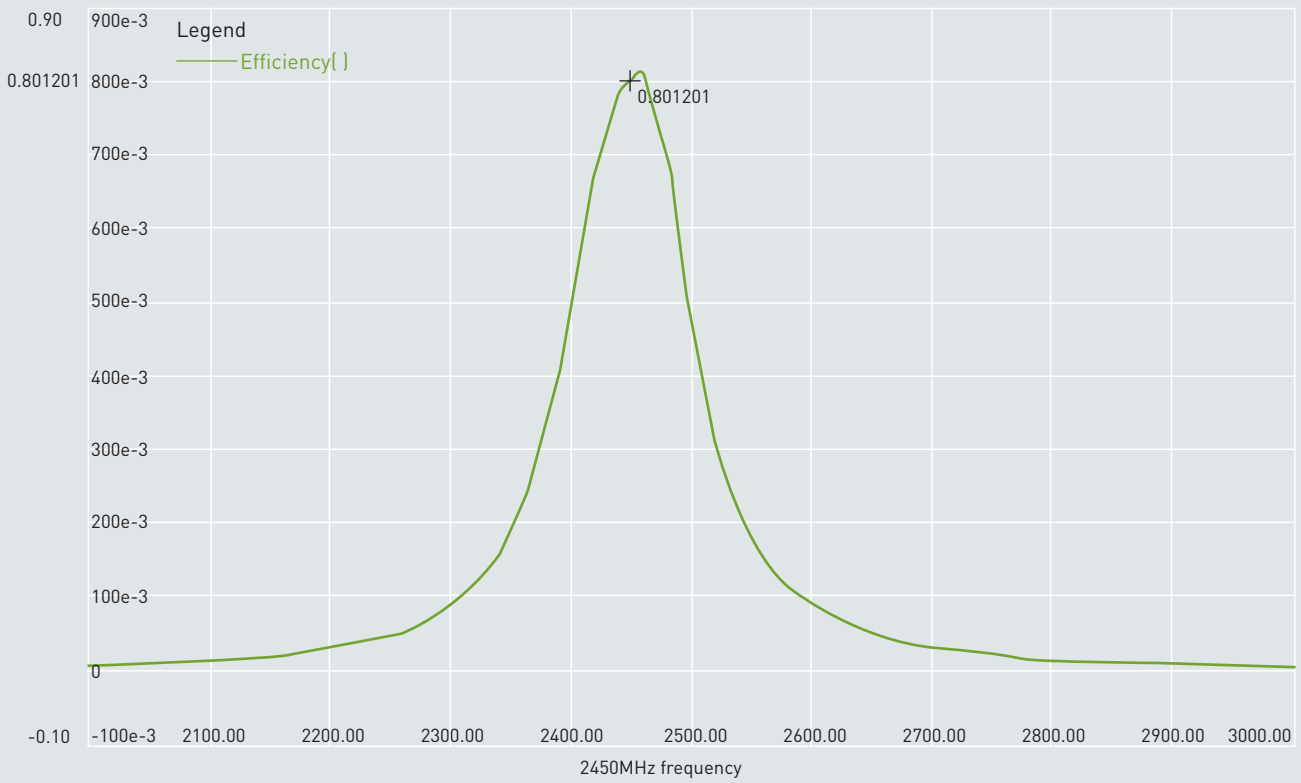





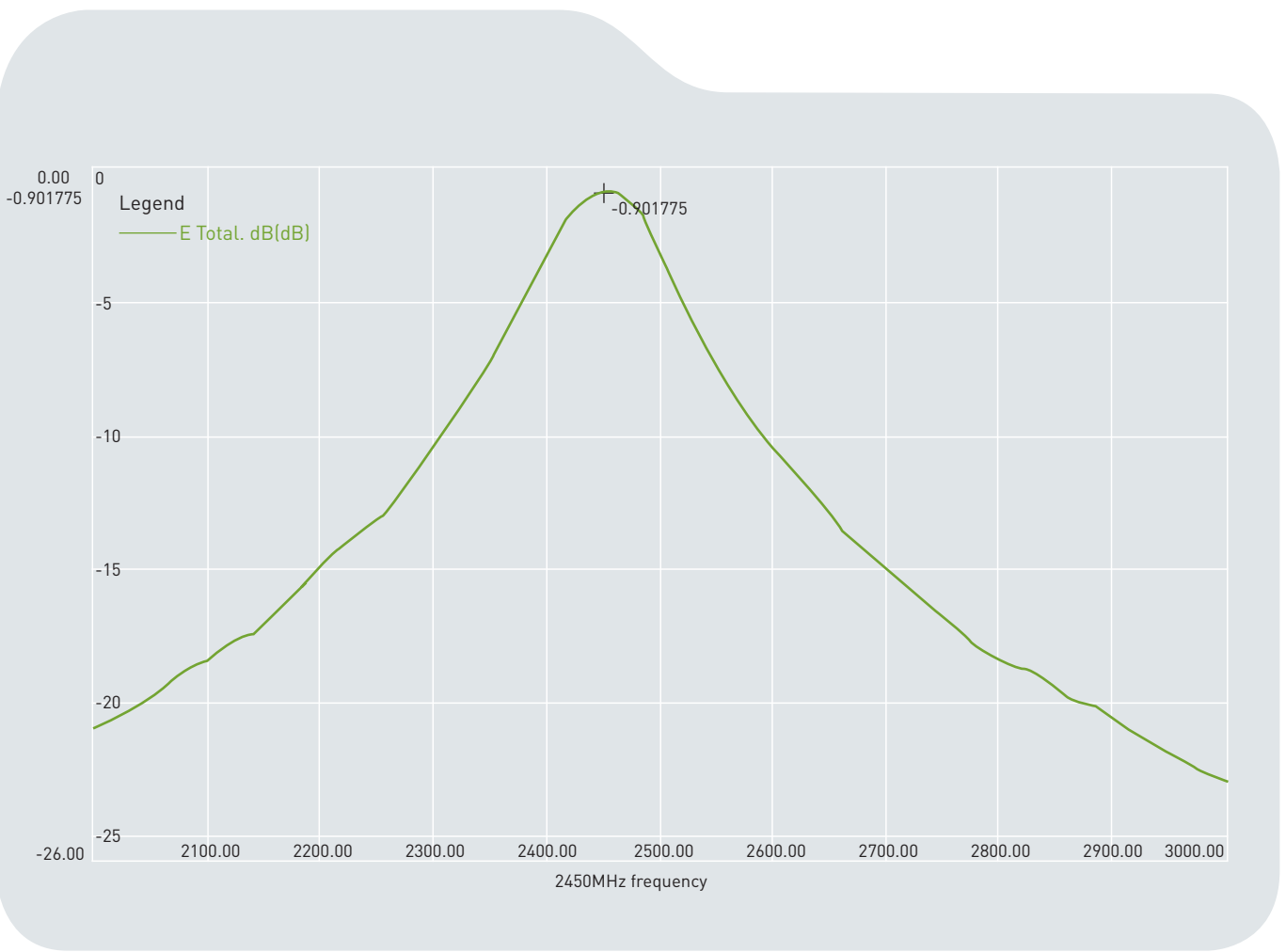

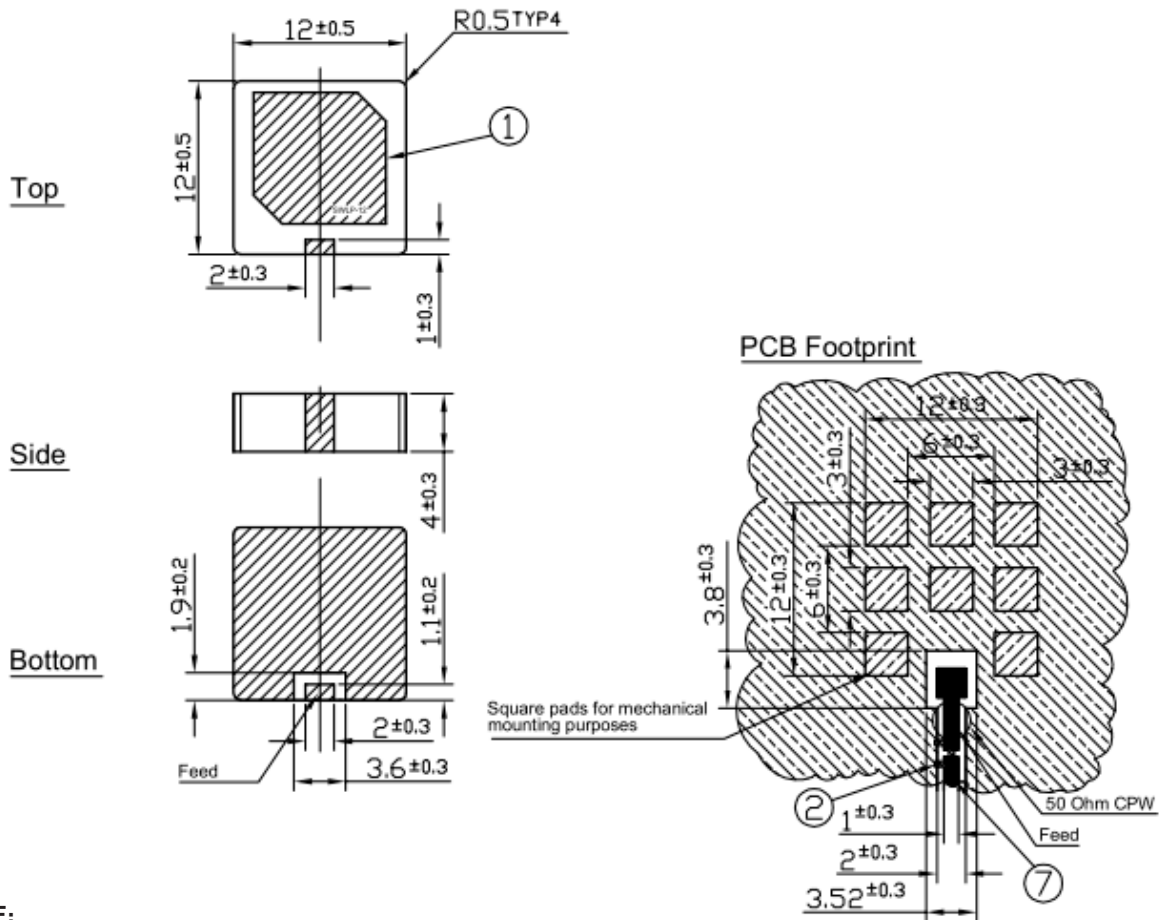

### 3.5 Average Gain



## 4. Shape and Dimensions



### NOTE:

1. Silver area 
2. Solder mask 
3. Area to be soldered 
4. Feed area 
5. Clearance area 
6. Match Component (Capacitor) 
7. Unique dimensioning according to your PCB inductor and capacitor values according to your specific device
8. Dimensions of 50 Ohm CPW dependent on individual board
9. Matching circuit capacitor and inductor values dependent on individual environment

Name	Material	Finish	QTY
1 SWLP.12 Patch 12x12x4	Ceramic	Clear	1
2 Match Component (Capacitor)	Ceramic	White	3

# Evaluation Board Dimension

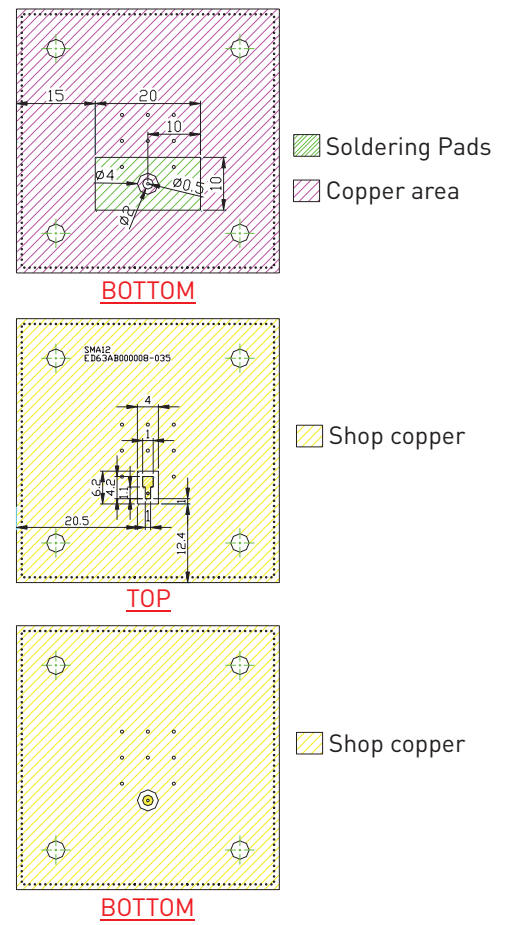
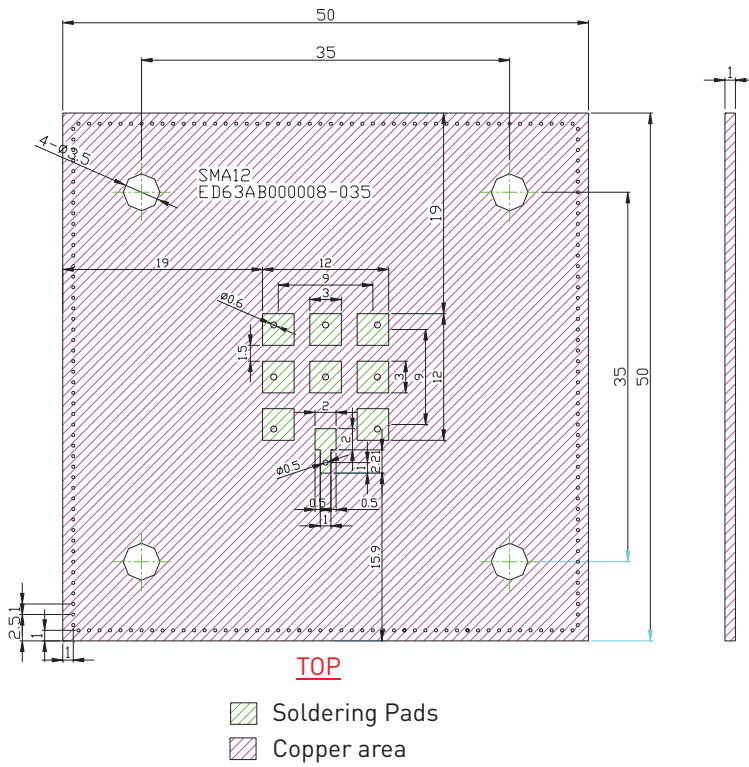

## 5. Packaging

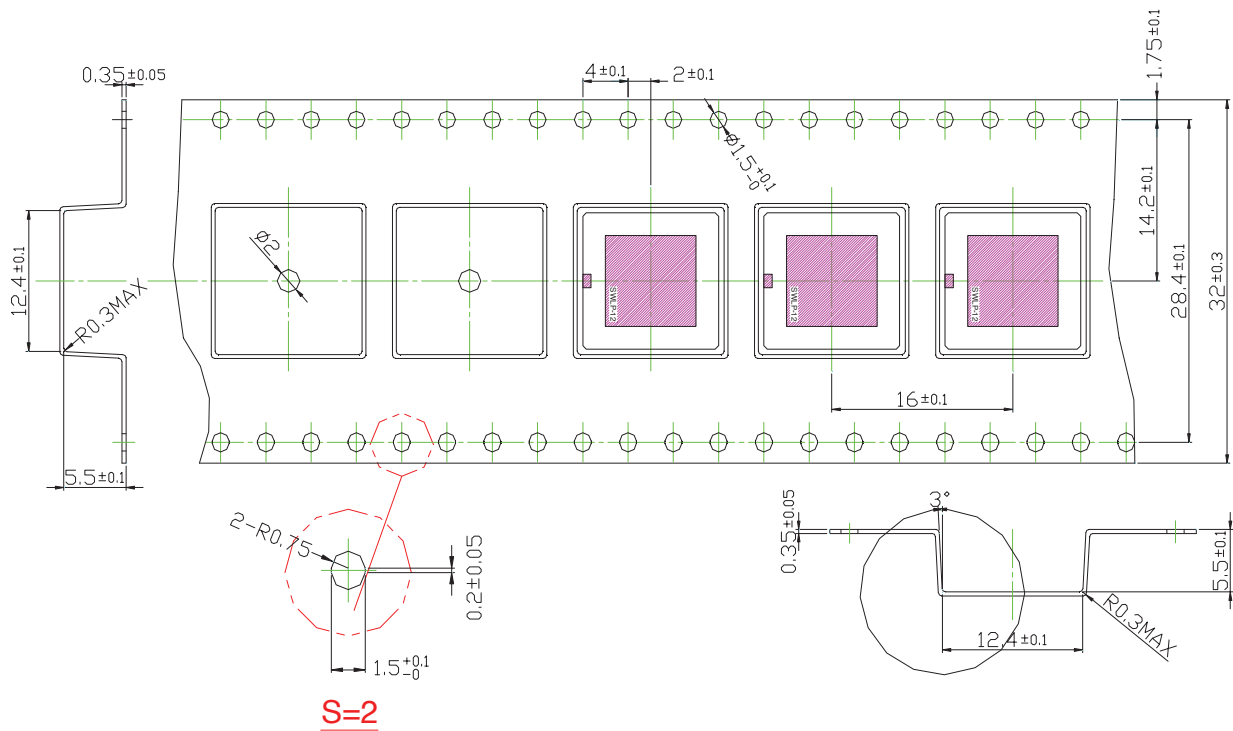
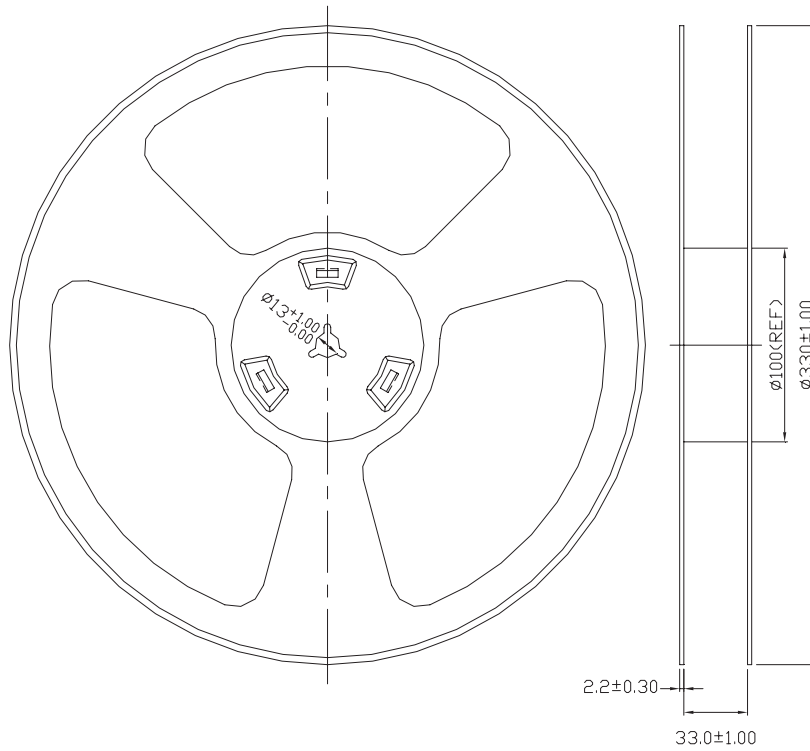

## 6. Recommended Reflow Temperature Profile

### 6.1 Flux, Solder

- Use rosin-based flux. Don't use highly acidic flux with halide content exceeding 0.2wt%(chlorine conversion value).
- Use Sn solder.

### 6.2 Reflow soldering conditions

- Pre-heating should be in such a way that the temperature difference between solder and product surface is limited to 150°C max. Cooling into solvent after soldering also should be in such a way that temperature difference is limited to 100°C max. Unwrought pre-heating may cause cracks on the product, resulting in the deterioration of products quality.

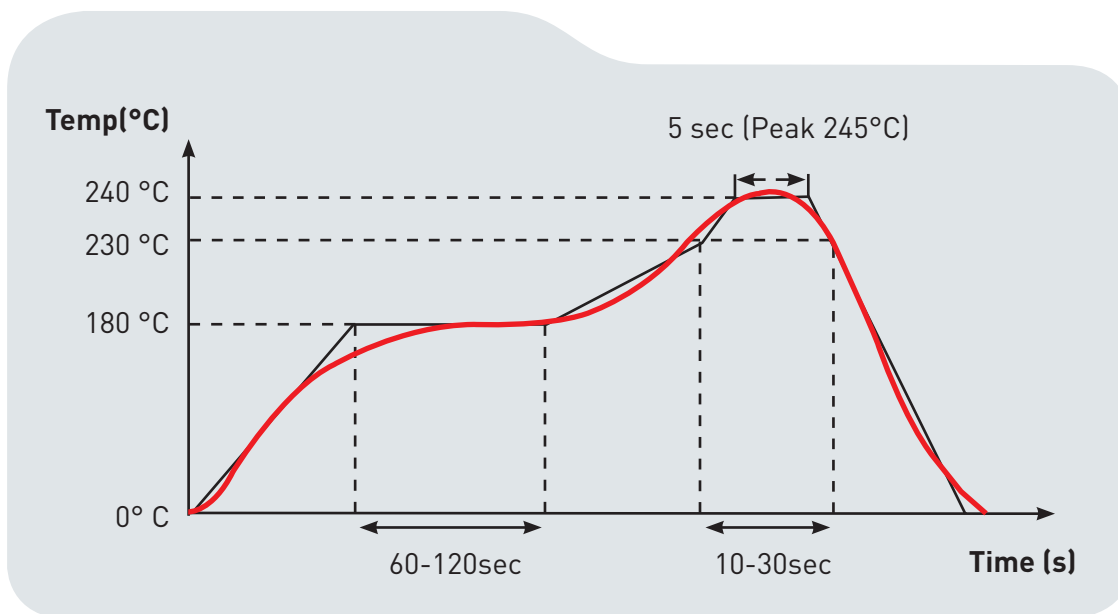

### 6.3 Reworking with soldering iron

- The following conditions must be strictly followed when using a soldering iron

Pre-heating	150°, 1 min
Tip temperature	290° max
Soldering iron output	30w max
Soldering time	3 second max