



life.augmented

Products and solutions for Wearable devices





Content

Introduction	3
Motion, Environmental and Proximity sensors	4
Signal conditioning	9
Microcontrollers	11
Security	18
Connectivity	21
Power management	28
User interface	34
Serial EEPROM	36
ESD protection	37
EMI filtering	38
Design support	39





Introduction

STMicroelectronics offers smart solutions for wearable devices

Leveraging its long experience in a wide range of technologies, ST offers a selection of products specifically designed for wearable devices targeting applications such as:

- Consumer fitness and wellness
- Healthcare
- Portable infotainment
- Worker safety

In these applications high precision, low power consumption, compact form factor and outstanding performance are a must and ST's products take into account the needs of the most recent and innovative wearable devices.

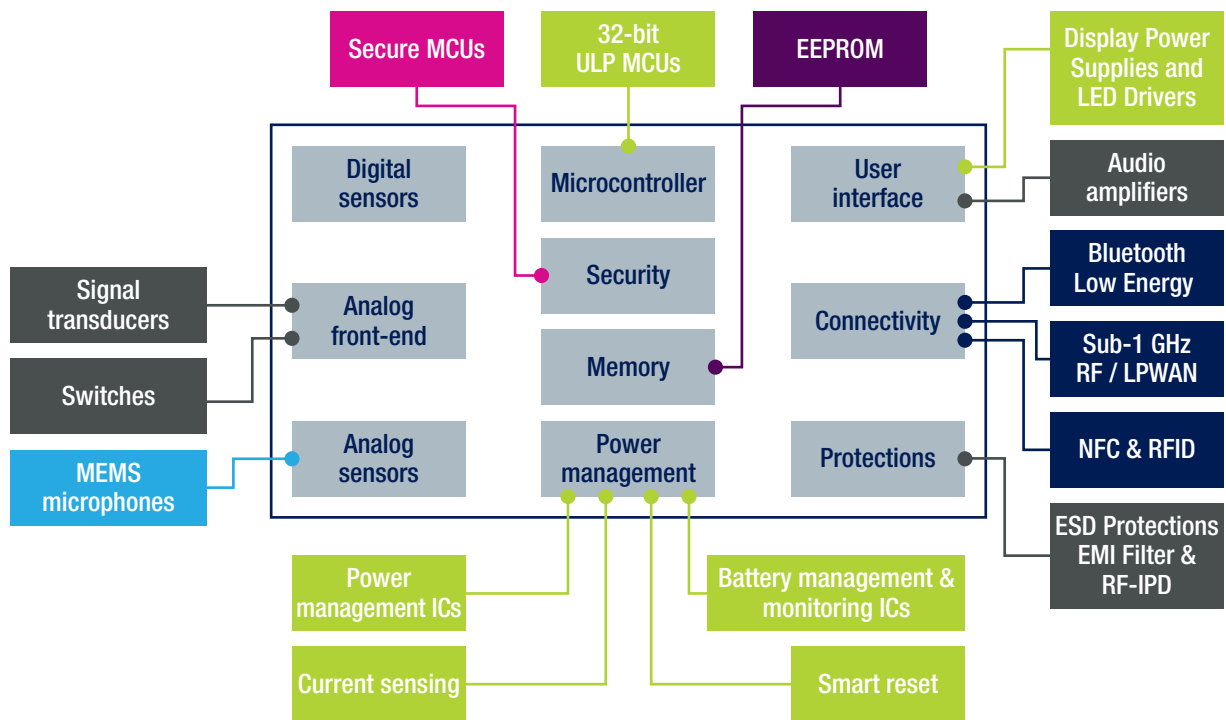



MEMS and Sensors



The most diversified and complete MEMS and sensors supplier

ST has shipped more than 13 billion micro-electromechanical sensors and has one of the industry's most extensive sensor portfolio including proximity and MEMS accelerometers, gyroscopes, digital compasses, inertial modules, microphones, and environmental sensors such as pressure, temperature and humidity sensors.

4

- A unique sensor portfolio, from discrete to fully-integrated solutions, to meet all design needs
- High-volume manufacturing capacity to provide cost competitive solutions, fast time-to-market and security of supply
- High-performance sensor fusion to improve the accuracy of multi-axis sensor systems in order to enable emerging and highly-demanding applications, such as indoor navigation and location-based services
- High-quality products, already tested in different application fields, including mobile, portable, gaming, consumer, automotive and health care segments
- Multiple sites dedicated to MEMS, with full in-house dual-sourcing, guaranteeing 100% security of supply

COMPLETE SOLUTION

- Large sensor portfolio
- Integrated hardware and software solutions
- 100% security of supply
- Scalability of solutions
- Quality is a must for ST
- ST is MEMS market leader

SENSORS FOR IMPROVING WEARABLE APPLICATIONS

- Athlete performance monitoring
 - Movement recognition through shoes and wearable sensors (AXL, GYRO, PS)
 - Sport equipment swing detection swing detection (AXL, GYRO, MAG)
 - Body tracking recognition (AXL, GYRO, MAG, PS)
- Watches, personal navigation devices, PND and pedometers (AXL, GYRO, MAG, PS)
 - Map orientation
 - Heading and navigation
 - Power-saving using auto-wake-up functionality
 - Taps display activation

ACCELEROMETERS

ST's state-of-the-art MEMS accelerometers include analog and digital sensors featuring up to $\pm 400g$ acceleration full scale and from 1.71 to 3.6 V supply voltage. Accelerometers have advanced power-saving features that make them suitable for ultra-low-power applications. These features include low-power mode, auto wake-up function and a FIFO buffer that can be used to store data, thus reducing the host processor loading and system power consumption. The small size and embedded features of ST's accelerometers make them an ideal choice for wearable applications and where long battery life is required.



KEY FEATURES

- Low power consumption and smart ultra-low-power operating modes including Always-on
- High resolution: accuracy and stability
- Selectable full-scale up to 16g
- Smart embedded features for less power hungry systems
- Ultra compact devices in packages smaller than 4 mm³
- Advanced digital features
- Pin to pin compatible product family

Part number	Package size (mm)	Full-scale typ (g)	Noise RMS (mg)	Key features
LIS2DS12	2 x 2 x 0.86	$\pm 2; \pm 4; \pm 8; \pm 16$	0.65**	14-bit, embedded temperature compensation, long FIFO, Smart features and pedometer
LIS2DH12	2 x 2 x 1	$\pm 2; \pm 4; \pm 8; \pm 16$	3	12-bit, ultra low power
LIS2DE12	2 x 2 x 1	$\pm 2; \pm 4; \pm 8; \pm 16$	9	8-bit, ultra low power
LIS2DW12	2 x 2 x 0.7	$\pm 2; \pm 4; \pm 8; \pm 16$	1.3	16 bit data output, Ultra-low power consumption: 50 nA in powerdown mode, below 1 μA in active low-power mode, Multiple operating modes with multiple bandwidth

Note: Only tape and reel versions available
 ** RMS noise @ 50Hz FS 2g, 14 bit setting



DIGITAL COMPASSES

ST's digital compasses include combo solutions, with an accelerometer and magnetic sensor integrated in a single LGA package and standalone magnetometer, to give the possibility of designing a solution locating the magnetic sensor in the best position on the board in order to minimize magnetic interference.



KEY FEATURES

- Ultra-compact high-performance magnetometer module
- Wide magnetic sensor dynamic range and ultra low magnetic offset
- Embedded Self Test and Temperature compensated
- Pin to pin compatible product family

Part number	Package	Range (g) typ	Magnetic Range (Gauss) typ	Current Consumption (mA) typ	Current Consumption (mA) (Power Down Mode) typ
LSM303AH	LGA-12 2 x 2 x 1	±2, ±4, ±8, ±16	30	0.162	2.5E-4

Note: Only tape and reel versions available

INEMO® INERTIAL MODULES

iNEMO System-in-packages (SiP) combine accelerometer, gyroscope and magnetometer in a monolithic 6-axis or 9-axis solution. The integration of multiple sensor outputs bring motion sensing systems to the level of accuracy required for the most demanding applications, such as enhanced gesture recognition, gaming, augmented reality, indoor navigation and localization-based services.



MAIN FEATURES

- Always-on 3D accelerometer and 3D gyroscope
- Android M compliant
- Pedometer, step detector and step counter
- Rate noise density 4mdps/√Hz (High Perf. Mode)
- Embedded Self Test and Temperature sensor

Part number	Package	Range (g) typ	Angular Rate Range typ	Angular Rate Noise Density (°/s/√Hz) typ
LSM6DSL	VFLGA 2.5 x 3 x .86 14L P. 5 L. 475 x .25	±2, ±4, ±8, ±16	2000	-
LSM6DSM	VFLGA 2.5 x 3 x .86 14L P. 5 L. 475 x .25	±2, ±4, ±8, ±16	2000	0.0038

PRESSURE SENSORS

ST's absolute digital output barometer integrates ST's consolidated pressure sensor with a new fully-molded package to further improve robustness, reliability and moisture resistance while reducing package thickness.

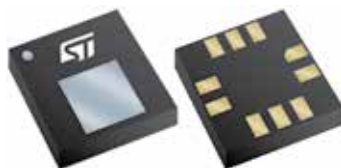

BENEFITS

- Ultra-small footprint
- Low-power consumption
- Fully-molded package ensure stability in any condition and water resistance

Part number	General description	Package (mm)	RMS Noise with embedded filter	Supply voltage min-max (V)	Current consumption (operating @ high resolution) typ (μA)
LPS22HB	260-1260 hPa absolute digital output barometer	HLGA-10L, 2 x 2 x 0.8	0.75 Pa		15

Note: a complete list of part numbers is available at www.st.com/pressure

HUMIDITY AND TEMPERATURE SENSORS

The HTS221 is an ultra-compact sensor that measures relative humidity and temperature. Housed in a tiny but robust HLGA package (2 x 2 x 0.9 mm), the HTS221 is suitable for wearable and portable devices and all applications where comfort, health and safety might be negatively impacted by humidity and temperature variations.



BENEFITS

- Ultra-small footprint
- Low-power consumption to address wearable devices
- Allows customized calibration for best design flexibility

Part number	General description	Package	Supply voltage min-max (V)	Humidity (RH) min-max (% RH)	Interfaces
HTS221	Capacitive digital sensor for relative humidity and temperature	HLGA-6L 2 x 2 x 0.9 mm	1.7-3.6	0-100	SPI, I ² C

MEMS MICROPHONES

Voice control is a wide spreading trend across many portable applications, making the interaction easier, faster and smoother. It enables fashionable designs by reducing the number of buttons.

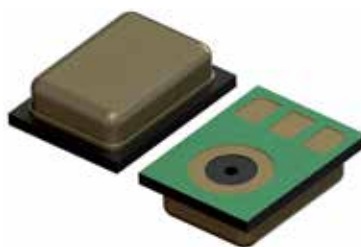

KEY FEATURES

- Tiny packages
- Low power consumption
- High performance
- Solution to integrate more sensors in a single package

Part number	Sensitivity (dBV)	SNR (dB)	AOP (dB)	Supply voltage range (V)	Supply current (μA)	Output	Package (mm)
MP23AB01DH	-38±1	65	135	2.3÷3.6	220	PDM, Differential	RHLGA metal cap 2.5 x 3.35 x 0.98

TIME-OF-FLIGHT PROXIMITY SENSORS



ST time-of-flight proximity and ranging sensors are based on FlightSense™ technology, which offers unique advantages:

- Absolute and accurate distance measurement in mm, whatever the target reflectance, material and color, unlikely traditional IR sensors which cannot output a distance and are highly impacted by the characteristics of the target
- The smallest ToF sensor on the Market today, which allows effective Industrial Designs

- Low power consumption
- Competitive system cost

FlightSense™ proximity sensors are greatly easing the product integration, since they are packaged in a single module which integrates the Time-of-Flight SPAD sensor (Single Photon Avalanche Diode), the ALS (Ambient Light Sensor) as well as the IR light source (VCSEL Vertical Cavity Surface-Emitting Laser).

Part number	General description	Key features
VL53L0X	The smallest time-of-flight (ToF) ranging sensor on the market today enabling fast and accurate measurement of longer distances up to 2 m	<ul style="list-style-type: none"> • Accurate range measurement up to 2 meters, independent of target reflectance • Very fast (up to 50 Hz) • Small form factor, easy integration • Low Power for battery operated devices
VL6180X	A proximity sensor, ambient light sensor (ALS) and IR light source in a single integrated module	<ul style="list-style-type: none"> • Proximity sensor, indicating actual distance from 0 to 40 cm typical • Ambient Light Sensor: 0 to 100 k Lux • Basic but robust gesture recognition • Low power: Standby <1 µA, Low Power ranging 60 µA • Module including Laser class1 IR emitter

TEMPERATURE SENSORS

STMicroelectronics' temperature sensors include both analog and digital temperature sensor ICs.

DIGITAL TEMPERATURE SENSORS BENEFITS

- One-shot mode for power saving
- Dual alarm
- Tiny package
- Programmable resolution
- Low supply current



ANALOG TEMPERATURE SENSORS BENEFITS

- Ultra small package: UDFN-4L (1 x 1.3 mm)
- Ultra-Low supply current: 4.8 µA typ.
- Oper. temperature: -55°C to 130°C



Part number	Package	General description	I/O Interface	Operating voltage min-max (V)	Standby current (µA typ)	Operating current (µA typ)
STTS751	UDFN-6L (2 x 2 mm)	2.25 V low-voltage local digital temperature sensor	SMBus/I ² C compatible	2.25-3.6	3	15
STLM20	UDFN-4L (1 x 1.30 mm)	Ultra-low current 2.4 V precision analog temperature sensor	-	2.4-5.5	-	4.8



Signal conditioning

ST's product portfolio contains a large range of op amps, comparators and current-sense amplifiers.

In addition to our broad portfolio of mainstream devices, ST offers a range of high-performance products specifically designed to meet the tight requirements of the wearable market.

The main features of our growing portfolio are:

- Low power
- High precision
- Tiny packages

OPERATIONAL AMPLIFIERS

Analog sensors need signal transducers to deliver the information for digital processing. ST offers a dedicated set of operational amplifiers suitable for wearable devices with excellent features.



KEY FEATURES

- Very high accuracy and stability
- Low supply voltage and low power consumption for battery operation
- Rail-to-rail inputs and outputs
- High tolerance to ESD
- Extended temperature range
- Tiny packages

Part number	Number of channels	Input offset voltage (mV) @ 25 °C Max	Input bias current (pA) typ @ 25°C	Supply current x channel (µA) Typ	Supply voltage (V) @ 25 °C	$\Delta V_{io}/\Delta T$ ($\mu V/^{\circ}C$) Max	GBWP (kHz) Typ	Package (mm)
OA1NP	1	3	1	0.6	1.5 to 5.5	5	8	SC70-5 (2.0 x 2.1 x 0.9)
OA2NP	2	3	1	0.6	1.5 to 5.5	5	8	DFN8 (2.0 x 2.0 x 0.75) MiniS08 (3.0 x 4.9 x 1)
OA4NP	4	3	1	0.6	1.5 to 5.5	5	8	QFN16 (3.0 x 3.0 x 0.9)
OA1MPA	1	0.2	1	9	1.5 to 5.5	10	120	SC70-5 (2.0 x 2.1 x 0.9)
OA2MPA	2	0.2	1	9	1.5 to 5.5	10	120	DFN8 (2.0 x 2.0 x 0.75) MiniS08 (3.0 x 4.9 x 1)
OA4MPA	4	0.2	1	9	1.5 to 5.5	10	120	QFN16 (3.0 x 3.0 x 0.9)
OA1ZHA	1	0.05	50	28	1.8 to 5.5	0.03	400	SC70-5 (2.0 x 2.1 x 0.9)
OA2ZHA	2	0.05	50	28	1.8 to 5.5	0.03	400	DFN8 (2.0 x 2.0 x 0.75) MiniS08 (3.0 x 4.9 x 1.1)
OA4ZHA	4	0.05	50	28	1.8 to 5.5	0.03	400	QFN16 (3.0 x 3.0 x 0.9)
TSU111	1	0.15	1	0.9	1.5 to 5.5	1.4	10	DFN6 1.2 x 1.3 SC70-5 (or SOT323-5)

CURRENT SENSORS

Dedicated to battery and power management, the current sensors enable precise and best current measure with a low current consumption budget.



KEY FEATURES

- Up to 70 V line monitoring
- Independent supply and common mode voltages
- Selectable gains
- Low power

Part number	Common mode operating range (V)	Current consumption (μA) Typ	Gain (V/V)	Temperature range ($^{\circ}\text{C}$)	Supply voltage (V)	Package (mm)
CS30	2.8 to 30	165	20, 50, 100	-40 to 125	4 to 24	SOT23-5 (2.9 x 2.8 x 1.2)
CS70	2.9 to 70	200	20, 50, 100	-40 to 125	2.7 to 5.5	TSSOP8 (6.4 x 3.0 x 1)

HOW TO MAKE YOUR SELECTION?



The ST Op Amps App is a free all-in-one design toolkit and smart selector for smartphones and tablets. You can select the best product from among our operational amplifier, comparator, current-sensing, power and high-speed amplifier portfolios.

You can also access to interactive schematics with smart component value calculator, access to 3D package data or access to datasheets while away from the desk.

The ST op Amps App is currently available on GooglePlay and AppStore.

www.st.com/oppamps-app



ANALOG SWITCHES

In portable devices, switches are used to route a great variety of signals such as audio to speakers/headphones or other signals to and from sensors. ST's analog switch line-up is meant to cover all the possible signal typologies from audio to USB.

KEY FEATURES

- Ultra-low power dissipation
- Low on-resistance
- Wide operating voltage range
- USB (2.0) high-speed (480 Mbit/s) signal switching compliant
- Integrated fail-safe function
- Tiny packages

Part number	Logical function	Propagation delay T_{phl} typ (ns)	Supply voltage (V)	Supply current (μA) Typ	Off Isolation (dB)	Package (mm)
AS11P2TLR	Single SPDT	0.13	1.65 to 4.5	0.1 (max)	-75 @ 100 kHz	DFN6L (1.2 x 1 x 0.5)
AS21P2TLR	Dual SPDT	0.3	1.65 to 4.3	0.05	-66 @ 100 kHz	QFN10L (1.8 x 1.4 x 0.5)



Microcontrollers

STM32 AND STM8 WIDE CHOICE OF SOLUTIONS FOR WEARABLE DEVICES



By choosing one of ST's microcontrollers for your embedded application, you gain from our leading expertise in MCU architecture, technology, multi-source manufacturing and support. ST's product portfolio contains a comprehensive range of microcontrollers, from robust, low-cost 8-bit MCUs up to 32-bit ARM®-based Cortex®-M0 and M0+, Cortex®-M3, Cortex®-M4 and Cortex®-M7 Flash microcontrollers with a great choice of peripherals. Leveraging its wide and market-proven portfolio, ST offers a selection of STM32 and STM8 microcontrollers perfectly fitting wearable devices.

- Wide range of processing performance
- Low power and energy efficiency
- Multiple and flexible power modes
- Wide voltage operation range
- Batch Acquisition Mode (BAM)
- LCD drivers
- Serial Audio Interfaces
- RTC with Calendar
- Multiple peripherals
- Advance analog features
- WLCSP packages
- Small and thin UQFN packages

8-bit MCUs

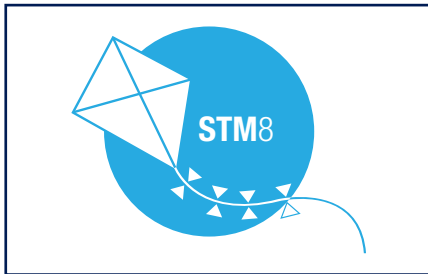

32-bit MCUs



Ultra-low-power

Mainstream

High-performance

How to make your selection?

The ST MCU Finder is a free app for mobile and desktop application, guiding you through the portfolio of more than 700 STM32 and STM8 MCUs, to select the best fit for your application. The selection results can be shared and technical features and documentation can be instantly accessed. An integrated feed provides up-to-date worldwide and local news around STM32 and STM8 MCUs. Supported languages are English, Chinese and Japanese.

The ST MCU Finder is currently available on GooglePlay and AppStore.

www.st.com/stmcfinder



STM32L AND STM8L - ULTRA LOW POWER MCU FAMILIES



A complete microcontroller offer including ultra-low-power STM32L as well as high-performance and power-efficient STM32F401/411 to address sensor hub applications in smartphones, tablets and wearable devices. STM32 sensor hub microcontrollers enable low power, low latency sensor fusion and implements an innovative Batch Acquisition Mode (BAM) allowing ultra-low-power sensor data acquisition. The application range is wide and covers from simple activity monitoring bands implementing a single accelerometer up to smartphones with 9-axis accelerometer, gyroscope & magnetometer combined with environmental sensor and audio with MEMS microphones.

- STM32 sensor hub microcontrollers are available with 3rd party motion processing libraries including Always-on sensor fusion, gesture recognition, activity & sleep monitoring, context awareness and indoor navigation with map matching on both Android™ and Windows® platforms.

KEY FEATURES

- Cortex®-M0+, M3 and M4 devices
- Up to 100 MHz with FPU
- Up to 125 DMIPS, 339 CoreMark
- Up to 1 Mbyte of Flash memory and 320 Kbytes of RAM
- Batch Acquisition Mode (BAM)
- Current down to 36 µA/MHz in Run mode
- Current down to 300 nA in Stop mode
- I²C, SPI/I²S, USB, USART, SDIO
- ADC, DFSDM (PDM to PCM)
- Down to WLCSP25 to 2x2.2mm

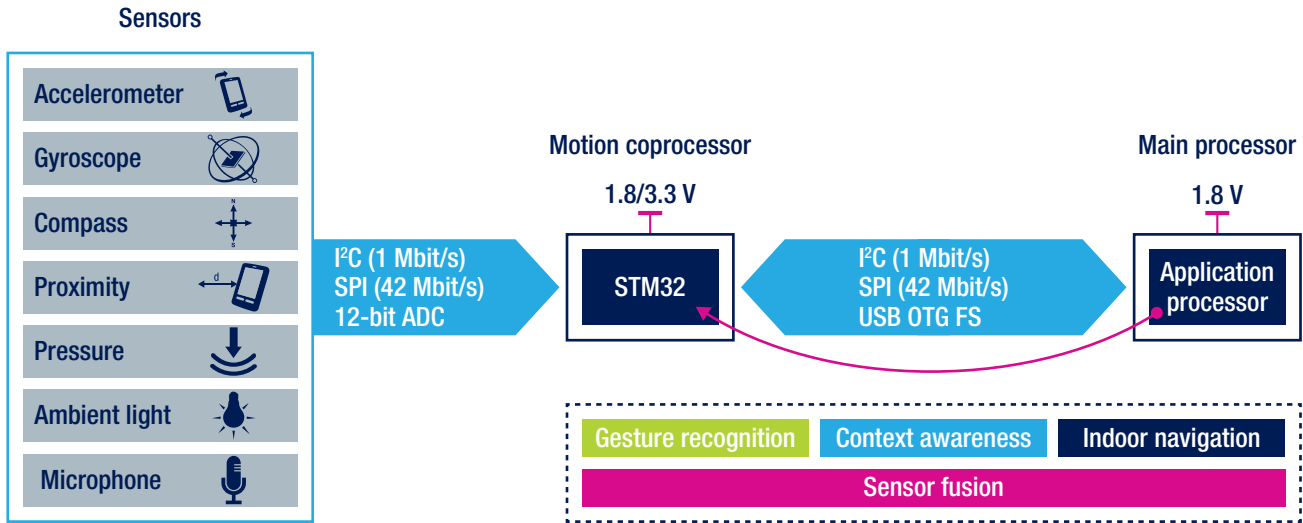

STM32 Dynamic Efficiency™
 Less dynamic power
 More performance



STM32L
 Ultra-low-power MCUs



STM32 – THE REFERENCE IN ADVANCED GRAPHIC USER INTERFACES

Enhanced user experience with the Chrom-ART Accelerator™



STM32 high-performance and Ultra - low-power products take full advantage of ST's proprietary Chrom-ART Accelerator™ to offer advanced graphic capabilities with minimum processing overhead.

Through the combination of processing acceleration, rich connectivity and optimized architecture, STM32 MCUs can handle both the demanding real-time processing and enhanced GUI that would otherwise require even more powerful – and more power-hungry – processors.

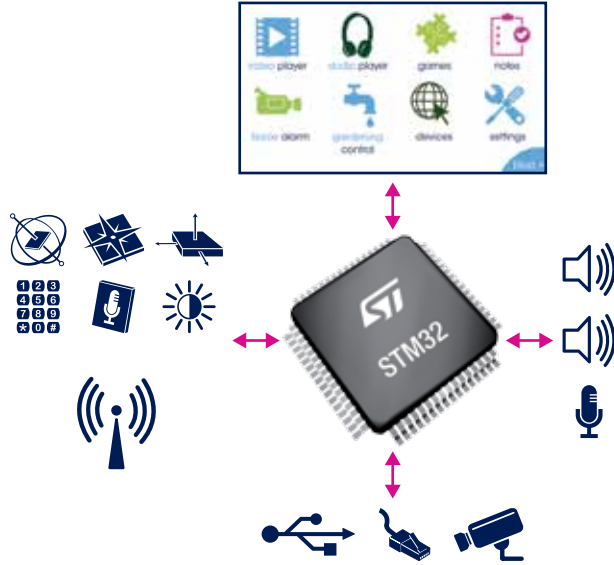

KEY FEATURES

- Chrom-ART Accelerator™ enabling efficient 2D copy, transparency effects and pixel format conversion independently from the main CPU
- MIPI-DSI controller supporting up to 720 p / 30 Hz resolution
- TFT-LCD controller supporting up to XGA resolution
- LCD parallel interface supporting 8080/6800 modes
- Power efficiency
- Maximum integration

Support for the most advanced display technology

ST introduced the world's first MIPI-Display Serial Interface (DSI) -enabled microcontroller, opening the door to the most advanced displays from the mobile phone industry with higher pixel density and lower power consumption. Efficiently combining the Chrom-ART Accelerator™ and the new MIPI-DSI interface, ST's latest STM32 high-performance microcontrollers enable high resolution and enhanced user experience in the smallest product form factors.

Rich graphic ecosystem

The STM32 ecosystem offers a large choice of advanced graphic libraries taking the full advantage of the Chrom-ART Accelerator™ and simplifying your GUI design.



STM32 – THE REFERENCE IN AUDIO AND VOICE

Low-power audio DSP replacement



STM32L4 ultra-low-power and STM32F4 Dynamic Efficiency™ product lines combine advanced processing capabilities, outstanding low power consumption and maximum integration to offer the ideal low-power audio and voice solutions for wearable

applications.

Leveraging ST's proprietary ART Accelerator™, the two product lines achieve zero wait state execution from internal Flash memory and deliver the full processing capabilities of the Cortex-M4 core running at up to 80 and 100 MHz. The Cortex-M4 DSP instruction set and the embedded floating point unit boost the performance capabilities, enabling advanced audio processing.

STM32L4 ultra-low-power and STM32F4 Dynamic Efficiency™ access lines achieve an outstanding 100 µA/MHz power consumption in Run mode and offer a Batch Acquisition Mode (BAM) enabling extended battery life by exchanging batches of data through communication peripherals while maintaining the rest of the system, including the CPU, in power-saving modes.

- 100/125 DMIPS
- DSP & FPU
- 100 µA/MHz in Run mode
- Batch Acquisition Mode
- Maximum integration

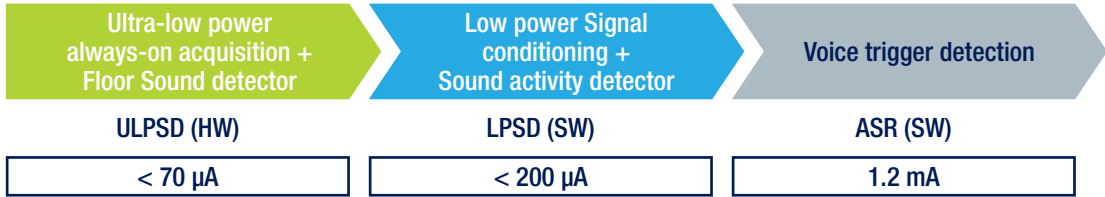

Wide range of processing performance, connectivity features and optimized software

ST's scalable STM32 microcontroller portfolio offers a wide range of processing performance and embedded SRAM sizes to meet a large number of audio application requirements. In addition, STM32 microcontrollers embed numerous audio interfaces with I²S, TDM and PDM support as well as audio dedicated PLLs to achieve audio accuracy.

STM32 microcontrollers also offer rich connectivity features with USB, SDMMC, camera, and display interfaces to meet the requirements for the most advanced applications.

Equally important, the STM32 software ecosystem facilitates the development of audio and voice applications by providing optimized internal and third-party audio software as well as hardware kits for prototyping. The software offer includes internal voice and audio codecs with MP3, AAC, WMA, Speex, ADPCM, G711 and G726 support. It also includes synchronization software, as well as audio post-processing solutions with SRC, equalization, bass management, smart volume control and visualization. The STM32 ecosystem also gives access to a wide range of optimized third-party software including voice command solutions.



STM32 AND STM8 – THE REFERENCES IN TOUCH SENSING AND WIRELESS

STM32 and STM8L families: Integrated touch-sensing functions



Certain STM32 microcontrollers feature a full hardware touch-sensing acquisition module based on self-capacitance technology. These devices include several I/Os (up to 24 channels)

for integrating multiple touch keys and providing developers with a single-device solution.

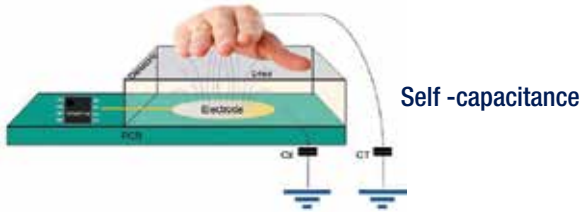

- Microcontroller-based I/Os internally coupled to touch sensing controller with up to 24 channels
- Touch sensing acquisition < 5% CPU load. Based on charge transfer acquisition
- Free-of-charge software libraries (C source code, firmware examples)
- Adapted development tools: STM-STUDIO STM32CubeMX and STM8CubeMX

STM8 - STM32 families: Wireless charging system

From basic waveform generation for low-end devices up to complex waveform generation, our MCU mainstream series ensures extreme flexibility for the digital control of the coil.



Timers with flexible PWM generation, dead time management or complemented output.

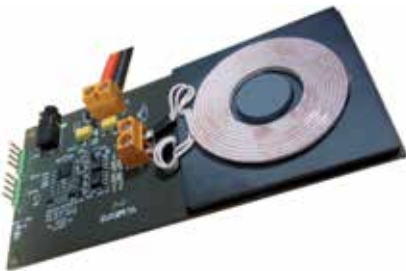

- ARM Cortex-M4 + FPU at 72 MHz – 90 DMIPS
 - From 16 to 512 Kbytes of Flash memory
 - Mixed-signals: CCM-SRAM, 16-bit ADC $\Sigma\Delta$, HR-timer...
- ARM Cortex-M3 at 72 MHz – 61 DMIPS
 - From 16 Kbytes to 1 MB byte of Flash memory
 - STM32 foundation: USB, Ethernet, CEC...
- ARM Cortex-M0 at 48 MHz – 38 DMIPS
 - From 16 to 256 Kbytes of Flash memory
 - Entry-level, cost-sensitive: 32-bit MCU at 32 cents, USB, CAN...
- STM8 core at 24 MHz
 - From 4 to 128 Kbytes of Flash memory, plus E²Data
 - Robust and reliable for basic functions
- STM8 core at 16 MHz
 - From 2 to 64 Kbytes of Flash memory
 - Low voltage operation and reduced power consumption

STM32 AND STM8 – THE REFERENCES IN POWER MANAGEMENT

STM8L family: 8-bit ultra-low-power MCU family

The STM8L, based on the 8-bit STM8 core, benefits from our proprietary ultra-low-leakage process, shared with the STM32L family, and features an ultra-low power consumption of 0.30 μA with the lowest power mode.



- Entry-level in ultra-low-power performance
- Targeting cost-sensitive applications



- Ultra-low-power market-proven solutions
- Best in class in ultra-low-power performance

STM32L family: the 32-bit ultra-low power mcu family

ST's ultra-low-power MCU platform is based on a proprietary ultra-low-leakage technology. STM32L0 (ARM® Cortex®-M0+), STM32L1 (Cortex-M3), STM32L4 (Cortex-M4) and the STM8L (8-bit proprietary core) represent a large range of devices addressing devices supplied from batteries or through energy harvesting and grant an optimized cost/performance ratio in all kinds of low-power applications.

This ultra-low-power platform with the industry's lowest current variation between 25 and 125 °C warrants outstandingly low current consumption at elevated temperatures. The MCUs reach the industry's lowest power consumption of 350 nA in Stop mode (with SRAM retention), while maintaining the wakeup time as low as 3.5 μs .

The new STM32L4 is the convergence of the ultra-low-power and high performance providing 100 DMIPS with DSP instructions and floating point unit, more memory (up to 1 Mbyte of Flash) and innovative features.

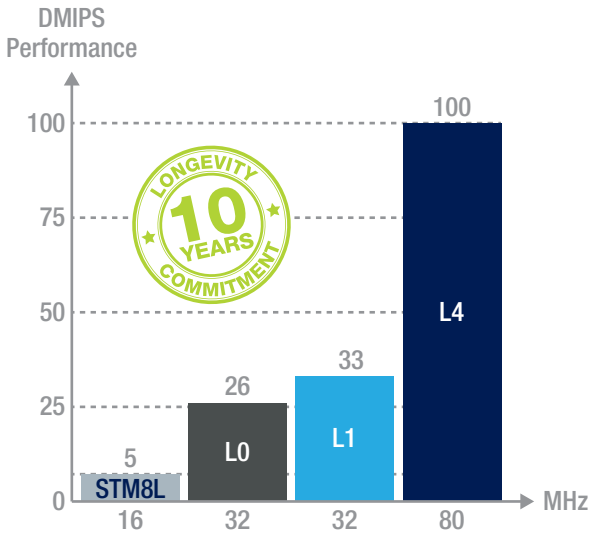

- 32-bit ARM Cortex-M4 + FPU at 80 MHz
- From 128 Kbytes to 1 Mbyte of Flash memory
- Lowest power mode + RAM + RTC: 0.45 μA



- 32-bit ARM Cortex-M3 at 32 MHz
- From 32 to 512 Kbytes of Flash memory
- Lowest power mode + RAM + RTC: 1.2 μA



- 32-bit ARM Cortex-M0+ at 32 MHz
- From 8 to 192 Kbytes of Flash memory
- Lowest power mode + RAM + RTC: 0.67 μA



- 8-bit STM8 core at 16 MHz
- From 2 to 64 Kbytes of Flash memory
- Lowest power mode + RAM +RTC: 0.3 μA



STM8CubeMX AND STM32CubeMX POWER CONSUMPTION CALCULATOR WIZARD



With STM8CubeMX and STM32CubeMX configuration and initialization C code generators, select your chip and configure its peripherals and power supply. Then use its Power Consumption Calculator wizard to define a sequence of steps representing your application and analyze its power consumption and battery life results.

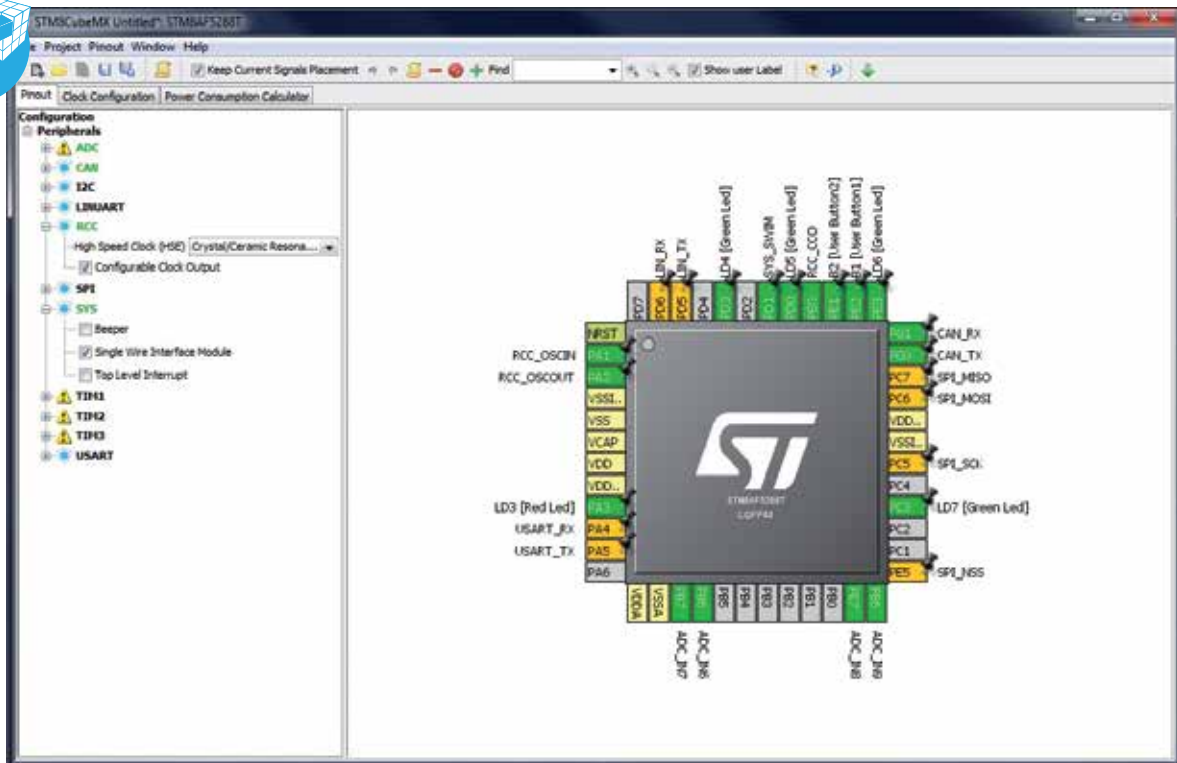
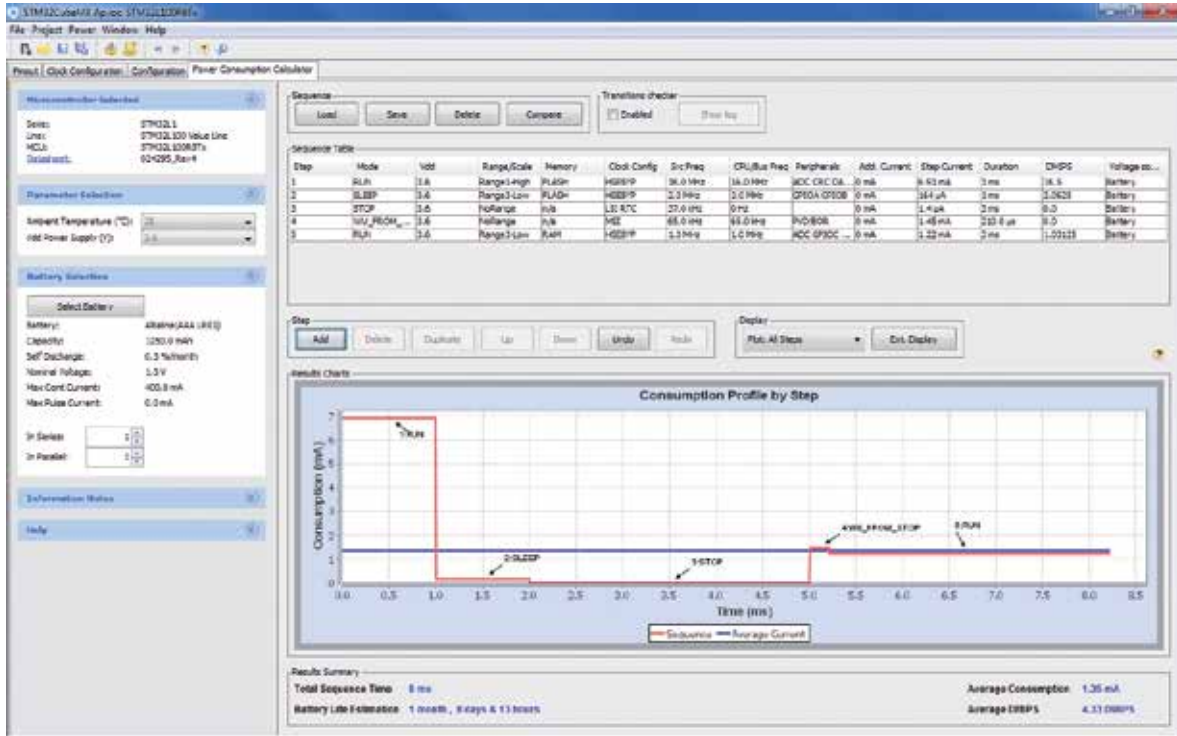



Security

SECURE ELEMENT AND INTEGRATED NFC BOOSTED SOLUTIONS FOR WEARABLE DEVICES

Wearable makers are facing multiple challenges to integrate secure contactless applications. They have to carefully address two main domains such as “Security” and “Contactless communication” to build a best-in-class wearable device.

ST platform security approach enables customers with a large choice of products and solutions for wearable applications such as payment, transport, and multiple contactless transactions answering the challenges such as Security certification, interoperability, power consumption, integration, and NFC highest performances.

BENEFITS

- Off line payment thanks to tamper proof Secure Element
- Enhanced user experience (reading distances)
- Allows ultra-small antenna
- Minimize footprint & ease integration



Security
Know-how Architecture



User experience
Reading distances



Certification
Cost Know-how



Interoperability



Secure solution



Wearable



Boosted NFC



Footprint & ease integration
BOM optimization
Flexible antenna design
HW/SW & qualification



Worldwide access
Various payment ecosystem / region



Remote management
Activation / Deactivation
Creation / Destruction



Power consumption

SECURE ELEMENT

The ST31 secure microcontroller family is the platform for highly-secure applications including banking, identification, pay TV, and transport.

With the ARM® SecurCore® SC000 processor and an architecture optimized for contactless performances, the ST31 offers a broad portfolio including MIFARE Plus® and MIFARE® DESFire® libraries, multiple interfaces, and certified cryptographic libraries.

ST31 dual interface secure microcontrollers are designed to enable secure and fast contactless transactions. They support various multiprotocol RF interfaces enhancing multi-application versatility. ISO/IEC 14443 Type A, B and B', NFC, ISO/IEC 18092 and Very High Bit Rate protocols are all available and Auto-detect mode allows automatic detection and dynamic adaptation of the device to the correct reader protocol. Combined with STS3922 booster, it meets all the requirements to support wearable payment/ transport applications with very small antennas.

ST33 secure microcontroller is designed to meet advanced security and performance requirements for secure application including NFC embedded secure element with a large user Flash memory capability. Combined with the ST's NFC controller ST21NFC, it meets all the requirements for the integration of the wearable payment, transport or multi-application in wearable device.

KEY FEATURES

- 32-bit ARM SC000 CPU/ SC300 CPU
- Multi-protocol (ISO7816, ISO14443 A:B/F, VHBR)
- EMVCo and Common Criteria certified

Part number	Secure device	NFC Mode	RF Protocol	Interface	Key features	Package
ST31G480	eSE 480 kB	Card Emulation	ISO 14443 A, B, B' – ISO 18092, VHBR	ISO 7816 ISO 14443	32-bit ARM® SecurCore® SC000 CPU eSE for payment, transport, access control MIFARE® Classic & DESFire® Available with or without STPay Payment application Ideal for contactless payment integration in battery-less wearables	DFN Bare die
ST33G1M2	eSE 1.2 MB	Card emulation / reader / P2P combined with NFC controller	Managed by NFC controller	ISO7816, SPI, SWP	32-bit ARM® SecurCore® SC300 CPU eSE for payment, transport, access control MIFARE® Classic & DESFire®	Wafer DFN8 4.2 * 4 WLCSP
ST33J2M0	eSE 2 MB	Card emulation / reader / P2P combined with NFC controller	Managed by NFC controller	ISO7816, SPI, I²C, SWP	32-bit ARM® SecurCore® SC300 CPU MIFARE® Classic & DESFire®, FeliCa® combining eSE and eSIM	Wafer QFN20 WLCSP

NFC BOOSTER AND NFC CONTROLLER SOLUTIONS

ST NFC booster (STS3921/22) and NFC controller (ST21NFC) solutions, implementing Active Load Modulation technology guarantee NFC transactions on wearables in challenging metallic environment or with a very small antenna. The key benefits of these product families are to:

- Simplify the software integration: Compatible with most operating systems on the market (Linux, Android, RTOS, ...). ST lowers the cost for developers by providing multi-application support with optimized solutions including intuitive SDK platforms for integrating contactless services around any microcontroller wearable device architecture
- Simplify the hardware integration: Reference designs, expansion boards, design guidelines
- Simplify the deployment: Integration into the most popular TSMs, pre-certification services to help reduce the time to market as well as development costs

KEY FEATURES

- Enhanced user experience (reading distance)
- Allows ultra-small antenna
- Minimize footprint & ease integration
- Increase interoperability
- Reach low power consumption

Part number	Type	NFC Modes	RF Protocol	Interface	Key features	Package
STS3921	Boosted NFC	Card Emulation	ISO14443A	Contactless bridge to Secure microcontroller chip SPI to Host	Active Load Modulation Q factor adjustment Automatic Power Control, Automatic Gain Control Low power field detection	WLCSP
STS3922	Boosted NFC	Card Emulation	ISO14443A	Contactless bridge to Secure microcontroller chip SPI to Host	Active Load Modulation Automatic Antenna Tuning Q factor adjustment Automatic Power Control, Automatic Gain Control Low power field detection	Bare die
ST21NFC	NFC Controller	Card Emulation/ reader/P2P	ISO14443A/B ISO18092 ISO15693	SWP SPI, I²C, UART	Active Load modulation Optimized power consumption modes NFC 2.0 compliant Secure Firmware update mechanism	BGA64 4*4

INTEGRATED SOLUTION

From ST31 Secure Microcontroller, STPay and ST33 to full blown NFC solutions based on ST53 and ST54 family, ST offers a complete range of turnkey solutions pre-certified for most payment and transit schemes (EMVCo, PBOC, VISA, MC, AMEX, Discover, MIFARE®, ...).

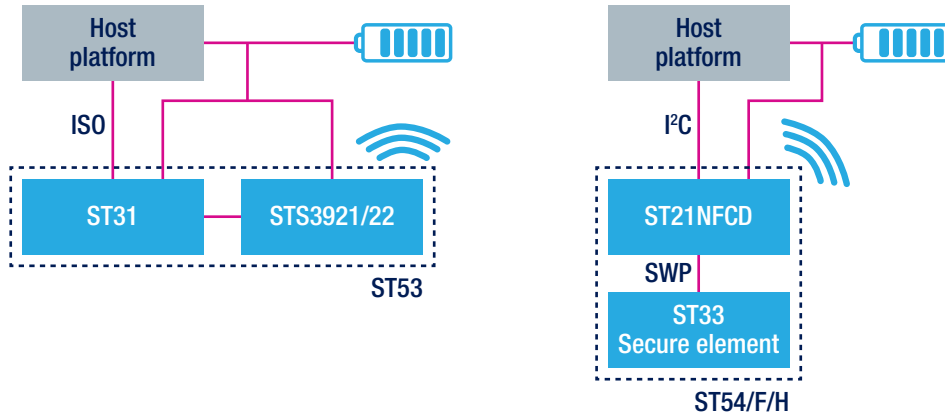

Part number	SE integrated	Contactless frontend	Targeted devices	Package
ST53	ST31G480	STS3922	Ideal for single/dual contactless applications Ideal for low and middle-end wearables Available with or without STPay Payment application	BGA 4x4
ST54F	ST33G1M2	ST21NFCD	Support multiple secure applications Ideal for middle and high end wearables	BGA 4x4
ST54H	ST33J2M0	ST21NFCD	Support multiple secure applications and eSIM Ideal and to enable convergence of application such as eSIM & FeliCa®	BGA 4x4



Wireless connectivity

ST's portfolio offers a variety of wireless ICs and modules to address the needs of designers for their applications. Low-power wireless connectivity represents the key technology for connecting smart objects to the internet and the cloud. As a matter of fact, wireless connectivity is not dominated by one single technology. Depending on application needs or technology constraints, different hardware and software integration requirements must be considered.

WI-FI MODULE

SPWF04S is the latest cloud-compatible Wi-Fi module from STMicroelectronics, set to accelerate development of all kinds of IoT applications. The SPWF04S module, compliant with IEEE 802.11 b/g/n standard for the 2.4 GHz band and FCC/IC and CE (RED) certified, provides advanced Internet-security and application protocols, and features a microcontroller capable of supporting operation in standalone or serial-to-Wi-Fi modes. The SPWF04 Wi-Fi module integrates an ARM® Cortex®-M4 STM32 microcontroller with a rich set of multi-functional GPIOs and with 2 MB on-chip Flash and 256 Kbyte RAM for generous code and data storage. Further extra features include a hardware cryptographic accelerator and an SPI port for faster host communications. In addition, the new MicroPython scripting engine dramatically simplifies development of custom applications to run directly on the module in standalone mode. Host interactions can use AT commands via a UART, compatible with the previous generation of Wi-Fi modules, or equivalent proprietary protocol over SPI. Support for strong internet-security protocols includes WPA2-Enterprise, which enables enhanced authentication and access control in large networks, and Wireless Protected Setup (WPS) that helps safely connect devices like printers or embedded systems. There is also support for advanced HTTPS and encryption protocols including Transport Layer Security (TLS), as well as Secured Over-The-Air (OTA) updates for applying software, firmware, or Flash file-system upgrades in the field via the Wi-Fi connection

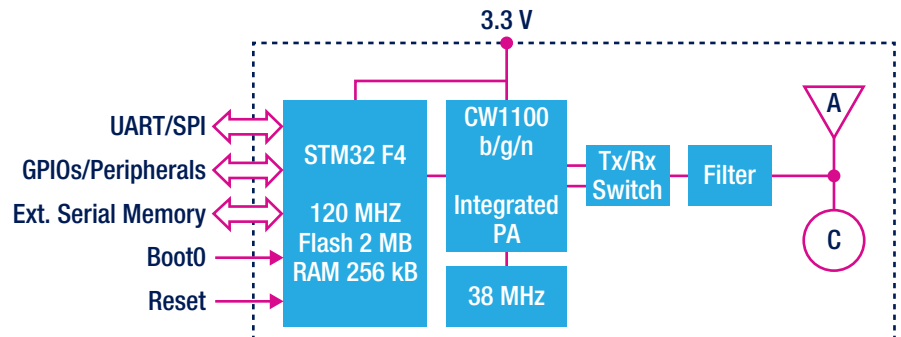

Order code	Antenna Option	Application Mode	Storage Option	Supply voltage typ (V)	I/O Level voltage (V)	Output power (dBm)
SPWF01SA.11	Integrated Antenna	AT Full Stack	Extended Flash	3.3	2.5	0 to 18
SPWF01SC.11	Integrated U.FL connector					
SPWF01SA.21	Integrated Antenna		-			
SPWF01SC.21	Integrated U.FL connector					
SPWF04SA	Integrated Antenna	AT Extended Stack, high throughput SPI protocol, host-less MicroPython environment	User Flash, External Flash / SDCard	3.3	3.3	
SPWF04SC	Integrated U.FL connector					

SPBT3.ODP1 AND SPBT3.OPD2 BLUETOOTH® 3.0 CLASSIC MODULE

The SPBT3.ODP series are the new Bluetooth® 3.0 Classic module offers a fast, flexible and affordable Plug&Play solution. SPBT3.ODPx is an evolution and upgrade of the existing SPBT2632Cx series of Bluetooth classic modules giving incremental value to ST offer.

The SPBT3.ODP usable using AT command and implement the follow application Profile: Serial Port, rofile (SPP), HID (Human Interface Devices) and iAP2 (Apple iOS); these module are fully FCC, IC and CE (RED) certified

The SPBT3.ODP1 and SPBT3.ODP2 are implementing respectively Class 1 and Class 2 Bluetooth® 3.0 Classic.

SPBT3.ODP1

- TX Power: +10.77 dBm.
- RX Sensitivity: -88 dBm
- Size: 15 x 27 mm



SPBT3.ODP2

- TX Power: +2.6 dBm.
- RX Sensitivity: -86 dBm
- Size: 11.6 x 13.5 mm

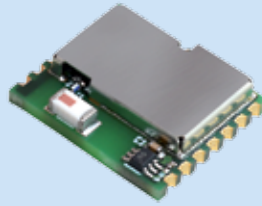

Order code	Description
SPBT3.ODP1	Bluetooth® V3.0, Class1, antenna, AT DP command FW
SPBT3.ODP2	Bluetooth® V3.0, Class2, antenna, AT DP command FW

BlueNRG PRODUCT FAMILY FOR BLUETOOTH 4.x



The BlueNRG product family is the ST solution for Bluetooth Low Energy connected devices, enabling the most convenient wireless connectivity with Smartphones and Smart Apps.

BlueNRG devices offer excellent low-power efficiency and top-notch radio performances. The unmatched energy efficiency due to its ultra-low power consumption as well as its ultra-fast state transition speed between low-power and active states, greatly extending battery life from month to years. In addition, RF-output power is boosted up to +8 dBm to ensure clear and reliable communication even in noisy environments.

BlueNRG-MS is the Bluetooth Low Energy network processor, compliant with Bluetooth 4.1 core specifications, and able to support master and slave roles simultaneously. BlueNRG-MS gives designer the flexibility to choose their preferred host microcontroller to run the application.

BlueNRG-1 is ST's first Bluetooth Low Energy Application Processor compliant with 4.2 core specifications. It is based on a 32-bit ARM® Cortex®-M0 running at 32 MHz and embeds

160 Kbyte of on-chip flash, 24 kB RAM, 10-bit Analog/Digital Converter, GPIOs and standard I/O peripherals such as SPI, I²C and UART. Also, a Pulse-Digital Modulation (PDM) interface allows to capture voice directly from a digital MEMS microphone, suitable for voice-commanded applications.

BlueNRG-1 provides a single-chip solution perfectly suited for size-constrained wearable application and IoT objects. The entire product family offers easy firmware upgrades in the field through an OTA (Over-the-Air) mechanism, a perfect solution for IoT applications.

BlueNRG-2 is the new generation of the 4.2 Bluetooth® Low Energy (BLE) System-on-Chip, based on 32-bit ARM® Cortex®-M0 and integrating 256 KB of Flash memory, 24 kB RAM and the same set of peripherals of BlueNRG-1. In addition, the latest evolution of the BLE stack adds state-of-the-art security and privacy communication along with a faster data transfer.

BlueNRG-2 offers a unique combination of low power consumption, scalable GPIO pins, with high radio performance, and large integrated memory, meeting all the needs of the smartphone-controlled IoT applications.

BLUENRG FAMILY KEY FEATURES

- Significantly extends battery life
- Robust and reliable RF connections
- Excellent co-existence performance in crowded 2.4 GHz bandwidth
- Full-featured SDK, with templates, examples and iOS/Android apps



Order code	System partitioning	Operating voltage (V)	Standby current typ (μ A)	RX current typ (mA)	TX current @ 0dBm output power (mA)	RX sensitivity typ (dBm)	Output power (dBm)	Operating temperature ($^{\circ}$ C)	Flash size (kB)	Package
BlueNRG-232	System On Chip	1.7 to 3.6	0.9	7.7	8.2	-88	+8	-40 to 105	256	VFQFPN32 - 5x5x1
BlueNRG-234	System On Chip									WLCSP - 2.66x2.56x0.5
BlueNRG-248	System On Chip									VFQFPN48 - 6x6x1
BlueNRG-132	Network Processor									VFQFPN32 - 5x5x1
BlueNRG-134	Network processor									WLCSP - 2.66x2.56x0.5
BlueNRG-MSQTR	Network Processor		-							
BlueNRG-MSCSP	Network processor	1.7	-40 to 85	-	WLCSP - 2.66x2.56x0.5					

COMPANION BALUNS

Part number	General description	Integrated harmonic filter	Insertion loss(IL) max (dB)	Operating frequency (f) min (GHz)	Operating frequency (f) max (GHz)	Package
BALF-NRG-01D3	50 Ω nominal input / conjugate match balun to BLUENRG and BLUENRG-MS	Y	1.1	2.4	2.5	WLCSP
BALF-NRG-02D3	50 Ω nominal input / conjugate match balun to BLUENRG-MS, BLUENRG-1 and BLUENRG-2	Y	1.3	2.4	2.5	WLCSP

VERY LOW POWER MODULE FOR BLUETOOTH® SMART V4.1

The SPBTLE-RF and SPBTLE-RF0 are easy-to-use Bluetooth® Smart master/slave network processor module compliant with Bluetooth® v4.1. Designed around ST's BlueNRG-MS network processor take advantage of its enhanced features to create a complete RF platform in a tiny form factor. Integrating radio, antenna, high frequency and LPO oscillators, the SPBTLE-RF and SPBTLE-RF0 offer certified (ETSI, FCC, IC) solutions to optimize the time to market of the final applications and to simplify the RF and wireless design, allowing engineers to concentrate on creating innovative IoT applications.

In particular the SPBTLE-RF0 module is a cost effective solution considering it is working with with internal cristal oscillator and Internal LDO (SMPS Off)

KEY FEATURES

- Significantly extends battery life
- Master, slave role support
- Bluetooth radio performance:
 - Embedded ST BlueNRG-MS
 - BQE End-Product qualified
 - Tx power: + 4 dBm
 - Rx sensitivity: -88 dBm
 - Link budget up to 92 dB with excellent link reliability
- Fully RF certified
 - ETSI Certified
 - FCC (RED)
 - IC
- Operating supply voltage: from 1.7 to 3.6 V
- Operating temperature range: -40 $^{\circ}$ C to 85 $^{\circ}$ C



Sub-1GHz TRANSCEIVERS



ST's RF transceivers are intended for operating in unlicensed and globally available Sub-1GHz frequency bands, guaranteeing robust and reliable communication.

The new ultra-low power sub-1 GHz transceiver **S2-LP** is the ideal solution for allowing smart connected object to operate for up to 10 years without replacing batteries, while the receiver sensitivity of -130 dBm enables connection over distances up to several hundred kilometers, depending on the environment, thus enabling wide-area coverage. It supports point-to-point, star, as well as mesh networking topologies thus resulting in a very flexible wireless transceiver for connected objects. Moreover the S2-LP enables connectivity to the Sigfox global network, which is being rolled out worldwide to provide a reliable cost- and energy-efficient communication solution for billions of sensors and smart things.

The S2-LP delivers extremely low power consumption, drawing only 6.7 mA in receive mode, and 10 mA when transmitting at 10 dBm. Sleep and standby modes reduce the current to just 600 nA and 350 nA, respectively.

S2-LP KEY FEATURES

- Frequency bands: 430-470 MHz, 860-940 MHz
- Ultra-low current consumption (7 mA RX and 10 mA TX @ +10 dBm)
- Excellent receiver sensitivity down to -130 dBm
- Enables operation in the SIGFOX™ networks QFN 24 4 x 4 package



The **SPIRIT1** transceiver is intended for RF wireless-sensor node applications in the Sub-1GHz band, such as Automatic Meter Infrastructure, alarm and security systems, home and building automation, and industrial monitoring and control. It combines excellent receiver sensitivity with a very low current consumption. Additional embedded features include a "Listen-before-talk" with CSMA/CA engine, AES-128-bit data encryption, error correction and detection, FIFO memory blocks, as well as a highly flexible and programmable data packet which contributes to further reducing the computational load of the host microcontroller and the overall system power consumption. SPIRIT1 is designed to operate within the ISM and SRD sub-1 GHz frequency bands namely at 169, 315, 433, 868, and 915 MHz. Several software stacks are available, such as the 6LoWPAN protocol stack enabling low-power devices to participate in the IoT.

SPIRIT1 KEY FEATURES

- Frequency bands: 150-174 MHz, 300-348 MHz, 387-470 MHz, 779-956 MHz
- Ultra-low current consumption (9mA RX and 21 mA TX @ +11 dBm)
- Excellent sensitivity -122 dBm @ 1.2 Kbit/s (1% BER)
- ETSI, FCC and ARIB compliant
- Wireless MBUS, 6LowPan
- QFN 20 4 x 4 package



COMPANION BALUNS

Part number	General description	Integrated harmonic filter	Insertion loss (IL) max (dB)	Operating frequency (f) min (GHz)	Operating frequency (f) max (GHz)	Package
BALF-SPI-01D3	50 Ω nominal input / conjugate match balun to SPIRIT1 for 868 MHz configuration	Y	2	779	956	WLCSP
BALF-SPI-02D3	50 Ω nominal input / conjugate match balun to SPIRIT1 for 433 MHz configuration	Y	3	390	470	WLCSP
BALF-SPI2-01D3	50 Ω / Conjugate match BALUN to SPIRIT2-LP for 868 MHz configuration	Y	1.7 (typ)	779	956	WLCSP
BALF-SPI2-02D3	50 Ω / Conjugate match BALUN to SPIRIT2-LP in 433 MHz configuration	Y	1.7 (typ)	390	470	WLCSP

SUB-GHZ MODULES

SP1ML-868 / SP1ML-915 modules

The SP1ML-868 and SP1ML-915 are ultra-low-power and fully integrated RF modules operating respectively in the 868 MHz SRD and 915 MHz ISM bands.

Thanks to their small compact size, on-board antenna and easy-to-use interface, these modules let you easily add wireless connectivity to your design without requiring in-depth RF experience. They also come with the necessary FCC modular approvals and CE compliance, reducing your time to market. These modules embed a SPIRIT1 RF transceiver with integrated SMPS, an STM32L1 ultra-low-power microcontroller, an integrated filter/balun and a chip antenna. The UART host interface ensures a simple connection to an external microcontroller using standard firmware with an AT command set for easy RF configuration, data transmission and reception.

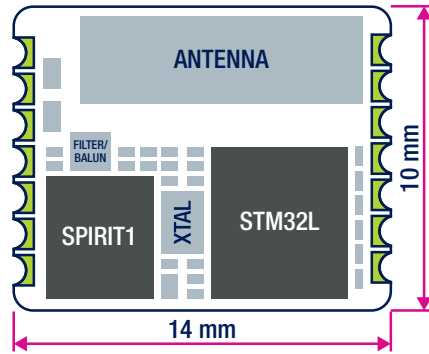

KEY FEATURES

- 1.8 V to 3.6 V supply - Low power consumption
- Output power up to +11.6 dBm
- Air data rates up to 500 kbit/s
- Operating temperature: -40 to 85 °C
- Standard firmware with AT command set, interface via UART for configuration and point-to-point RF data communication

SPSGRF and SPSGRFC Modules: 413, 868 and 915 MHz

The SPSGRF and SPSGRF-C are ultra-low-power sub-GHz modules based on ST's SPIRIT1 RF transceiver.

SPSGRF family is embedding chip antenna, family is including SPSGRF-868 and SPSGRF-915 operating respectively in the 868 MHz SRD and 915 MHz ISM bands.

SPSGRFC family is embedding UFL connector to connect external antenna to extend the transmission range; SPSGRFC family is including SPSGRFC-433, SPSGRFC-868 and SPSGRFC-915 operating respectively in the 433 MHz, 868 MHz SRD and 915 MHz ISM bands.

SPSGRF and SPSGRFC are totally firmware and pin to pin compatible.

These modules provide a complete RF platform for wireless connectivity in a tiny form factor and include 4 programmable I/O pins and SPI serial interfaces. Being an FCC, IC, and CE certified solution, the SPSGRF and SPSGRFC series reduces the time-to-market of end applications.

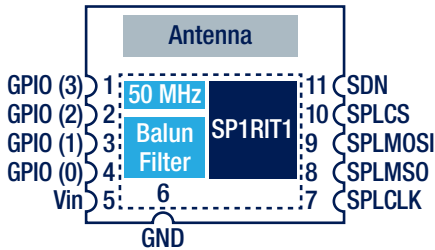

FEATURES

- Module based on:
 - SPIRIT1 low-data-rate, low-power sub-GHz transceiver
 - BALF-SPI-01D3 868/915 MHz balun with integrated harmonic filter
 - On-board antenna and crystal oscillator
- Modulation schemes: 2-FSK, GFSK, MSK, GMSK, OOK, and ASK
- Air data rate from 1 to 500 kbit/s
- Receiver sensitivity: -118 dBm

- Programmable RF output power up to +16 dBm
- 1.8 V to 3.6 V supply - Low power consumption
- RX: 9 mA, Tx: 21 mA @ +11 dBm

BENEFITS

- Add wireless capability to any electronic device without requiring RF experience
- Compact size
- CE (RED), FCC and IC certified

Baluns

ST's balun transformers and balanced filters integrate specific complex impedances for the main Bluetooth and Wi-Fi chips offered by major manufacturers. They boost RF performance and simplify RFIC to antenna implementation thanks to its highly integrated technology.

RF IC supplier	RF IC	Matched Balun	Frequency (MHz)	Integrated filter	Size	Package
STMicroelectronics	SPIRIT 1	BALF-SPI-01D3	868/915	Yes	1.4 mm x 2.0 mm	WLCSP
	SPIRIT 1	BALF-SPI-02D3	433	Yes	1.4 mm x 2.0 mm	WLCSP
	SPIRIT2-LP	BALF-SPI2-01D3*	868/915	Yes	2.1 mm x 1.55 mm	WLCSP
	SPIRIT2-LP	BALF-SPI2-02D3*	433	Yes	2.1 mm x 1.55 mm	WLCSP
	STLC2690	BALF-2690-02D3	2400	Yes	1.64 mm x 0.94 mm	WLCSP
	BLUENRG BLUENRG-MS BLUENRG-1	BALF-NRG-01D3 BALF-NRG-02D3*	2400	Yes	1.4 mm x 0.85 mm	WLCSP
Atmel	ATWINC1500A	BAL-WILC10-01D3	2400	No	0.95 mm x 0.95 mm	WLCSP
	ATSAMR21E8 AT86RF233 ATMEGA256	BALF-ATM-01E3	2400	Yes	2.00 mm x 1.25 mm	WLCSP
	CC1101	BAL-CC1101-01D3	868/915	No	2.0 mm x 1.0 mm	WLCSP
Texas Instrument	CC1120 CC1125	BALF-112X-01D3	868/915	Yes	1.95 mm x 1.87 mm	WLCSP
	CC1120 CC1125	BALF-112X-02D3	433	Yes	1.95mm x 1.87mm	WLCSP
	CC2540/43/45 CC2530/31/33	BAL-CC25-01D3	2400	No	0.9 mm x 0.9 mm	WLCSP
	CC2541	BALF-CC25-02D3	2400	Yes	0.9 mm x 0.9 mm	WLCSP
	CC2650/CC2640 CC2630/CC2620 CC2610	BALF-CC26-05D3	2400	Yes	0.9 mm x 0.9 mm	WLCSP
	nRF51822-QFAACx nRF51822-QFABAx nRF51422-QFAACx	BAL-NRF01D3	2400	Yes	1.5 mm x 1.0 mm	WLCSP
Nordic Semi	nRF51822-CTAx	BALF-NRF01J5*	2400	Yes	1.4 mm x 0.85 mm (height<350 μm)	Thin WLCSP
	nRF51822-CxAx nRF51422-CxAx	BAL-NFR02D3	2400	Yes	1.4 mm x 0.9 mm	WLCSP
	nRF51822-QFAAHx nRF51822-QFACAx nRF51422-QFAAFx nRF51422-QFACAx	BALF-NRF01E3	2400	Yes	1.5 mm x 1.0 mm	LGA
	nRF51822-QFAAGx nRF51822-QFABBx nRF51422-QFAAEx nRF51422-QFABAx	BALF-NRF01D3	2400	Yes	1.5 mm x 1.0 mm	WLCSP

Note: * Available Q3 2017

NFC & RFID

NFC/RFID Tags & Readers



ST offers a comprehensive portfolio of NFC/RFID products, which operate at 13.56 MHz frequency and are based on NFC and ISO standards:

- Dynamic NFC tags, featuring a reliable EEPROM memory with data protection (password), an I²C interface to connect to a MCU and a RFID/NFC tag interface, enabling multiple use cases for Consumer, Industrial and IoT
- NFC/RFID Tags, ideal for wireless pairing (Bluetooth or Wi-Fi) and product identification, feature counters, data protection (password) and able to wake-up the Host chip thanks to a General Purpose Output
- NFC/RFID Readers, which support multiple NFC protocols in Reader or Peer-to-Peer modes, accessed by SPI interface and able to cope with the most challenging environment thanks to High RF performances and advanced features

ST also offers a large range of discovery kits, Nucleo shields, reference softwares and documentations in order to ease the design process.

KEY FEATURES

- Best-in-class RF performances
- HF 13.56 MHz frequency
- High reliable EEPROM with data protection
- I²C/SPI serial interface
- Energy harvesting capabilities
- Tamper detection feature
- Automatic Antenna Tuning
- High and Dynamic Power Output

Part number	Mode	Protocol	Serial interface	Key features	Package
ST25R3911B ST25R3912 ST25R3913	Reader/Writer P2P	ISO14443A/B ISO15693 FeliCa	SPI	Automatic Antenna Tuning Dynamic Power Output (up to 1.4 W) Very High Baud Rate 6.8 Mbps Capacitive & Inductive wake-up	QFN32 (5x5 mm)
ST25R3910	Reader/Writer	ISO14443A/B ISO15693 FeliCa	SPI	Automatic Antenna Tuning Dynamic Power Output (up to 0.7 W) Inductive wake-up	QFN32 (5x5 mm)
CR95HF ST95HF	Reader/Writer Card Emulation	ISO14443A/B ISO15693 FeliCa	SPI	Power Output (up to 0.23 W) Inductive wake-up	QFN32 (5x5 mm)
ST25DV	Dynamic Tag	ISO15693	I ² C	EEPROM 4 kb, 16 kb & 64 kb Fast Transfer Mode (256 B buffer) 64-bit password Energy Harvesting GPO MCU wake-up	S08 TSSOP8 FPN8 FPN12
M24LR	Dynamic Tag	ISO15693	I ² C	EEPROM 4 kb, 16 kb & 64 kb 32-bit password Energy Harvesting GPO MCU wake-up	S08 TSSOP8 FPN8
M24SR	Dynamic Tag	ISO14443A	I ² C	EEPROM 4 kb, 16 kb & 64 kb 128-bit password GPO MCU wake-up	S08 TSSOP8 FPN8 Die
ST25TA	Tag	ISO14443A	NA	EEPROM 512 b, 2 kb, 16 kb & 64 kb 128-bit password 20-bit Counter GPO MCU wake-up	Die FPN5
ST25TV	Tag	ISO15693	NA	EEPROM 512 b, 2 kb & 64 kb 64-bit password Tamper Detect loop 20-bit Counter GPO MCU wake-up	Die FPN5

NFC Controller, NFC booster and Secure Element

Near field communication (NFC) technology is at the heart of an expanding spectrum of easy-to-use, intuitive, contactless applications. Integration of NFC is more and more common into wearables to enable contactless payment, transport and access control features.

STMicroelectronics provides a global offer of products and solutions for security and NFC enablement. This includes state-of-the-art NFC controllers, Boosted NFC solutions, and a set of secure 32-bit Flash-based microcontrollers to address embedded Secure Element (eSE). Solutions are delivered as discrete ICs, or system-in-package for optimized integration.

GPS/GNSS RECEIVERS

Teseo III is a GNSS positioning receiver family supporting GPS, Galileo, GLONASS, BeiDou, QZSS and SBAS systems



KEY FEATURES

- Best in class positioning accuracy
- Best stand-by current <10 uA
- Small footprint
- Smart power management

Part number	Voltage supply range	Peripherals	Options	Package
STA8090FG	1.6 - 4.3 V	#3 UARTs, USB, SPI, I ² C, SDMMC, PPS	FreeRTOS SDK offer	TFBGA99 5 x 6 x 1.2 mm 0.5 mm pitch
STA8090WG	1.6 - 4.3 V	#3 UARTs, USB, SPI, I ² C, PPS	GNSS ROM	WLCSP77 3.9 x 3.9 x 0.6 mm 0.4 mm pitch



Power management

High integration combined with a broad IP portfolio, complete system competency and state-of-the-art technology.

ST is a leading supplier in power management and mixed-signal ICs for mobile applications, offering a wide range of products from simple power management ICs up to highly-integrated devices that mix power management blocks with advanced analog and digital functionality.

LDOs	DC-DC converters	Battery management ICs
<ul style="list-style-type: none"> • Wide product selection • Unique bump-less technology allows the smallest form factor 	<ul style="list-style-type: none"> • High frequency high dynamic performance $f_{sw} = 6 \text{ MHz}$ • Buck-Boost converter with V_{out} up to 5.5 V 	<ul style="list-style-type: none"> • Advanced embedded features (power path, shipping mode, protection circuit module PCM) • EnFilm™ thin-film batteries • Battery monitoring
Smart reset	Energy harvesting	Wireless charging
<ul style="list-style-type: none"> • Customizable products providing safe and convenient reset 	<ul style="list-style-type: none"> • Energy harvested from PV and thermo-electric generator (TEG) • Smart power management architecture (Boost/Buck-boost based on the available energy source) 	<ul style="list-style-type: none"> • TX and RX architectures supported • Compliant with PMA and Qi standards

28

BATTERY MANAGEMENT

ST's battery management devices provide high efficiency, power density and low standby power consumption. Our product portfolio includes complete solutions for battery chargers: switching chargers that offer charge currents up to 1.2 A, integrating in the same chip a fuel gauge function; linear chargers with charge currents from 15 mA to 1.1 A and wireless chargers compliant with PMA and Qi standards. By combining wireless power technology with high efficiency and smart charging, ST creates easier, faster, innovative, ways to power up smartphones, tablets and other mobile devices.

Part number	General description	Operating temperature		Charge current (A)	Supply current (bat) typ (μA)	Supply voltage (V_{DD})		Package
		min ($^{\circ}\text{C}$)	max ($^{\circ}\text{C}$)			min (V)	max (V)	
L6924D	Single Cell Li Ion battery Charger	-40	85	1	0.25	2.5	12	VFQFPN 16
L6924U	Single Cell Li-Ion Battery Charger IC for USB port and AC Adapter	-40	85	1	0.25	2.5	12	VFQFPN 16
STBCFG01	Switch-mode Single Cell Li+ Battery Charger with OTG Boost, Voltage Mode Fuel Gauge and LDO	-40	85	-	10	3.78	5.95	Flip-Chip25
STNS01	Li-Ion Linear Battery Charger with LDO	-30	85	0.2	6	4.55	5.4	DFPN 12 3 x 3
STWBC	Digital controller for wireless battery charger (WBC) transmitters Qi 1.1.2 A11 certified, PMA compatible	-40	105	-	-	3	5.5	VFQFPN 32
STBC02	Li-Ion Linear Battery charger with LDO, Load Switches, Battery Protection and Reset Generator	-40	85	0.45	4	4.55	5.4	Flip-chip30
STBC03	Li-Ion Linear Battery charger with LDO, Load Switches and Battery Protection	-40	85	0.65	4	4.55	5.4	Flip-chip30
STBC15	Ultra-low current consumption linear battery charger for thin film and Li-ion Batteries	-40	85	0.04	0.25	3.2	6.5	QFN 12 Flip-chip12

Note: * in development

BATTERY MANAGEMENT

The combination of ST's STWBC-WA wireless charging-transmitter controller and STWLC04 wireless battery-charger receiver enables power transfers up to 1 W over a coil of only 11 mm in diameter on the receiver side and 20 mm on the transmitter side for slimmer form factors. Power-transfer capability can be increased to 3 W by using larger coils and a full-bridge circuit on the transmitter side. This fully-featured chipset supports wireless-charging for Li-ion or Li-polymer battery chemistries and provides safety mechanisms such as Foreign-Object Detection (FOD).

Transmitter STWBC-WA

- USB as power source
5 V input, up to 0.5 A
- Smart standby
- Automatic receiver recognition
- FOD for increased safety
- Minimal BOM thanks to half bridge architecture
- Configurable via API for application customization via GUI

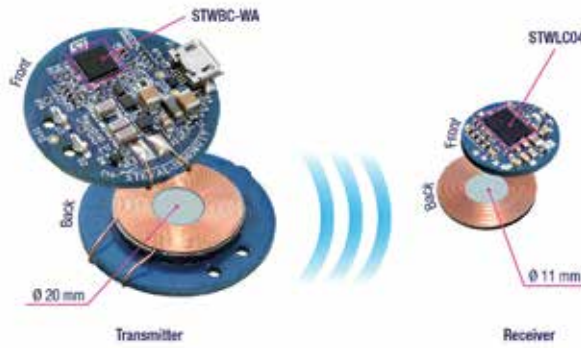

Order code: STEVAL-ISB038V1

Receiver: STWLC04

- 5 V fixed output voltage
- Li-Ion direct battery charging
- Space saving solution with optimized BOM
- Max. Z @ 1 W: 3 mm
- 43% total system efficiency with small coils
- Flip Chip 3.1 x 4.7mm²

BATTERY MONITORING ICs

STC3115/STC3117

ST's battery fuel gauge ICs can be located in the battery pack or in the handheld device and integrate functions to monitor the battery voltage, current and temperature. Using a built-in Coulomb counter, these fuel gauge ICs calculate battery charge and store the data in 16-bit register resolution for retrieval by the system controller. Access is via an industry-standard I²C interface, enabling the controller to create an accurate graphical representation of the remaining battery-operating time. Battery-monitoring fuel gauge ICs combine a small footprint with outstanding measurement accuracy and extremely low power consumption to increase battery runtime and lifespan in mobile phones, multimedia players, digital cameras, and other space-constrained portable devices.

FEATURES

- OptimGauge™ algorithm for STC3115
- OptimGauge+™ algorithm for STC3117
- Coulomb counter and voltage gas gauge operations
- Programmable low battery alarm
- Internal temperature sensor

BENEFITS

- 3% accuracy of battery state of charge no need for shunt resistor
- Accurate estimation of battery state of charge at power-up
- Reliable battery swap detection
- SoH and impedance tracking with OptimGauge+ algorithm (ST IP)
- Charger enable and system reset control for accurate OCV reading fuel
- Minimum form factor

Part number	Charging sensing voltage range	Charging sensing resistor	Typical supply current (Icc)	Supply voltage (VDD)		Comment	Package
				Min	Max		
STC3115	±40 mV	5 to 50 mΩ	0.045 μA	2.7 V	4.5 V	OptimGauge™ algorithm	1.4 x 2.0 mm 10-bump CSP 2.0 x 3.0 mm DFN10
STC3117	±40 mV	5 to 50 mΩ	0.04 μA	2.7 V	4.5 V	Patented OptimGauge™ algorithm for accurate battery capacity calculation	1.5 x 1.6 mm 9-bump CSP

EnFilm™ THIN-FILM BATTERY

- ST's EnFilm™ thin-film batteries are a new concept of extremely thin (220 µm), rechargeable solid-state batteries with fast constant-voltage recharge and a lifetime of more than 10 years or 4000 cycles.
- They feature a LiCoO₂ cathode, LiPON ceramic electrolyte and a lithium anode, on a 25.7 x 25.7 mm footprint, so are completely safe from risks of burning or explosion.



Part number	Dimensions	Resistance(R) (Internal) (ohm)	Battery type	Battery capacity (mAh)	Operating temperature	
					min (°C)	max (°C)
EFL700A39	25.7x25.7x0.2 mm	100	Lithium	0.7	-20	60

ENERGY HARVESTING

The SPV1050 takes energy from the environment and converts it into useful electrical energy, thus making a wireless sensor node fully autonomous. The SPV1050 is an ultra-low-power energy harvester and battery charger that captures the maximum energy from a photovoltaic (PV) cell or a thermo-electric generator (TEG).



- Energy harvesting from light or thermal gradient with 90% conversion efficiency over a wide input power range
- Boost and buck-boost topologies fitting indoor and outdoor conditions
- Maximizes harvested energy with up to 60% energy gain during the charge process
- Enhanced battery longevity

Part number	General description	Input voltage (V _{in})		Operating temperature		Input duty cycle voltage		Regulated output voltage		Output Current-Max (I _{out}) (A)	Regulator switching frequency max (MHz)	Efficiency nom (%)	Disable Pin
		min (V)	max (V)	min (°C)	max (°C)	min (V)	max (V)	min (V)	max (V)				
SPV1050	Ultra low power energy harvester and battery charger with embedded MPPT and LDOs	0.18	8	-40	85	0.18	8	2.5	5.3	0.07	1	90	No

DC-DC OR POINT OF LOAD

ST's DC-DC synchronous converters are designed for consumer and portable applications. Buck, buck-boost and boost switching regulators must provide low power consumption, high-efficiency power conversion, and be available in very small packages from standard leadless plastic to flip-chip pure bumped silicon. The switching frequency control loop guarantees high dynamic response with very small inductor size. All products are optimized to work with Li-ion batteries, USB sources or the latest battery chemistries.

Feature	User benefit
Synchronous rectification and high switching frequency	PCB Miniaturization with less passive components. Chip coil inductor can be used for ST1S15
Automatic PWM and PSM mode	Maximizes efficiency over the whole load range
Low quiescent current	Extends system battery life
Programmable output voltage	One/two/three pins allow selecting the required output voltage
Automatic transition between buck and boost mode	Allows using battery over the entire operating voltage range.
Low output voltage ripple for noise sensitive systems	No secondary stage regulation is needed STBB2/STBB3
By-pass mode	Reduced power consumption for long live battery

Part number	General description	Input voltage (Vin)		Regulated output voltage		Output Current-Max (I _{OUT}) (A)	Quiescent current(Iq) typ (μA)	Switching frequency typ (KHz)	Package
		min (V)	max (V)	min (V)	max (V)				
ST1S15	500 mA, 6 MHz synchronous step-down converter	2.3	5.5	1.82	1.82	0.5	45	6000	Flip-Chip 6
STBB2	800 mA 2.5 MHz, high efficiency dual mode buck-boost DC-DC with by-pass mode	2.3	5.5	1.2	4.5	0.8	35	2500	Flip-Chip 20
STBB3J	2 A, 2 MHz, high efficiency dual mode buck-boost DC-DC converter	1.8	5.5	1.2	5.5	2	35	2000	Flip-Chip 20
STBB3JCC	2 A, high efficiency single inductor buck-boost DC-DC converter and High Brightness White LED Driver	1.8	5.5	1.2	5.5	2	35	2000	Flip-Chip 20

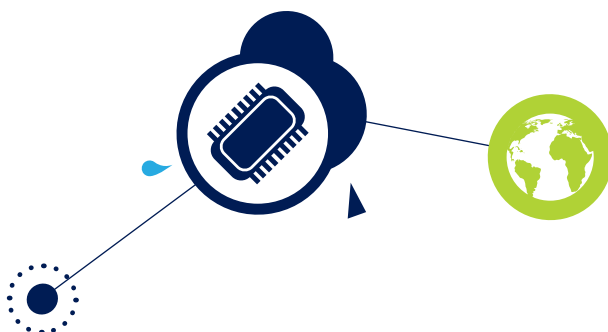

LOW-DROPOUT REGULATOR (LDO)

ST offers a complete portfolio of high-performance LDOs, with state-of-the-art figures on the key merit parameters fitting into the smallest packages available. ST's ultra-small, high-performance LDOs are particularly suitable for the latest generation of portable devices

Part number	General description	Input voltage range (V)	Output voltage (V_{OUT}) (V)	Output current (I_{OUT}) (mA)	Adjustable regulated output voltage	Supply voltage Rejection Ratio (SVR) (@ 10 kHz) typ (dB)	Dropout voltage (V_D) nom (V)	Output tolerance (%) typ	Quiescent current (I_Q) typ (μ A)	Operating temperature		Package
										min ($^{\circ}$ C)	max ($^{\circ}$ C)	
LD39020	200 mA very low quiescent current Linear regulator IC	1.5 to 5.5	0.8 : 5	200	No	67	0.2	0.5	20	-40	125	DFN4 1x1
LD39030SJ	300 mA low quiescent current soft-start, low noise voltage regulator	1.5 to 5.5	1 : 3.3	300	No	62	0.2	2	20	-40	125	Flip-Chip 4
LD39115J	150 mA low quiescent current low noise voltage regulator	1.5 to 5.5	1.2 : 3.3	150	No	67	0.09	2	20	-40	125	Flip-Chip 4
LD39130S	300 mA very low quiescent current Linear regulator IC with automatic Green mode	1.4 to 5.5	1.2 : 3.3	300	Yes	65	0.3	1	1	-40	125	Flip-Chip 4; DFN6 1.2 x 1.3
LD59015	150 mA low noise high PSRR linear voltage regulator	2.4 to 5.5	0.8 : 3.3	150	No	76	0.15	1.8	31	-40	125	SOT323-5L
LD59030*	300 mA very low quiescent current Linear regulator IC	1.5 to 5.5	0.8 : 5	300	No	67	0.135	1	20	-40	125	DFN4 1x1
LDBL20	200 mA very low quiescent current Linear regulator IC	1.5 to 5.5	0.8 : 5	200	No	67	0.2	0.5	20	-40	125	ST STAMP™
LDK120	200 mA low quiescent current very low noise LDO	1.9 to 5.5	0.8 : 3.5	200	Yes	36	0.1	2	30	-40	125	SOT23-5L; SOT323-5L; DFN6 1.2x1.3
LDK130	300 mA low quiescent current very low noise LDO	1.9 to 5.5	0.8 : 3.3	300	Yes	35	0.2	2	30	-40	125	SOT23-5L; SOT323-5L; DFN6 1.2x1.3
LDLN025	250 mA - ultra low noise - high PSRR linear voltage regulator IC	1.5 to 5.5	1 : 5	250	No	70	0.12	1	12	-40	125	Flip-Chip 4; DFN4 1x1
STLQ020	200 mA - ultra low quiescent current linear voltage regulator	2 to 5.5	0.8 : 4.5	200	Yes	50	0.16	2	0.3	-40	125	Flip-Chip 4; SOT323-5L; DFN6 2x2
STLQ50	50 mA, 3 μ A Supply current low drop linear regulator	2.3 to 12	1.8 : 5	50	Yes	20	0.2	2	3	-40	125	SOT323-5L

Note: * in development

ST STAMP™: A STEP FURTHER IN MINIATURIZATION

ST STAMP™ (ST Small Thickness Advanced Micro Package) is ST's trademark for our new unique and innovative bumpless CSP package.

Compared to the smallest DFN plastic packages and flip-chips, the ST STAMP™ solution provides similar package performance and reliability, reducing the total height to 200 μ m or less, with a smaller footprint.

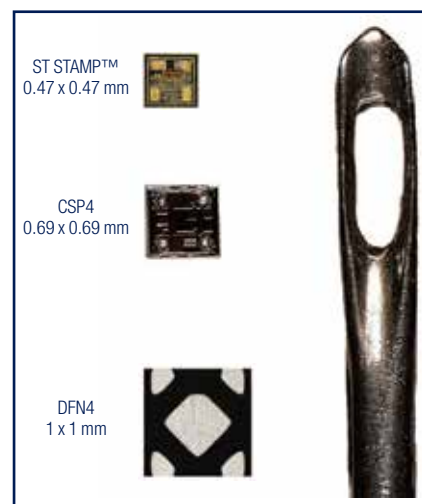

SMART RESET

ST's smart reset ICs extend the functional capacity of existing control buttons to give users the possibility of resetting a device, with a single or two simultaneous buttons.



KEY FEATURES

- Choice of a single button or two simultaneous buttons to signal a reset
- Support for applications where the battery cannot be removed
- Tiny packages

Part number	Number of reset button	Number of power button	Reset setup delay typ (sec)	Reset pulse duration (ms). Typ.	Supply voltage (V)	Package
SR1	1	-	(1.5-10)	Push button controlled or factory programmed time	2 to 5.5	DFN6 (1x1.45x0.55)
SR2	2	-	(4-10)	Push button controlled or factory programmed time	1.65 to 5.5	DFN6 (1x1.3x0.55)
SRC0	1	1	Selectable via ext. capacitor	360	1.6 to 5.5	DFN12 (2x3x0.75)





User interface

AUDIO AMPLIFIERS

ST's wide audio IC portfolio includes low-power headphone and power amplifiers specifically designed for wearable devices.



KEY FEATURES

- High efficiency
- Battery-operated features
- Tiny packages
- High audio quality

34

Part number	Description	Channels	Output power (W)	Supply voltage (V)	SNR @ 1 kHz (dB)	Stby current (μ A) Typ	Package (mm)
A21SP16	3 W filter-free class D audio power amplifier with standb	1	3 W into 4 Ω 1.75 W into 8 Ω	2.4 to 5.5	85 for 8 Ω	<1	Flip-chip 9 x 500 u (1.60 x 1.60 x 0.6)
A22H165	High-performance class-G headphone amplifier	2	57 mW @ 16 Ω 38 mW @ 47 Ω	2.3 to 4.8	100 min	0.6	Flip-chip 16 x 400 u (1.65 x 1.65 x 0.6)
A22H165M	High-performance class-G headphone amplifier with I ² C volume control	2	57 mW @ 16 Ω 38 mW @ 47 Ω	2.3 to 4.8	100 min	0.6	Flip-chip 16 x 400 u (1.65 x 1.65 x 0.6)

LED / OLED

ST provides monolithic OLED power management devices that add value to new designs by simplifying power-supply circuitry and also maximizing battery life for feature-rich portable products. Yet, ST's intelligent LED drivers provide the necessary voltage to power multiple LEDs that can be arranged in different configurations.

AMOLED Power Supply

- World's best product portfolio
- Outstanding electrical performance
 - 90% efficiency in worst case
 - TDMA noise control to minimize display flickering

LCD backlight

- Series and parallel LED configuration powered by linear or switching architectures
- Superior brightness control
 - 1% current matching
 - High resolution PWM dimming
- Full LED diagnostics for service and production

Matrix LED drivers

- High level of integration with embedded power rail
 - Adaptive power rail to maximize efficiency
- Analog and digital PWM dimming for optimum color calibration
- LED failure detection

OLED

Part number	General description	Input voltage (Vcc) min (V)	Output voltage (Vout) (positive)		Output voltage variation (positive) typ (%)	Quiescent current (Iq) typ (mA)	Switching frequency typ (MHz)	Topology	Efficiency max (%)	Package
			min (V)	max (V)						
STOD1317B	170 mA 13 V, high efficiency boost converter + LDO	2.6	6	13	-1.0, +1.0	1	1.2	Boost cascaded with an LDO	85	DFN12
STOD32W	100 mA triple DC-DC converter for powering AMOLED displays	2.9	4.577	4.623	-0.5, +0.5	-	1.55	Boost + Inverting	92	Flip-Chip 12

LED DRIVERS

Part number	General description	Input voltage (Vcc)		Output current-Max (I _{out}) nom (mA)	Output current accuracy typ (%)	Number of LEDs max ()	Switching frequency typ (MHz)	LED configuration	Package
		min (V)	max (V)						
STLED524	Intelligent matrix LED display driver	2.7	5.5	480	7.5	5x24	2.4	Matrix	GSP 56 3.4 x 3.0 mm, pitch 0.4 mm
STP4CMP	Low voltage 4-channel constant current LED driver with charge pump	2.7	5.5	120	7	4	-	Parallel	QFPN 20 3.2 x 1.8

FingerTip TOUCHSCREEN CONTROLLERS

ST's FingerTip® family of touch controllers provides true multi-touch capability, supporting unlimited simultaneous touches. These devices represent a marked improvement by providing an optimal mix of low power, small size and highly-precise multiple finger tracking in a single chip.



KEY FEATURES

- Small touch screen size with round or square form factor
- Support all types of Touch ITO
- Support multi-finger, thick glove, wet fingers and 1 mm passive pen
- Ultra-low power for longer battery life
- Noise immunity to all sources
- High SNR
- Scan rate >150 Hz
- GPIO for button support
- I²C interface
- Small and thin QFN 4x4x0.4 mm

The latest FingerTip series is available for selected customers for high volume. For more information, contact your ST sales office.

REAL-TIME CLOCK

ST's M41T62LC6F real-time clock is the perfect match for wearable devices when size, weight, and power-efficiency matters. It offers a very low frequency error at 25 °C which equates to about 5 seconds per month, an ultra-low power consumption of 350 nA in stand-by, and comes in an ultra-small 1.5 x 3.2 mm package with an embedded crystal oscillator.



BENEFITS

- Ultra-small package with embedded crystal 1.5 x 3.2 x 0.8mm
- Ultra-low power consumption 350nA
- Timekeeping voltage down to 1 V
- Programmable alarms with wake-up functions
- +/- 2PPM accuracy by digital calibration
- Compatible with Li-Ion battery voltages

Part number	General description	Package	Battery supply current (nA typ.)	Data Bus type	Supply Voltage min-max (V)
M41T62	Ultra low-power serial real-time clock	LCC8 (3.2 x 1.5mm)	350	I ² C	1.3-4.4



Serial EEPROM



STMicroelectronics serial EEPROMs offer the most complete range of products to fit various space constraints aspects. Leadless packages such as DFN8 and DFN5 allow to minimize the PCB footprint while still having a robust plastic housing. Wafer Level Chip Scale Packages (WLCSP) offer the smallest and thinnest footprint. With I²C interface pin count can be reduced to 4 balls and size of less than 1mm² allows to place the EEPROM in any tiny space left on the PCB. In addition WLCSP products are also available in various thickness from 0.6mm down to 0.3mm for ultrathin modules.

STMicroelectronics offers a complete range of Serial EEPROM densities and packages which brings flexibility in design, enable reliable parameter management while being almost invisible in the global PCB footprint.

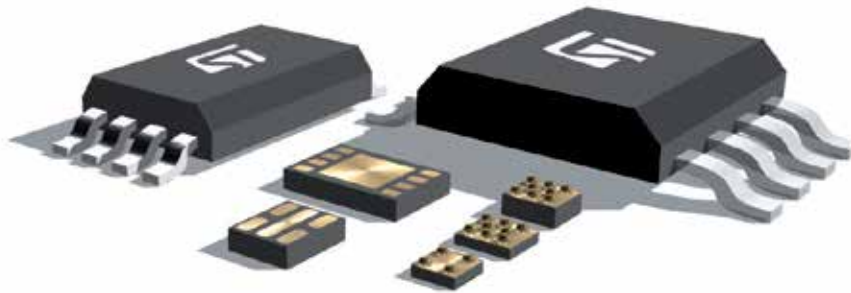

		1 Kb	2 Kb	4 Kb	8 Kb	16 Kb	32 Kb	64 Kb	128 K	256 K	512 K	1 Mb	2 Mb
I ² C	DFN8		•	•	•	•	•	•	•	•	•		
	DFN5		•	•	•	•	•	•	•				
	WLCSP 8 balls							•	•	•	•	•	
	WLCSP Ultrathin 4 balls				•	•	•	•	•				•
SPI	DFN8		•	•	•	•	•	•	•	•	•		
	WLCSP 8 balls							•	•	•	•	•	•

KEY FEATURES

- Fit
 - Complete range 2 Kbit to 2 Mbit
 - Standard interface I²C, SPI
- Function
 - Low power operation versus Flash
 - Low voltage operation 1.6 V min
 - 4Million cycles per byte at 25 °C
- Hardware
 - Ultra small WLCSP 4 pins < 1 mm²
 - Ultra Thin WLCSP < 0.33 mm
 - Ultra Light WLCSP < 1 mg
 - Robust leadless package: DFN8, DFN5

BENEFITS

- Fit
 - Flexibility in design and memory size upgrades
- Function
 - Longer battery life time
 - Efficient for datalog and frequent updates
- Hardware
 - Almost invisible PCB footprint
 - Fits ultrathin modules
 - Suitable for light weight modules





ESD protection

ESD PROTECTION DEVICES

Wearable devices are by nature vulnerable to ESD. Indeed, they are small integrated devices using ESD-sensitive ICs with thin lithography technologies and in close contact with electrostatic charges that a human can develop in low relative humidity. The risk of ESD damage is then very high.

Benefits of ST's current ESD protection devices:

- High efficiency of protection with low clamping voltages down 7 V with Snapback « Z » series.
- Transparency to high-speed signals with ultra-wide bandwidth up to 20 GHz
- Flexibility and Integration with single- or multi-line products from 01005 package size
- High robustness against surges with capability up to 30 kV
- High Ipp versions to combine EOS and ESD in smallest packages

Part number	Number of lines	Directionality	Breakdown voltage (in volt)	Capacitance line to GND (C _{line} in pF)	Clamping voltage max (V _{CL} @30ns)	IEC 61000-4-2 min (contact for 8 kV in V)	Package & size (mm x mm)
General purpose ESD protection							
ESDA5-1BF4	1	Bi-Directional	5.8	45	11	8	ST0201 0.6x0.3
ESDZV5-1BF4	1	Bi-Directional	5.8	5	7	18	ST0201 0.6x0.3
ESDZV18-1BF4	1	Bi-Directional	18	3	21.5	30	ST0201 0.6x0.3
ESDZV5-1BV2	1	Bi-Directional	5.8	5	7	16	ST01005 0.2x0.45
ESDAVLC12-1BV2	1	Bi-Directional	12	7	30	15	ST01005 0.2x0.45
ESDAVLC5-4BU4	4	Bi-Directional	5.5	6	15	15	uQFN-4L 0.9x0.5
High-speed signals ESD protection							
ESDAULC5-1BF4	1	Bi-Directional	4.8	1.5	11	30	ST0201 0.6x0.3
ESDARF02-1BU2CK	1	Bi-Directional	5	0.25	19	8	ST0201 0.6x0.3
HSP051-4N10	4	Uni-Directional	4.5	0.4	13	8	uQFN-10L 1.9x1.0
HSP053-4M5	4	Uni-Directional	5.8	0.25	15	10	uQFN-10L 1.3x0.8
USBULC6-2N4	2	Uni-Directional	6	0.6	17	12	uQFN-4L 1.0x0.8
USB Vbus and Vbat ESD & EOS protection							
Part number	Number of lines	Directionality	Voltage	Peak pulse current (I _{pp} @8/20µs)	Vcl @ I _{pp} (@8/20µs surge)	IEC 61000-4-2 min (contact for 8 kV in V)	Package & size (mm x mm)
ESDA7P60-1U1M	1	Uni-Directional	5.5	80	8	30	ST1608 1.6x0.8
ESDA7P120-1U1M	1	Uni-Directional	5.5	120	11	30	ST1608 1.6x0.8
ESDA13P70-1U1M	1	Uni-Directional	12	70	20	30	ST1608 1.6x0.8
ESDA15P60-1U1M	1	Uni-Directional	13.2	60	20	30	ST1608 1.6x0.8
ESDA17P50-1U1M	1	Uni-Directional	15	50	24	30	ST1608 1.6x0.8
ESDA25P35-1U1M	1	Uni-Directional	22	35	39	30	ST1608 1.6x0.8
ESDALC20-1BF4	1	Bi-Directional	20	2.4	37	20	ST0201 0.6x0.3



EMI filtering

EMI AND COMMON-MODE FILTERS

Wearable devices are sensitive to electro-magnetic interference. They are small integrated devices with a high density of components mounted on PCB. The risk of antenna desense and EMI coupling must be mitigated.

ST offers a wide range of EMI and common-mode filters (ECMF™) with the following benefits:

- Drastically reduce radiated noise and antenna de-sense with unique extra large rejection band or extra deep rejection at selected frequencies
- High integration: 1mm² for 2 differential lines for ECMF™
- High quality of protection with low clamping voltages

EMI FILTERS

Part number	Target interface	Number of lines	Number of integrated discrete components	Clamping voltage max (V _{CL} @30ns in V)	IEC 61000-4-2 min (contact discharge) in kV)	Package	Package size (mm x mm)
EMIF02-SPK03F2	Speaker	2	10	16.7 V for 30 kV contact surge	30	WLCSP	0.89 x 1.26
EMIF04-EAR02M8	Audio jack	4	20	9.2 V for 8 kV contact surge	30	uQFN-8L	1.5 x 1.7
EMIF06-USD04F3	Micro-SD card	6	24	24.9 V for 8 kV contact surge	8	WLCSP	1.54 x 1.54
EMIF08-VID1F3	Keypad, camera, LCD	8	40	4.5 V for 8 kV contact surge	20	WLCSP	1.04 x 3.15

38

COMMON-MODE FILTERS

Part number	Number of lines	Attenuation @ Frequency	Bandwidth (@-3dB) in MHz	Clamping voltage max (V _{CL} @30ns in V)	IEC 61000-4-2 min (contact discharge) in kV)	Package	Package size (mm x mm)
ECMF02-2HSMX6	2	-20 dB @ 2400 MHz	3200	26.8	8	uQFN-6L	1.35 x 1.60
ECMF02-2BF3	3	-30 dB @ 900 MHz	5000	30	10	WLCSP	1.35 x 0.83
ECMF4-20A42N10	4	-13 dB at 0.7 GHz -15 dB at 1.5 GHz -25 dB at 2.4 GHz -23 dB at 2.7 GHz -13 dB at 5.0 GHz	5000	11	8	uQFN-10L	1.35 x 2.2
ECMF4-2450A60N10	4	-15 dB at 1.5 GHz -26 dB at 2.4 GHz -23 dB at 5.0 GHz	6000	11	10	uQFN-10L	1.35 x 2.2
CMF2-0650A09H3	2	-20 dB from 600 MHz to 5 GHz	900	N/A	N/A	WLCSP	1.2 x 0.74



Design support

ST has a wide product portfolio for Wearable applications and provides solution to solve the most complex design challenge:

- Single Product Evaluation Boards
- Fast prototyping and Development Boards
- Solution Evaluation Boards
- Software Development Tools

PRODUCT EVALUATION BOARDS

ST proposes a wide range of evaluation boards that may be used to perform a comprehensive evaluation of ST's products reducing your development time. These evaluation boards help you evaluate the features and performance of selected products, all of them have published online fully tested schematics, BOMs and Gerber files to facilitate your hardware design. Many, where appropriate, also have demonstration software packages available as well.

STM32 OPEN DEVELOPMENT ENVIRONMENT

The STM32 Open Development Environment is a fast and affordable way to prototype and develop innovative applications with state-of-art ST components based on the STM32 32-bit microcontroller family and a comprehensive set of functions for sensing, connectivity, power, audio, motor control and more. The combination of a broad range of expandable hardware based on leading-edge commercial products and modular software, from driver to application level, enables fast prototyping of ideas that can be smoothly transformed into final designs.



STM32 Open Development Environment

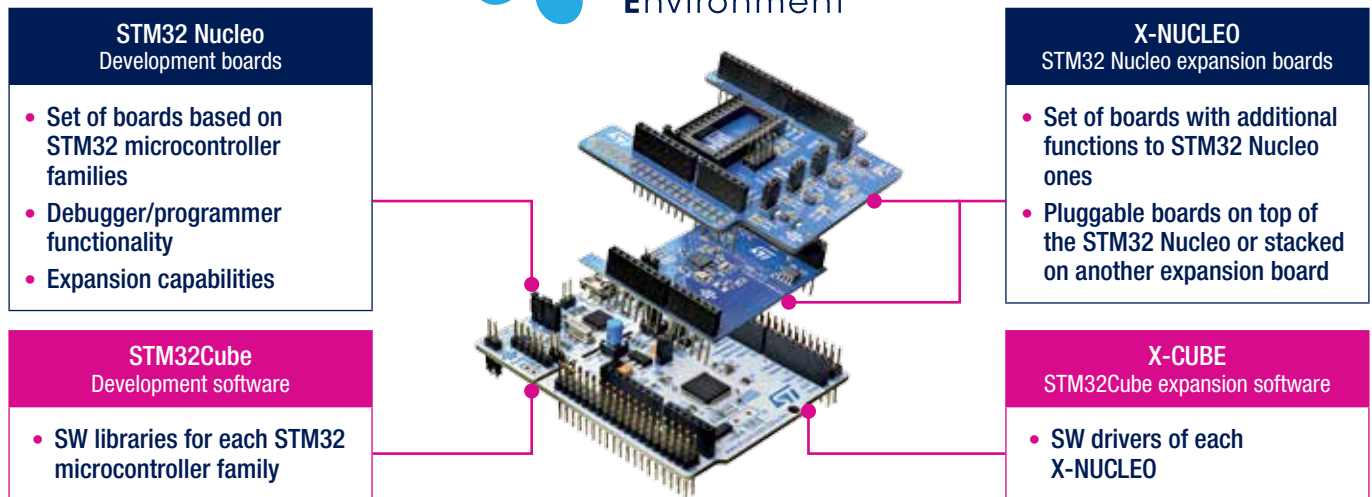

The STM32 Open Development Environment is compatible with a number of IDEs including IAR EWARM, Keil MDK-ARM, ARM® mbed™ and GCC-based environments.

A COMPLETE HARDWARE OFFER

37 expansion boards covering all the key functions



Sense

Motion & environmental sensors
Proximity sensor
Microphone



Connect

BLE
Wi-Fi
Sub-GHz
NFC



Power Drive

Power management
LED Boost



Move Actuate

Motor drive
Actuator



Translate

Audio
OpAmp

16 processor boards



WEARABLE SOLUTION EVALUATION BOARD

ST is offering also a reference platform for easy development of wearable applications, thanks to its design: compact solution, ultra-low power hardware and firmware features, a complete set of firmware example and turnkey software on host device (i.e. an Smartphone or Tablet).

Wearable Sensor Unit

STEVAL-WESU1



KEY FEATURES

- Compact solution for wearable, motion sensing applications with a complete set of firmware examples
- iOS and Android apps available
- 100 mAh Li-Ion battery included, UN38.3 tested and certified
- Micro USB connector for recharging
- SWD programming cable and JTAG adapter
- Watch strap with plastic housing included
- Fully tested and certified by FCC, IC, Japan Radio

SensorTile development kit

STEVAL-STLKT01V1



KEY FEATURES

- 13x13 mm solderable module (STEVAL-STLCS01V1) and connectable module (STEVAL-STLCS02V1)
- SensorTile expansion Cradle board equipped with audio DAC, USB port and STM32 Nucleo connector
- SensorTile Cradle with battery charger, humidity and temperature sensor, SD memory card slot and USB port
- 100 mAh Li-Ion battery, UN38.3 tested and certified
- SWD programming cable
- Fully tested and certified by FCC, IC, Japan Radio

BlueCoin Development Kit

STEVAL-BCNKT01V1



KEY FEATURES

- BlueCoin module with STM32, Motion Sensors, Microphones and Bluetooth Low Energy Connectivity
- Coin Station board equipped with Time-of-Flight sensor and Power Management stage
- BlueCoin Cradle with SD memory card slot, USB port and battery connector
- 130 mAh Li-Po battery, UN38.3 tested and certified
- Fully tested and certified by FCC, IC

SOFTWARE DEVELOPMENT TOOLS

ST provides software to accelerate evaluation and development of its main products. Libraries, snippets, middleware, codecs and protocol stacks, sample applications provided in Firmware packages to assist in the development process by permitting software development with a certain level of abstraction from the register level of the hardware.

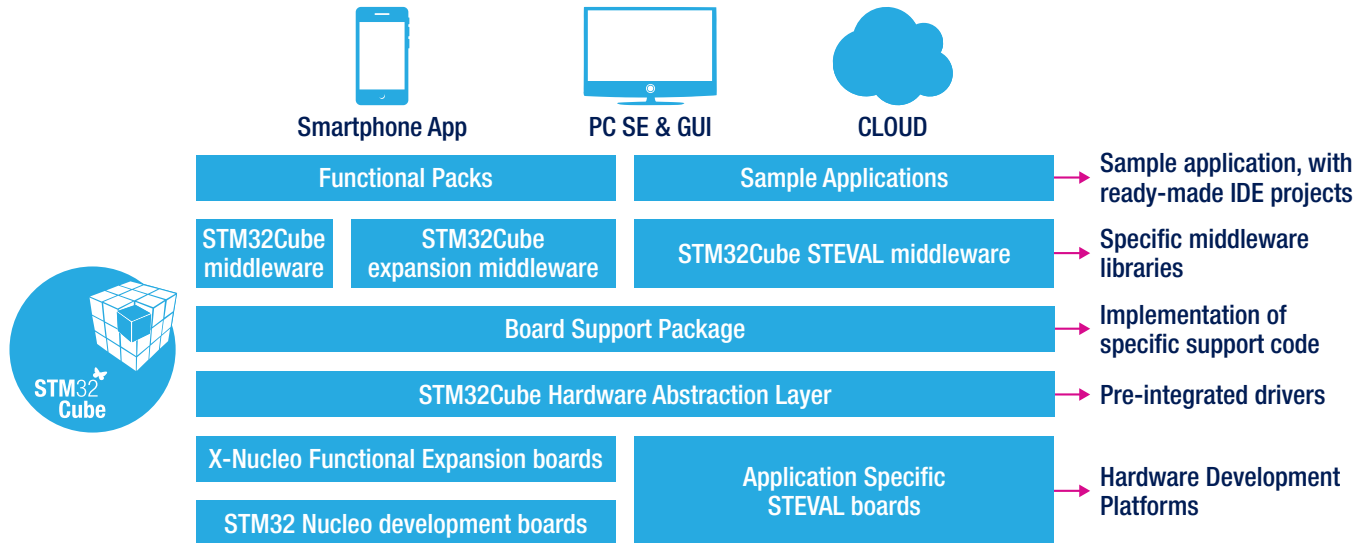

STM32 ODE FUNCTION PACKS

STM32 Function Packs are a combination of low-level drivers, middleware libraries and sample applications assembled into a single software package. Used together with the suggested combination of STM32 Nucleo development boards and X-NUCLEO expansion boards, Function Packs help jump-start the implementation and the development of a number of “functions” in different domains: Cloud connectivity, Networking, Security and Sensing.

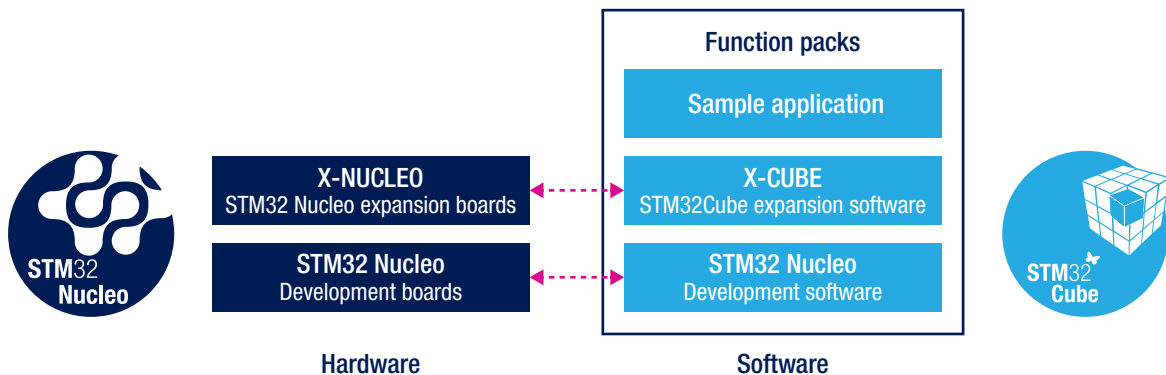

SMARTPHONE APPS AND SDKS

Several Apps are available to evaluate quickly ST Solutions, multi-platform Software Development Kit for Android and iOS. Easy development thanks to the source code availability and application examples available for quick startup.



Board Data collecting and configuration services



Over the Air Firmware Upgrade

CLOUD PARTNERS PROGRAM

ST offer a Cloud Partners Program* permitting users to focus on wireless node added values. Available for developers there are Cloud Access Functions Packs providing reference implementations for connecting STM320DE developer systems directly with cloud service providers without the need for developers to write specific code.

Visit www.st.com for further details.

Note: * Cloud platform development available according to partners standard schemes.



life.augmented



© STMicroelectronics - June 2017 - Printed in United Kingdom - All rights reserved
The STMicroelectronics corporate logo is a registered trademark of the STMicroelectronics group of companies
All other names are the property of their respective owners

