

RED LED

▲ CIRCUIT: SPST
OFF (ON)

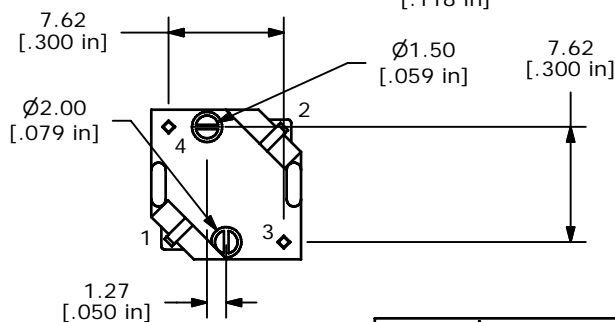
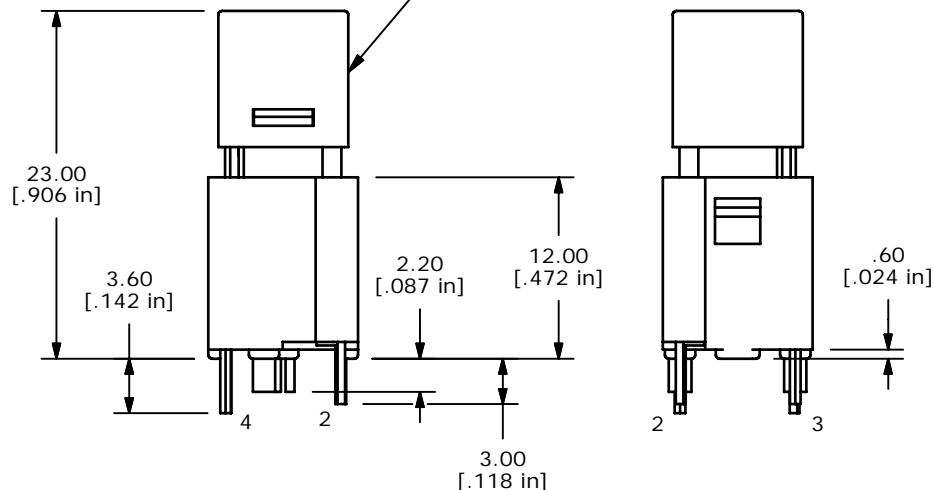
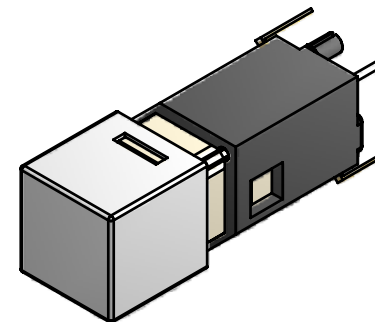
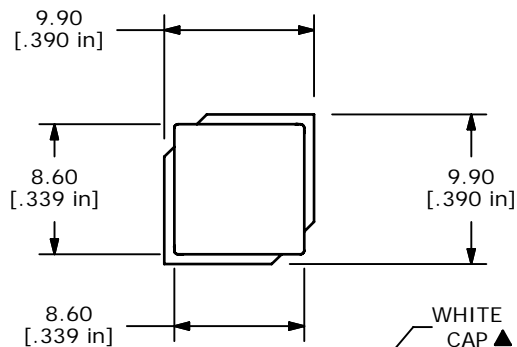
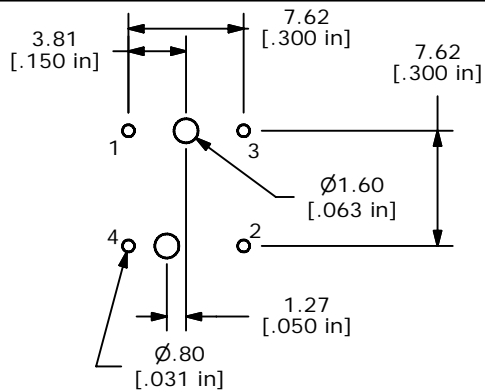

NOTES:

1. ALL DIMENSIONS IN MM [INCH]
2. GENERAL TOLERANCE: X.X=±0.4
X.XX=±0.25
3. RATING: 20VDC @ 1mA or 5VDC @ 5mA
4. CONTACT RESISTANCE: 200Ω MAX. @ 5VDC, 1mA
5. INSULATION RESISTANCE: 100MΩ MIN. @ 100VDC.
- ▲ 6. OPERATING FORCE: 125± 35gf
7. TRAVEL: 1.3 +/-0.3 mm
8. OPERATING TEMPERATURE: -20°C TO 70°C
9. OPERATING LIFE: 300,000 CYCLES
- ▲ 10. LED: RED
11. ▲ DENOTES CRITICAL PARAMETERS
12. 2002/95/EC (ROHS) COMPLIANT

▲ LED SPECS		UNITS	RED
FORWARD CURRENT		mA	20 NOMINAL
FORWARD VOLTAGE @20mA		V	1.50 TYP. 2.40 MAX.
LUMINOUS INTENSITY @ 20mA		mcd	120 TYP.



TITLE LP2S2WHTRED-N

A	18647	NEW RELEASE	9/14/09	RC
REV	PCR NO	DESCRIPTION	DATE	BY

SCALE	DATE	DR	DWG	REV
2=1	8/25/2009	RC	B250003	A

THE INFORMATION CONTAINED IN THIS DOCUMENT IS PROPRIETARY TO E-SWITCH AND IS NOT TO BE COPIED OR TRANSFERRED