

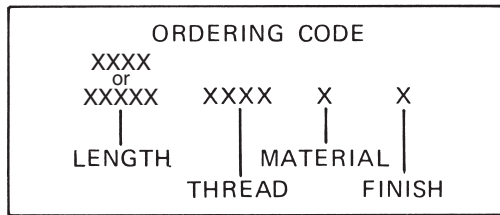

1/4 ROUND FEMALE STANDOFFS

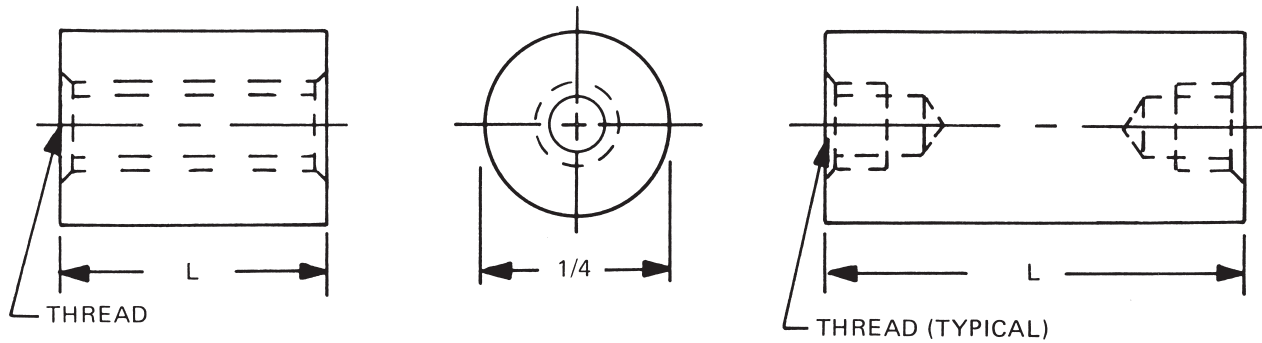

See page 10 for thread depth chart
 See page 9 for finish codes
 For non-standard parts contact Sales Office

LENGTH	PART NO.
3/32	1678A
1/8	1678
5/32	1678T
3/16	1679
7/32	1679T
1/4	1680
9/32	1680T
5/16	1681
11/32	1681T
3/8	1682
13/32	1682T
7/16	1683
15/32	1683T
1/2	1684
17/32	1684T
9/16	1685
19/32	1685T
5/8	1686
21/32	1686T
11/16	1687
23/32	1687T
3/4	1688
25/32	1688T
13/16	1689
27/32	1689T
7/8	1690
29/32	1690T

LENGTH	PART NO.
15/16	1691
31/32	1691T
1"	1692
1-1/16	1693
1-1/8	1694
1-3/16	1695
1-1/4	1696
1-5/16	1697
1-3/8	1698
1-7/16	1699
1-1/2	1700
1-9/16	1701
1-5/8	1702
1-11/16	1703
1-3/4	1704
1-13/16	1705
1-7/8	1706
1-15/16	1707
2"	1708
2-1/8	1709
2-1/4	1710
2-3/8	1711
2-1/2	1712
2-5/8	1713
2-3/4	1714
2-7/8	1715
3"	1716

LENGTH	PART NO.
3-1/4	1717
3-1/2	1718
3-3/4	1719
4"	1720
4-1/4	1721
4-1/2	1722
4-3/4	1723
5"	1724
5-1/4	1725
5-1/2	1726
5-3/4	1727
6"	1728
6-1/4	1729
6-1/2	1730
6-3/4	1731
7"	1732
7-1/4	1733
7-1/2	1734
7-3/4	1735
8"	1736
8-1/4	1737
8-1/2	1738
8-3/4	1739
9"	1740
9-1/4	1741
9-1/2	1742
9-3/4	1743
10"	1744

THREAD	CODE
4-40	440
6-32	632
8-32	832
10-32	1032

MATERIAL	CODE	RoHS
Aluminum	AL	YES
Brass	B	YES
Stainless Steel	SS	YES
Steel	S	YES
Nylon	N	YES
Phenolic	PH	YES



RAF ELECTRONIC
HARDWARE

95 Silvermine Road, Seymour, Ct. 06483 Phone: 203-888-2133 Fax: 203-888-9860
 e-mail: info@rafhdwe.com Web: www.rafhdwe.com

