

# RECTIFIERS

## High Efficiency, 5A

UES1304  
UES1305  
UES1306

### FEATURES

- Very Low Forward Voltage (1.15V)
- Very Fast Recovery Times (50nSec)
- Small Size
- High Surge

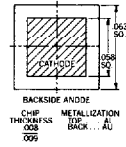

### DESCRIPTION

The UES1304 series is specifically designed for operation in power switching circuits operating at frequencies of at least 20 KHz.

### ABSOLUTE MAXIMUM RATINGS

Peak Inverse Voltage, UES1304	.....	.200V
Peak Inverse Voltage, UES1305	.....	.300V
Peak Inverse Voltage, UES1306	.....	.400V
Maximum Average DC Output Current, $I_O$		
@ $T_A = 25^\circ\text{C}$ (Free Air)	.....	3A
@ $T_L = 50^\circ\text{C}$ , $L = \frac{3}{8}"$	.....	5A
Surge Current, 8.3mSec	.....	.70A
Thermal Resistance @ $L = \frac{3}{8}"$	.....	20°C/W
Operating and Storage Temperature Range	.....	-55°C to +150°C

### MECHANICAL SPECIFICATIONS

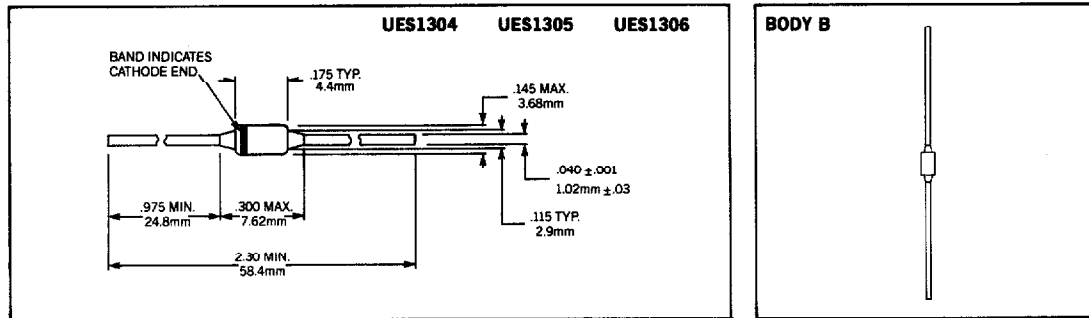

THESE DEVICES ALSO AVAILABLE IN SURFACE MOUNT PACKAGE. SEE SECTION 10

**Microsemi Corp.**  
**Watertown**  
*The diode experts*

**ELECTRICAL SPECIFICATIONS**

Type	PIV	Maximum Forward Voltage		Maximum Reverse Current		Maximum Reverse Recovery Time*
		$T_J = 25^\circ\text{C}$	$T_J = 100^\circ\text{C}$	@ PIV, $T_J = 25^\circ\text{C}$	$T_J = 100^\circ\text{C}$	
UES1304	200V	1.25V	1.15V	$20\mu\text{A}$	$500\mu\text{A}$	50nS
UES1305	300V	@ 3A	@ 3A			
UES1306	400V	$t_p = 300\mu\text{S}$	$t_p = 300\mu\text{S}$			

\* Measured in circuit  $I_F = 0.5\text{A}$ ,  $I_R = 1\text{A}$ ,  $I_{REC} = 0.25\text{A}$

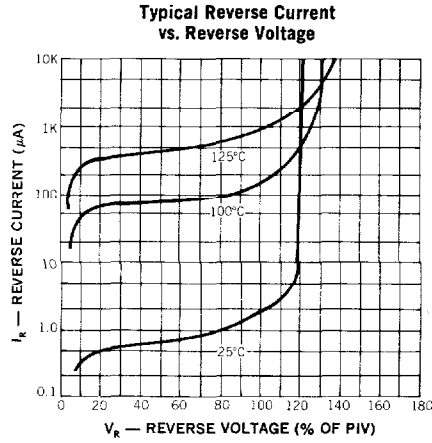
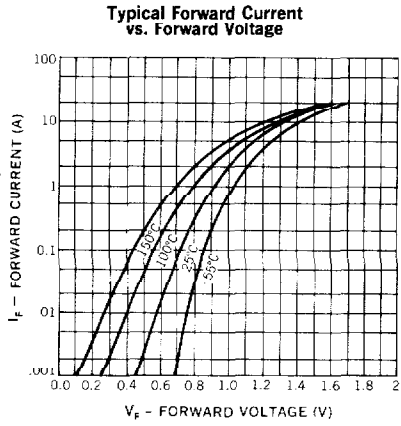
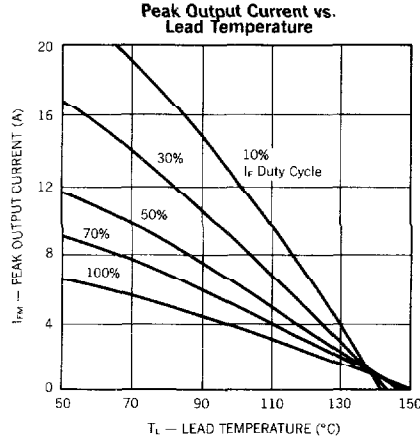
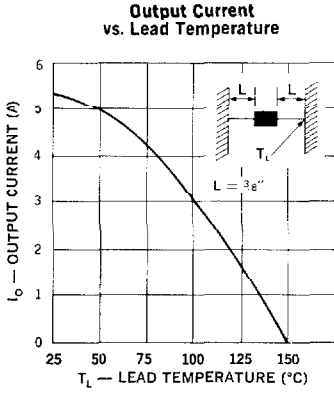

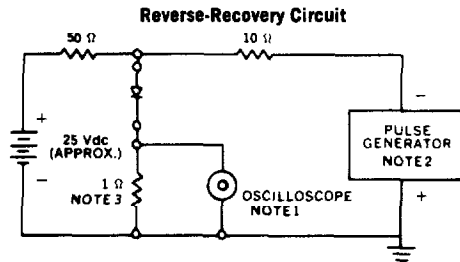
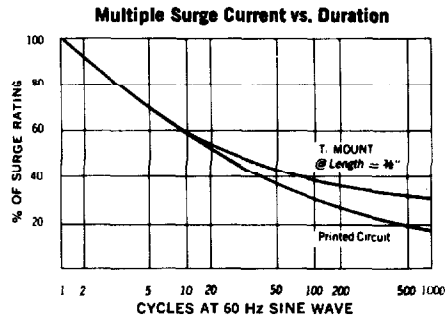
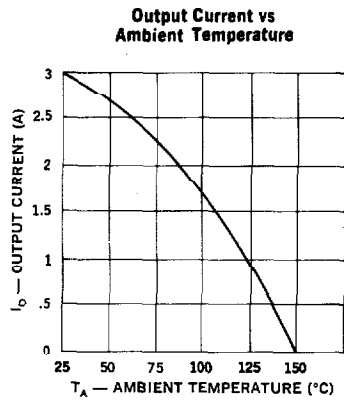

- NOTES:**
1. Oscilloscope: Rise time  $\leq 3$ ns; Input impedance =  $\infty \Omega$ .
  2. Pulse Generator: Rise time  $\leq 8$ ns; source impedance 10 $\Omega$ .
  3. Current viewing resistor, non-inductive, coaxial recommended.