

*RoHS COMPLIANT

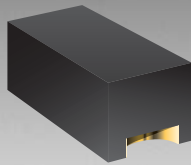

BOURNS®

Features

- RoHS compliant*
- Low forward voltage
- Extremely thin/leadless package
- Majority carrier conduction
- Designed for mounting on small surface



This series is currently available but not recommended for new designs.

CD1005-B0520 – Surface Mount Schottky Barrier Diode

General Information

The markets of portable communications, computing and video equipment are challenging the semiconductor industry to develop increasingly smaller electronic components. Bourns offers Schottky Barrier Diodes for these applications, in compact chip package 1005 (SOD323) size format, which offer PCB real estate savings and are considerably smaller than most competitive parts. The Schottky Barrier Diodes offer a forward current of 0.5 A with a repetitive peak reverse voltage of 30 V.

Bourns® Chip Diodes conform to JEDEC standards, are easy to handle on standard pick and place equipment and their flat configuration minimizes roll away.

Electrical Characteristics (@ $T_A = 25\text{ }^\circ\text{C}$ Unless Otherwise Noted)

Parameter	Symbol	Min.	Nom.	Max.	Unit
Repetitive Peak Reverse Voltage	V_{RRM}			30	V
Reverse Voltage	V_R			20	V
Average Forward Rectified Current	I_O			0.5	A
Maximum Instantaneous Forward Voltage @ $I_F = 1.0\text{ A}$	V_F		0.45	0.55	V
Peak forward surge current 8.3 ms single half sine-wave superimposed on rated load (JEDEC Method)	I_{FSM}			2	A
Forward Voltage ($I_F = 100\text{ mA}$)	V_F		0.25	0.36	V
Forward Voltage ($I_F = 500\text{ mA}$)	V_F		0.35	0.47	V
Reverse Current ($V_R = 20\text{ V}$)	I_R			100	μA
Capacitance between terminals ($f = 1\text{ MHz}$, and 0 VDC reverse voltage)	C_T		100		pF

Thermal Characteristics (@ $T_A = 25\text{ }^\circ\text{C}$ Unless Otherwise Noted)

Parameter	Symbol	CD1005-B0520	Unit
Junction Temperature Range	T_J	-40 to +125	$^\circ\text{C}$
Storage Temperature Range	T_{STG}	-40 to +125	$^\circ\text{C}$

*RoHS Directive 2002/95/EC Jan 27, 2003 including Annex.
Specifications are subject to change without notice.
Customers should verify actual device performance in their specific applications.

CD1005-B0520 – Surface Mount Schottky Barrier Diode



Product Dimensions

This is an RoHS compliant product. It is a SOD-323F (1005) standard package, molded plastic. The terminals are Gold plated and are solderable per MIL-STD-750, Method 2026. The polarity is indicated by a cathode band. The package weighs approximately 0.006 g. The package and dimensions are shown below.

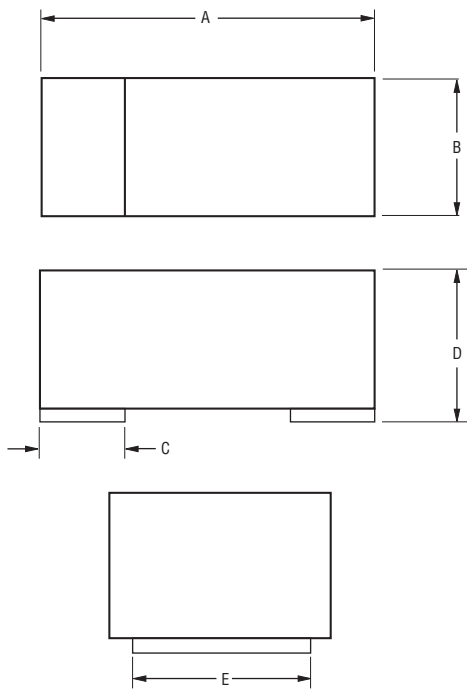

Dimension	1005
A	$\frac{2.40 - 2.60}{(0.095 - 0.102)}$
B	$\frac{1.10 - 1.30}{(0.043 - 0.051)}$
C	$\frac{0.50}{(0.020)}$ Typ.
D	$\frac{0.70 - 0.90}{(0.027 - 0.035)}$
E	$\frac{1.00}{(0.039)}$ Typ.

Recommended Pad Layout

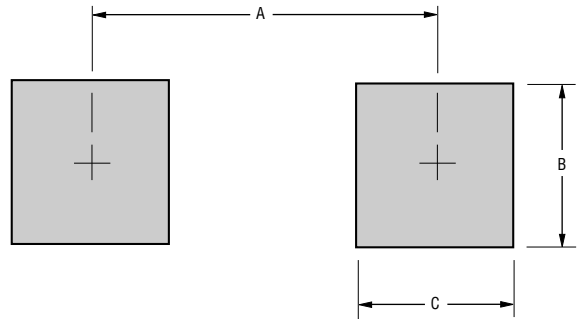

Dimension	1005
A (Max.)	$\frac{2.10}{(0.082)}$
B (Min.)	$\frac{1.20}{(0.047)}$
C (Min.)	$\frac{1.20}{(0.047)}$

DIMENSIONS: $\frac{\text{MM}}{(\text{INCHES})}$

How To Order

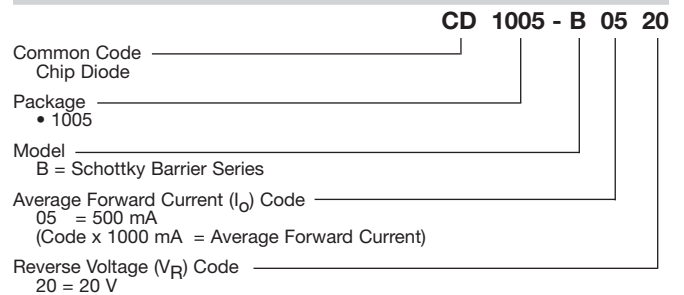

CD1005-B0520 – Surface Mount Schottky Barrier Diode



Rating and Characteristic Curves

Typical Capacitance

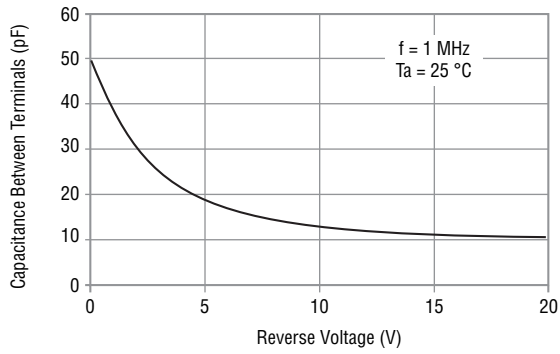

Current Derating Curve

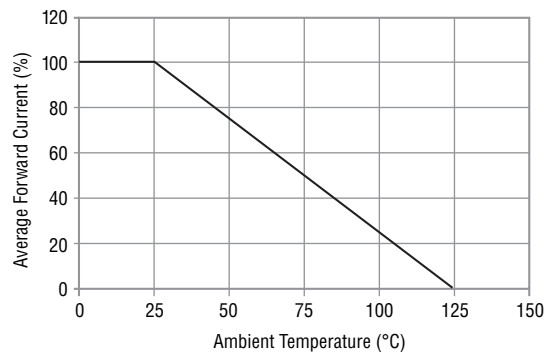

Forward Characteristics

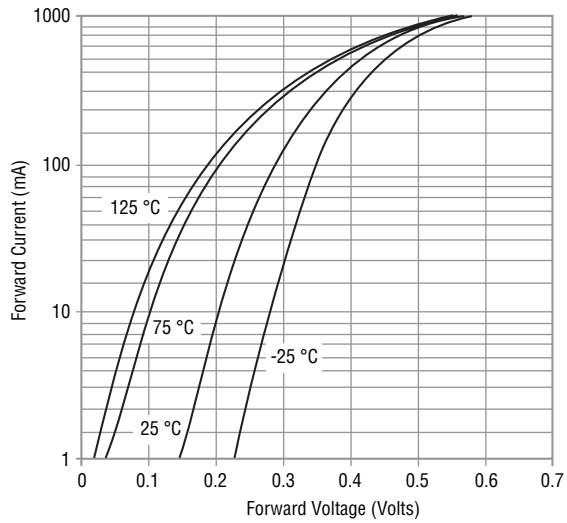

Reverse Characteristics

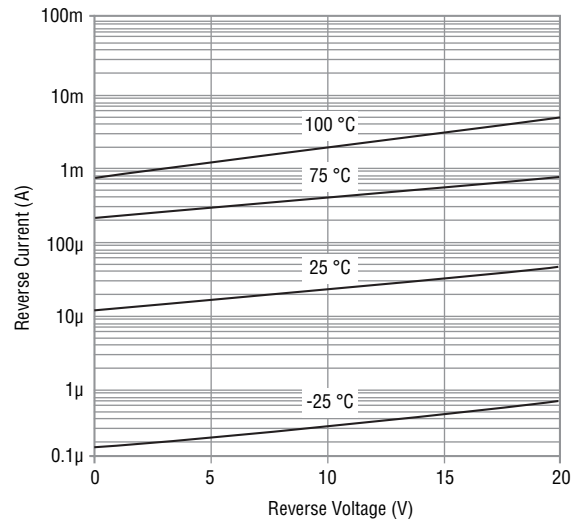

CD1005-B0520 – Surface Mount Schottky Barrier Diode



Packaging Information

The surface mount product is packaged in an 8 mm x 4 mm tape and reel format per EIA-481 standard.

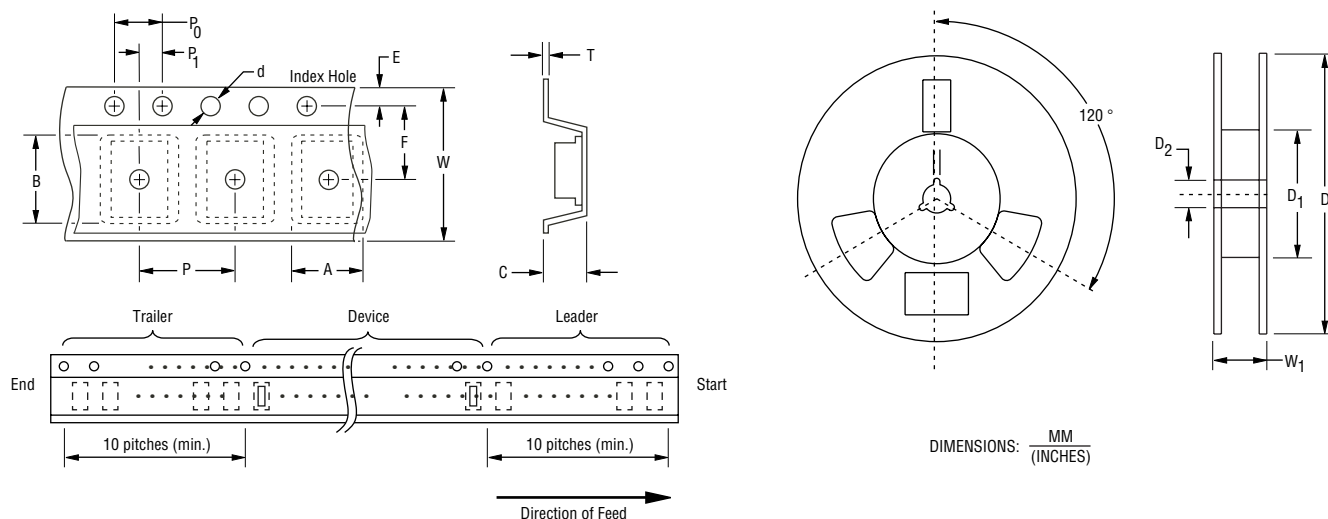

Item	Symbol	1005 (SOD323)
Carrier Width	A	$\frac{1.90 \pm 0.10}{(0.075 - 0.004)}$
Carrier Length	B	$\frac{4.30 \pm 0.10}{(0.169 - 0.004)}$
Carrier Depth	C	$\frac{1.80 \pm 0.10}{(0.071 - 0.004)}$
Sprocket Hole	d	$\frac{1.55 \pm 0.05}{(0.061 - 0.002)}$
Reel Outside Diameter	D	$\frac{178}{(7.008)}$
Reel Inner Diameter	D ₁	$\frac{80.0}{(3.150)}$ Min.
Feed Hole Diameter	D ₂	$\frac{13.0 \pm 0.20}{(0.512 - 0.008)}$
Sprocket Hole Position	E	$\frac{1.75 \pm 0.10}{(0.069 - 0.004)}$
Punch Hole Position	F	$\frac{3.50 \pm 0.05}{(0.138 - 0.002)}$
Punch Hole Pitch	P	$\frac{4.00 \pm 0.10}{(0.157 - 0.004)}$
Sprocket Hole Pitch	P ₀	$\frac{4.00 \pm 0.10}{(0.157 - 0.004)}$
Embossment Center	P ₁	$\frac{2.00 \pm 0.05}{(0.079 - 0.002)}$
Overall Tape Thickness	T	$\frac{0.20 \pm 0.10}{(0.008 - 0.004)}$
Tape Width	W	$\frac{8.00 \pm 0.20}{(0.315 - 0.008)}$
Reel Width	W ₁	$\frac{13.5}{(0.531)}$ Max.
Quantity per Reel	—	2,500

REV. 12/15

Specifications are subject to change without notice.
Customers should verify actual device performance in their specific applications.