

VICOR CONFIDENTIAL

THIS DOCUMENT AND THE DATA DISCLOSED HEREIN OR HEREWITH IS NOT TO BE REPRODUCED, USED, OR DISCLOSED IN WHOLE OR IN PART TO ANYONE WITHOUT PERMISSION OF VICOR CORP.

REV.	DESCRIPTION	DATE	APVD
1	RELEASED PER E100198	JS 02/26/10	REJH

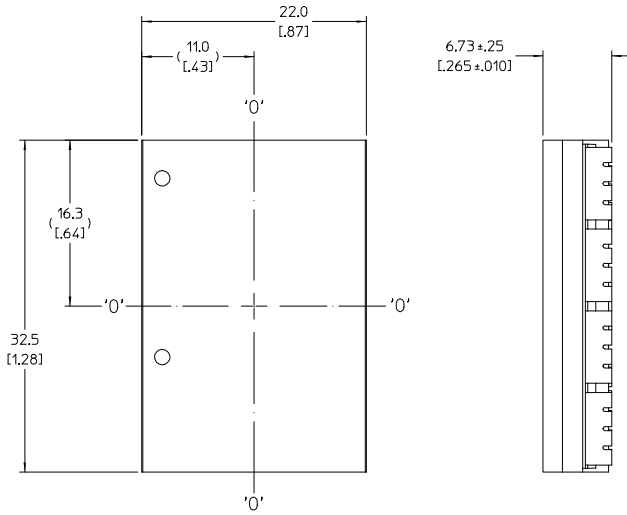

TOP VIEW (COMPONENT SIDE SHOWN)

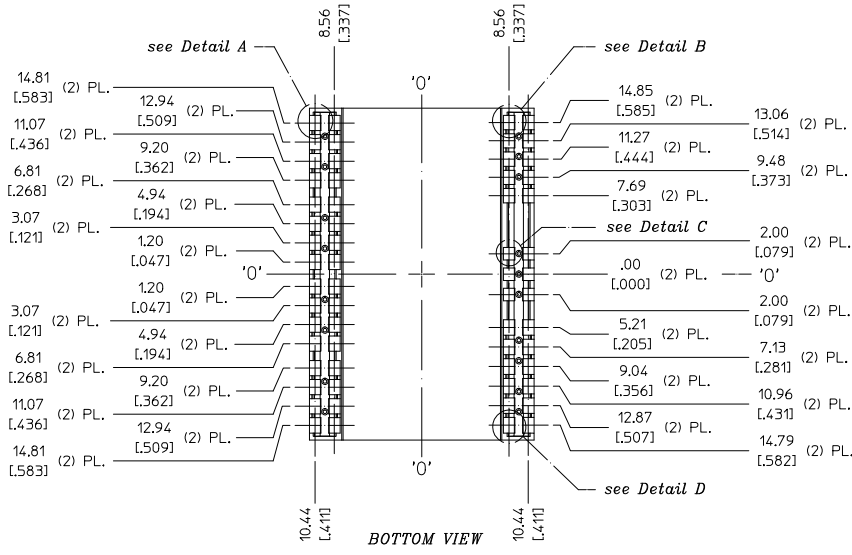
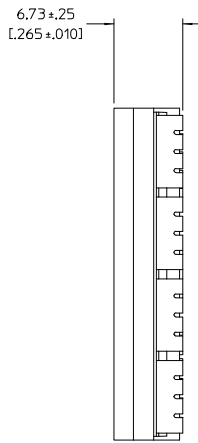

BOTTOM VIEW

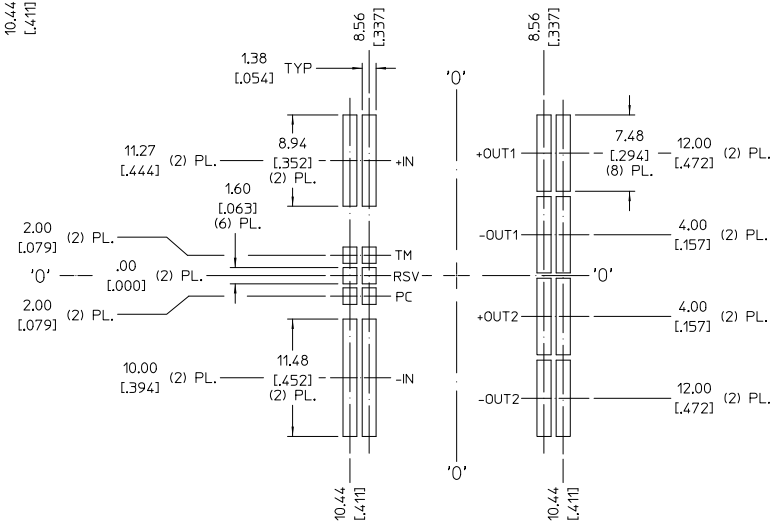
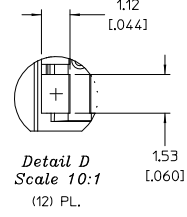
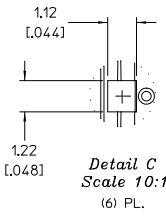
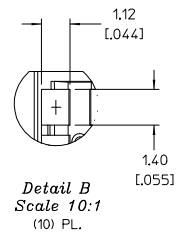
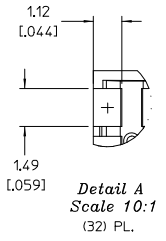
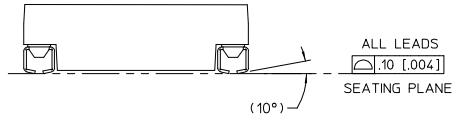

RECOMMENDED LAND PATTERN (COMPONENT SIDE SHOWN)

NOTE:
1. RoHS COMPLIANT PER CST-0001 LATEST REVISION.

DRAWN BY R.L. JIMENEZ	DATE 11/17/09	VICOR	
UNLESS OTHERWISE SPECIFIED DIMENSIONS ARE IN INCHES DIMENSIONS ARE TO BE HOLE DIMENSIONS ARE TO BE HOLE DIMENSIONS ARE TO BE HOLE		PRODUCT OUTLINE DWG BCM W/J-LEADS PKG3	
THIRD ANGLE PROJECTION	SCALE 4:1	CAGE CODE 67131	DWG NO 36058
DO NOT SCALE DRAWING	SCALE	SHEET 1	OF 1