

SX8634/35/44/45 Evaluation Kit

User's Guide

Table of Contents

1	Introduction.....	6
2	Getting Started.....	8
2.1	<i>Kit Contents.....</i>	8
2.2	<i>Installation/Quick Start.....</i>	9
2.3	<i>GUI tooltips and Help.....</i>	12
3	Hardware Description.....	13
3.1	<i>Overview.....</i>	13
3.1.1	USB Connector (#1).....	14
3.1.2	VREG (#2).....	14
3.1.3	EEPROM (#3).....	14
3.1.4	ON/OFF switch (#4).....	14
3.1.5	Test Switch (#5).....	14
3.1.6	Power Indication LED (#6).....	14
3.1.7	FT2232D (#7).....	14
3.1.8	Stand-alone Jumpers (#8).....	14
3.1.9	Header (#9).....	15
3.1.10	SX8634, SX8635, SX8644, SX8645 (#10).....	15
3.1.11	LEDs on GPIO[7..0] (#11).....	15
3.1.12	Touch Sensors (#12).....	15
3.2	<i>Default EVK hardware settings.....</i>	15
4	Guided Tour of the GUI/EVK.....	16
4.1	<i>Introduction.....</i>	16
4.2	<i>Active/Doze/Sleep Mode/Wake-up.....</i>	16
4.3	<i>LED fading on GPO pins.....</i>	16
4.4	<i>LED mapping on GPO pins.....</i>	18
4.5	<i>Sensors for buttons, slider or wheel.....</i>	18
4.6	<i>Monitor mode.....</i>	20
4.7	<i>Sensitivity.....</i>	22
5	GUI Description.....	24
5.1	<i>GUI Overview.....</i>	24
5.2	<i>File Menu.....</i>	25
5.2.1	Connect/Disconnect.....	25
5.2.2	Open SPM.....	25
5.2.3	Save SPM.....	26
5.2.4	Save SPM As.....	26
5.2.5	Exit.....	26
5.3	<i>Action Menu.....</i>	26
5.3.1	Refresh.....	26
5.3.2	Compensate offset.....	26
5.3.3	Operating mode.....	27
5.3.4	NVM burn.....	27
5.4	<i>Help Menu.....</i>	28
5.4.1	Overview.....	28
5.4.2	Help.....	28
5.4.3	User's Guide.....	28
5.4.4	About SX863x/4x Evaluation Kit.....	28
5.5	<i>Toolbar.....</i>	29
5.6	<i>Statusbar.....</i>	30
5.7	<i>Sensor Status.....</i>	31
5.8	<i>GUI tabs.....</i>	34
5.8.1	General tab.....	34
5.8.2	Cap Sensors tab.....	35
5.8.3	Buttons tab.....	39

ADVANCED COMMUNICATIONS & SENSING

5.8.4	Slider/Wheel tab	40
5.8.5	Mapping tab.....	41
5.8.6	GPIO tab	42
5.8.7	SPM/I2C tab	43
6	Schematics	45
7	Layout	53
8	References	61

Table of Figures

Figure 1: Typical Application.....	6
Figure 2: EVK Contents.....	8
Figure 3: EVK startup.....	9
Figure 4: SX864x EVK LEDs and sensors.....	9
Figure 5: SX863x EVK LEDs and sensors.....	10
Figure 6: EVK GUI window.....	10
Figure 7: button BT0 touched (SX864x) or proximity detected (Sx863x).....	11
Figure 8: tooltip example.....	12
Figure 9: SX8644EVK Board Picture.....	13
Figure 10: SX8645EVK Board Picture.....	13
Figure 11: Jumpers.....	14
Figure 12: Header.....	15
Figure 13: Operating Modes.....	16
Figure 14: GPIO tab modified (i).....	17
Figure 15: GPIO tab modified (ii).....	17
Figure 16: Mapping tab modified.....	18
Figure 17: Cap Sensors modified.....	19
Figure 18: Cap Sensors tab.....	20
Figure 19: Monitor tab.....	21
Figure 20: Select thresholds, hysteresis.....	21
Figure 21: two successive touches on button 0.....	22
Figure 22: sensitivity (5) of button 0.....	22
Figure 23: sensitivity (0) of button 0, sensitivity (1) of button 0.....	23
Figure 24: SX8634/44 GUI Overview.....	24
Figure 25: SX8635/45 GUI Overview.....	24
Figure 26: File Menu.....	25
Figure 27: SPM File Example (begin).....	25
Figure 28: SPM File Example (end).....	26
Figure 29: Action Menu.....	26
Figure 30: Operating Mode.....	27
Figure 31: Confirm NVM burn.....	27
Figure 32: Confirmation NVM is burned.....	27
Figure 33: GUI Help Menu.....	28
Figure 34: About window.....	28
Figure 35: Toolbar.....	29
Figure 36: I2C address.....	29
Figure 37: Statusbar.....	30
Figure 38: Statusbar with error message.....	30
Figure 39: Statusbar with SPM file.....	30
Figure 40: Sensor status for SX8634/44EVK and SX8634/45EVK.....	31
Figure 41: Example BT0 and BT2 touched.....	32
Figure 42: Example slider touched.....	32
Figure 43: Example slider move high and move low.....	33
Figure 44: Example wheel touched.....	33
Figure 45: Example wheel move counter clock wise and move clock wise.....	33
Figure 46: general tab.....	34
Figure 47: cap sensors tab.....	35
Figure 48: monitor enabled.....	35
Figure 49: monitor window.....	36
Figure 50: show/hide monitor signals.....	36
Figure 51: example: super pose thresholds of button 0.....	37
Figure 52: graph pop up window.....	38

ADVANCED COMMUNICATIONS & SENSING

<i>Figure 53: buttons tab</i>	39
<i>Figure 54 slider or wheel tab</i>	40
<i>Figure 55 mapping tab</i>	41
<i>Figure 56 GPIO tab</i>	42
<i>Figure 57 SPM/I2C tab</i>	43
<i>Figure 58 SPM expanding General</i>	44
<i>Figure 59: SX8644EVK schematic page 1/2</i>	45
<i>Figure 60: SX8644EVK schematic page 2/2</i>	46
<i>Figure 61: SX8645EVK schematic page 1/2</i>	47
<i>Figure 62: SX8645EVK schematic page 2/2</i>	48
<i>Figure 63: SX8634EVK schematic page 1/2</i>	49
<i>Figure 64: SX8634EVK schematic page 2/2</i>	50
<i>Figure 65: SX8635EVK schematic page 1/2</i>	51
<i>Figure 66: SX8635EVK schematic page 2/2</i>	52
<i>Figure 67: SX8644EVK top layer</i>	53
<i>Figure 68: SX8644EVK mid layer 1</i>	53
<i>Figure 69: SX8644EVK mid layer 2</i>	54
<i>Figure 70: SX8644EVK bottom layer</i>	54
<i>Figure 71: SX8645EVK top layer</i>	55
<i>Figure 72: SX8645EVK mid layer 1</i>	55
<i>Figure 73: SX8645EVK mid layer 2</i>	56
<i>Figure 74: SX8645EVK bottom layer</i>	56
<i>Figure 67: SX8634EVK top layer</i>	57
<i>Figure 72: SX8634EVK mid layer 1</i>	57
<i>Figure 73: SX8634EVK mid layer 2</i>	58
<i>Figure 74: SX8634EVK bottom layer</i>	58
<i>Figure 67: SX8635EVK top layer</i>	59
<i>Figure 72: SX8635EVK mid layer 1</i>	59
<i>Figure 73: SX8635EVK mid layer 2</i>	60
<i>Figure 74: SX8635EVK bottom layer</i>	60
<i>Figure 75: SX8634/44EVK, SX8635/45EVK stacked layer information</i>	60

1 Introduction

This document describes the evaluation kits of the:

- SX8634 (proximity, buttons and slider)
- SX8635 (proximity, buttons and wheel)
- SX8644 (buttons and slider)
- SX8645 (buttons and wheel)

In this user guide the term EVK refers to the SX8634EVK, SX8635EVK, SX8644EVK and SX8645EVK

The SX863x and SX864x family (see references [1] to [13]), is an ultra low power, fully integrated 12 (or 8) -channel solution for capacitive touch-buttons, slider and wheel and proximity applications with enhanced LED drivers. The SX863x/4x family features dedicated capacitive sense inputs (that requires no external components) in addition to 8 general purpose I/O ports (GPIO). Each GPIO is typically configured as LED driver with independent PWM source for enhanced lighting control such as intensity and fading. SX863x offers additionally proximity detection.

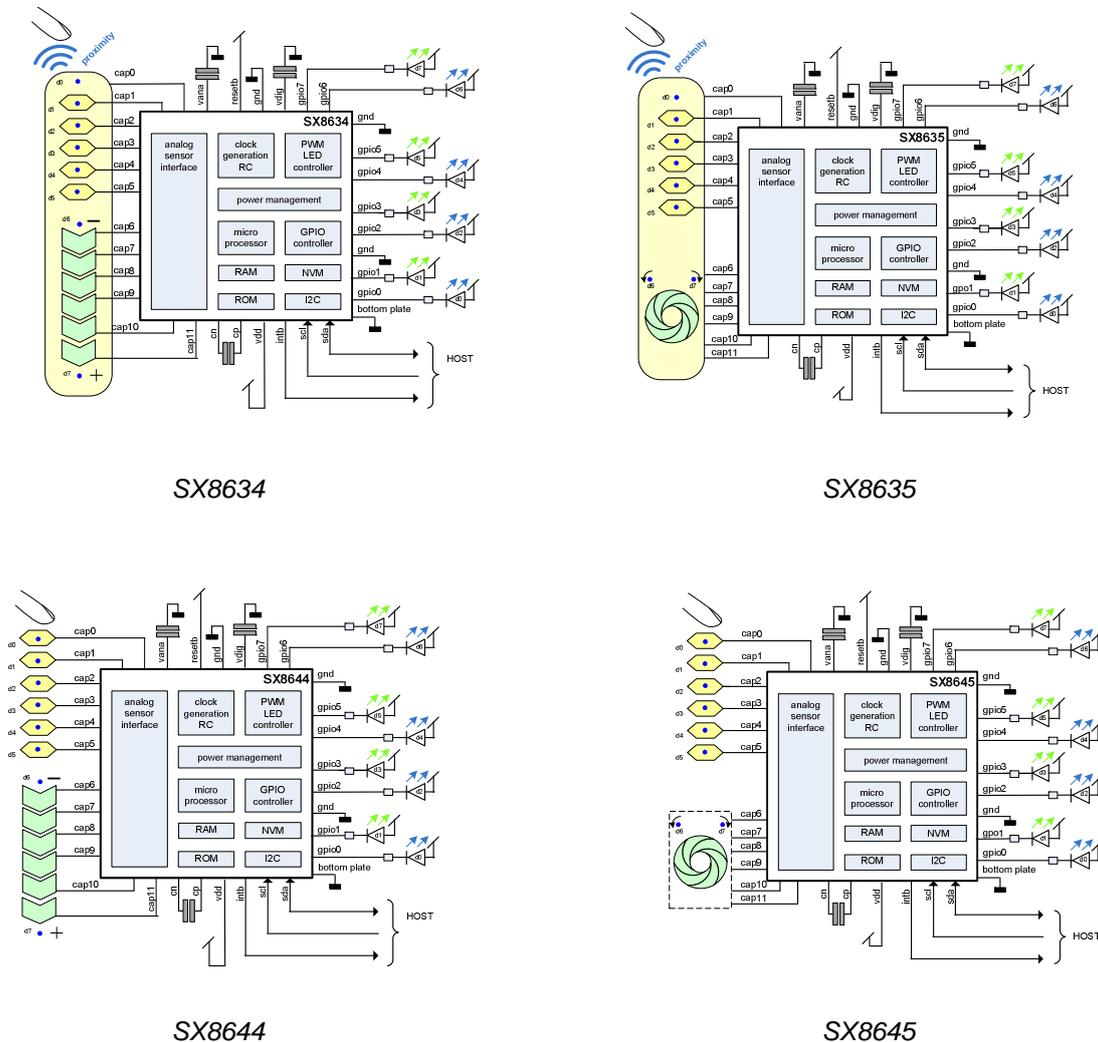

Figure 1: Typical Application

ADVANCED COMMUNICATIONS & SENSING

SX863x and SX864x main features include:

- ◆ Proximity Sensing (for SX863x Family)
- ◆ Complete 12 Sensors Capacitive Touch Controller for Buttons and Slider
 - Pre-configured for 6 Buttons and a Slider (SX8644), Wheel (SX8645)
 - 8 LED Drivers with Individual Intensity, Fading Control and Autolighting Mode
 - 256 steps PWM Linear and Logarithmic control
- ◆ High Resolution Capacitive Sensing
 - Up to 100pF of Offset Capacitance Compensation at Full Sensitivity
 - Capable of Sensing through Overlay Materials up to 5mm thick
- ◆ Extremely Low Power Optimized for Portable Application
 - 8uA (typ) in Sleep Mode
 - 80uA (typ) in Doze Mode (Scanning Period 195ms)
 - 260uA (typ) in Active Mode (Scanning Period 30ms)
- ◆ Programmable Scanning Period from 15ms to 1500ms
- ◆ Auto Offset Compensation
 - Eliminates False Triggers due to Environmental Factors (Temperature, Humidity)
 - Initiated on Power-up and Configurable Intervals
- ◆ Multi-Time In-Field Programmable Firmware Parameters for Ultimate Flexibility
 - On-chip user programmable memory for fast, self contained start-up
- ◆ "Smart" Wake-up Sequence for Easy Activation from Doze
- ◆ No External Components per Sensor Input
- ◆ Internal Clock Requires No External Components
- ◆ Differential Sensor Sampling for Reduced EMI
- ◆ 400 KHz Fast-Mode I²C Interface with Interrupt

2 Getting Started

2.1 Kit Contents

As illustrated in the figure below, the Evaluation kit is composed of:

- SX8634EVK, SX8635EVK, SX8644EVK, SX8645EVK board with 2mm acrylic glass overlay.
- CDROM including all necessary PC software and documentation (requires min. Windows XP)
- Mini USB cable to connect the SX8634EVK, SX8635EVK, SX8644EVK, SX8645EVK board to the PC

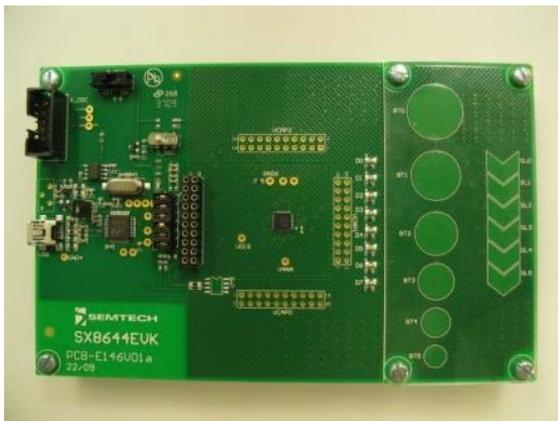

SX8644EVK

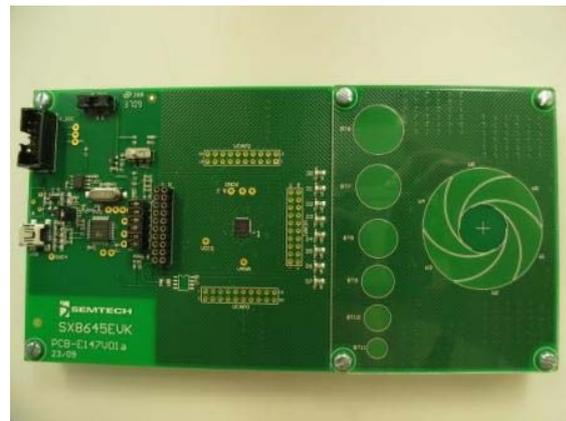

SX8645EVK



SX8634EVK



SX8635EVK

Figure 2: EVK Contents

2.2 Installation/Quick Start

- 1- Put the CDROM in your computer. If the installation does not start automatically, launch "SX863xSX864xEvaluationKitSetup.exe" manually.
- 2- Follow installation guidelines until the process is completed. Please note that .NET Framework 3.5 and the FTDI USB driver will be automatically downloaded/installed if not detected on your computer.
- 3- For SX864x only: Assure the switch #5 is always in the left position.
- 4- Set the ON/OFF switch (#4) to OFF (left position).
- 5- Connect the EVK board to the PC with the mini USB cable to connector #1.

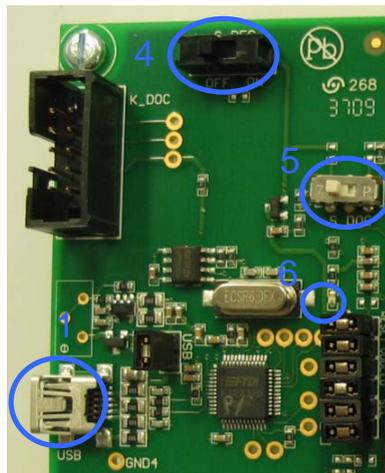

Figure 3: EVK startup

- 6- The PC will recognize the EVK.
- 7- Set the ON/OFF switch (#4) to ON (right position).
- 8- The red LED (#6) will light up

The EVK is now ready to be used in stand alone demo mode (without GUI). Touching the buttons BT0 to BT5 (#12) will enable the corresponding green LEDs (#11), D0 to D5. Releasing the buttons will turn off the LEDs.

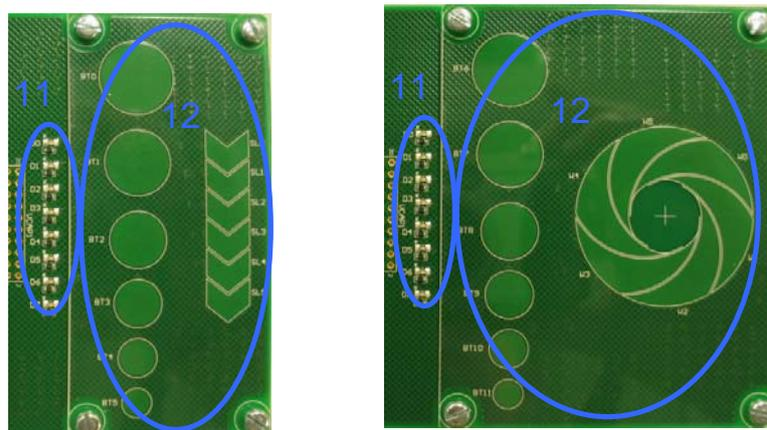

Figure 4: SX864x EVK LEDs and sensors

ADVANCED COMMUNICATIONS & SENSING

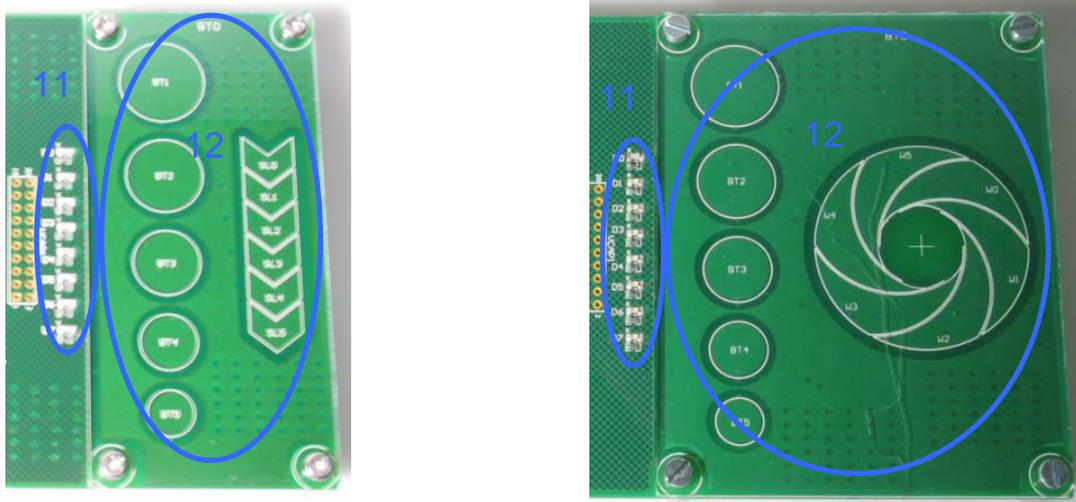

Figure 5: SX863x EVK LEDs and sensors

Moving a finger on the slider or wheel (#12) will enable the green LEDs (#11), D6 and D7 depending on the direction of the finger.
For the SX863x the orange LED (d0) will show proximity as soon as the user approaches the EVK.

For more detailed evaluation and changing the default configuration of the EVK the GUI needs to be started.

- 9- Launch "Sx863xSX864xEVK" from PC Start menu.
- 10- The EVK will be connected automatically and the following window will appear.
(In case the auto connect did not succeed: Click on "Disconnect/Connect" button  in toolbar or select 'Connect' in File menu)

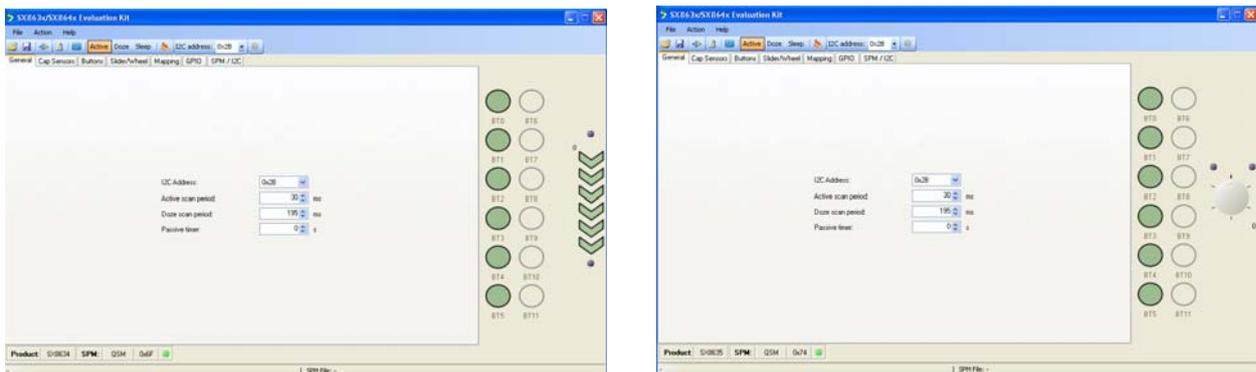

Figure 6: EVK GUI window

The product is shown in the left bottom corner of the GUI.

- 11- a) SX864x: Touch with your finger a button (e.g. BT0) on the EVK and the GUI shows BT0 is touched (white).
- b) Sx863x: Approach with your finger the EVK and the Gui shows proximity detection (BT0 touched, white)



Figure 7: button BT0 touched (SX864x) or proximity detected (Sx863x)

The EVK and GUI are operational.

2.3 GUI tooltips and Help

All GUI buttons, LEDs, scroll bars, icons have tooltips which show briefly the functionality. The tooltips can be activated by the user by moving the mouse over the desired area (see example I2C address selection).



Figure 8: tooltip example

3 Hardware Description

The EVK boards are described in this chapter. Please refer to the schematics and layout provided at the end of the document for more details about the exact hardware implementation.

3.1 Overview

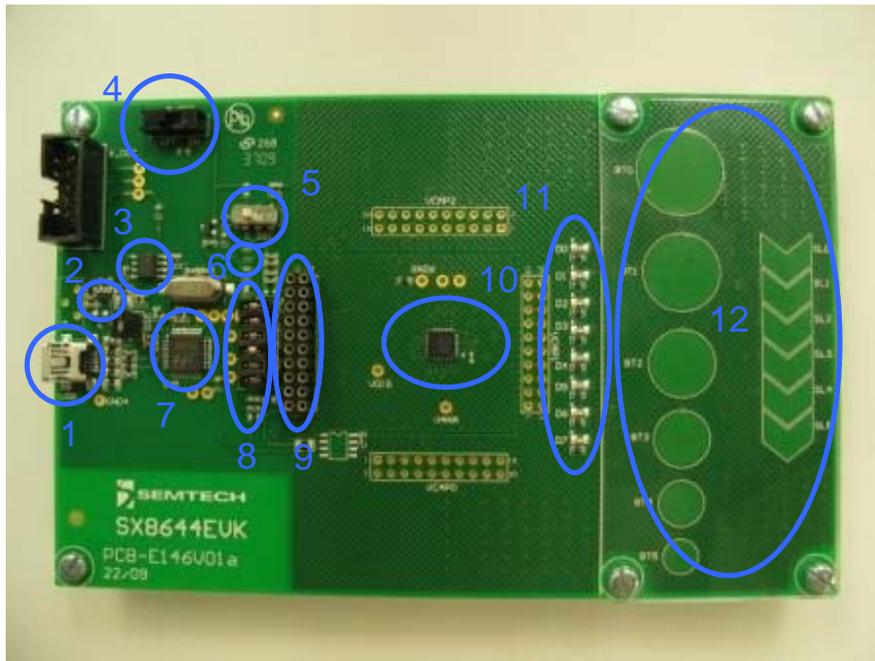

Figure 9: SX8644EVK Board Picture

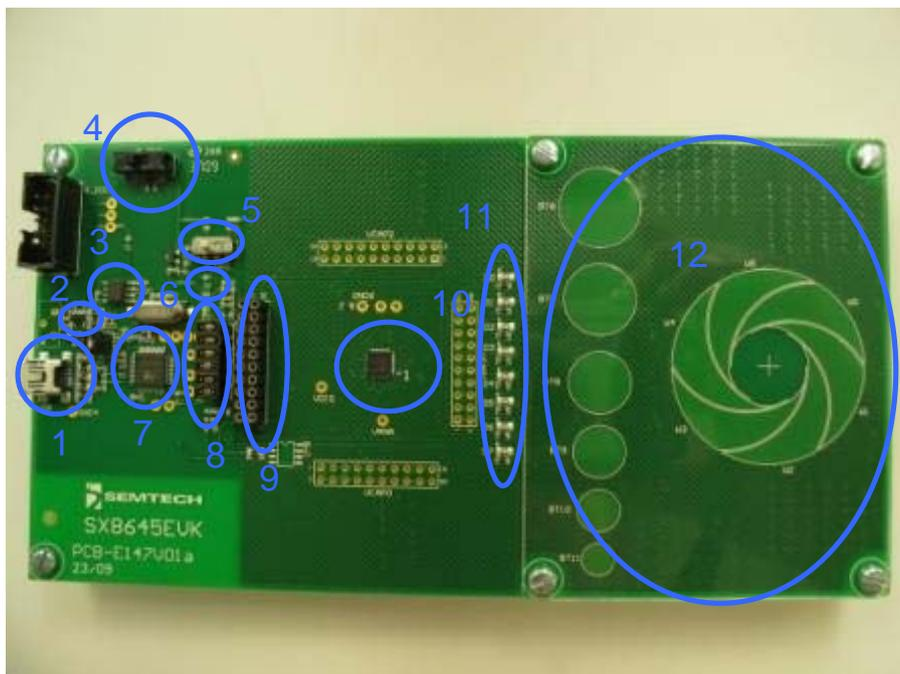

Figure 10: SX8645EVK Board Picture

ADVANCED COMMUNICATIONS & SENSING**3.1.1 USB Connector (#1)**

The USB connector allows the EVK to be connected to a PC from which it will get its power and configuration/control commands via the dedicated software.

3.1.2 VREG (#2)

VREG is fixed to the typical operating voltage of 3.3V using the Semtech Sc153 voltage regulator, ensuring correct I2C communication between the SX863x/4x and the FT2232D.

3.1.3 EEPROM (#3)

FT2232D is associated to an EEPROM which keeps the FTDI chip's parameters when power is turned off. The EEPROM is used to customize USB device description.

3.1.4 ON/OFF switch (#4)

The ON/OFF switch turns ON (right position) or OFF (left position) the supply for the SX863x/4x and at the same time the red power indication LED (#6).

3.1.5 Test Switch (#5)

Only applicable for SX864x:

This switch is for Semtech internal use and needs to be always in the left position.

The EVK will not operate if this switch is in the wrong position.

3.1.6 Power Indication LED (#6)

The red LED indicates if the SX863x/4x are turned ON or OFF, according the position of switch (#4).

3.1.7 FT2232D (#7)

The FT2232D from FTDI will be used as a USB to I2C bridge between the PC and the SX863x/4x; moreover it will also monitor and control RESETB and INTB signals (similar to what a host would do in a final application).

The USB bridge is supplied directly over the USB cable.

3.1.8 Stand-alone Jumpers (#8)

These six jumpers are connecting the FT2232D bridge to the SX863x/4x.

Their purpose is, as their name suggests, being able to disconnect the SX863x/4x from the rest of the circuitry to access it externally (with an external host, sharing another I2C bus, etc.).



Figure 11: Jumpers

3.1.9 Header (#9)

The header, 2x 10 pins allows the user connect to the different signals on the board e.g. for monitoring purposes.

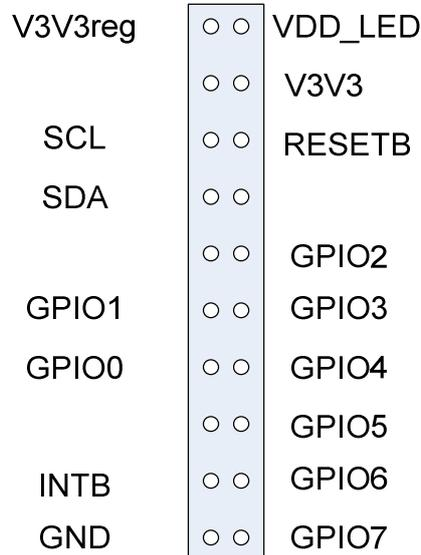

Figure 12: Header

3.1.10 SX8634, SX8635, SX8644, SX8645 (#10)

The Semtech Touch controller product.

3.1.11 LEDs on GPIO[7..0] (#11)

Eight green LEDs (D0..D7) are connected to the eight GPIOs of the SX8644 or SX8645 for visual feedback. Seven green LEDs (D1..D7) and one orange LED (D0, proximity) are connected to the eight GPIOs of the SX8634 or SX8635 for visual feedback.

3.1.12 Touch Sensors (#12)

Different size touch buttons and slider, wheel are connected to the SX863x/4x. The sensor area is covered by 2 mm thick transparent, acrylic glass.

3.2 Default EVK hardware settings.

Default settings of jumpers and switches:

- All jumpers need to be mounted.
- The ON/OFF switch (#4) can be in ON (right position) or OFF (left position).
- SX864x: The test switch (#5) needs to be in the left position.

4 Guided Tour of the GUI/EVK

4.1 Introduction

The paragraphs in this chapter allow the user to get to know the basics of the EVK and the SX863x/4x and to get the user acquainted with the GUI and the EVK and the way to use them.

The more technical details and functioning are described in following chapters and in the product datasheets (references [1] to [13]).

The steps in this chapter are straight forward and do not require a very detailed knowledge of the SX863x/4x neither of the EVK.

4.2 Active/Doze/Sleep Mode/Wake-up

Directly after a power up of the EVK the SX863x/4x will enter Active mode and sensor pins will be sensed every 30ms.

The user can change the operation mode by clicking on the icons.

The actual operation mode is then highlighted as shown below.



Figure 13: Operating Modes

The sensor pins are sensed every 195 ms in Doze Mode.

There are 2 ways from Doze mode to Active mode.

- 1) Use the Operating mode icon Active
- 2) Touching the button BT0 for at least 195ms. After the release of BT0 the Active mode is entered automatically. This is the so-called automatic wakeup. In case other buttons are touched nothing happens and Doze mode is maintained.

4.3 LED fading on GPO pins

Touching BT0 will enable LED D0 on the EVK.

When BT0 is released the LED will remain on for some time and then go OFF slowly.

It is easy to change the LED behavior by the following steps.

- select the GPIO tab

ADVANCED COMMUNICATIONS & SENSING

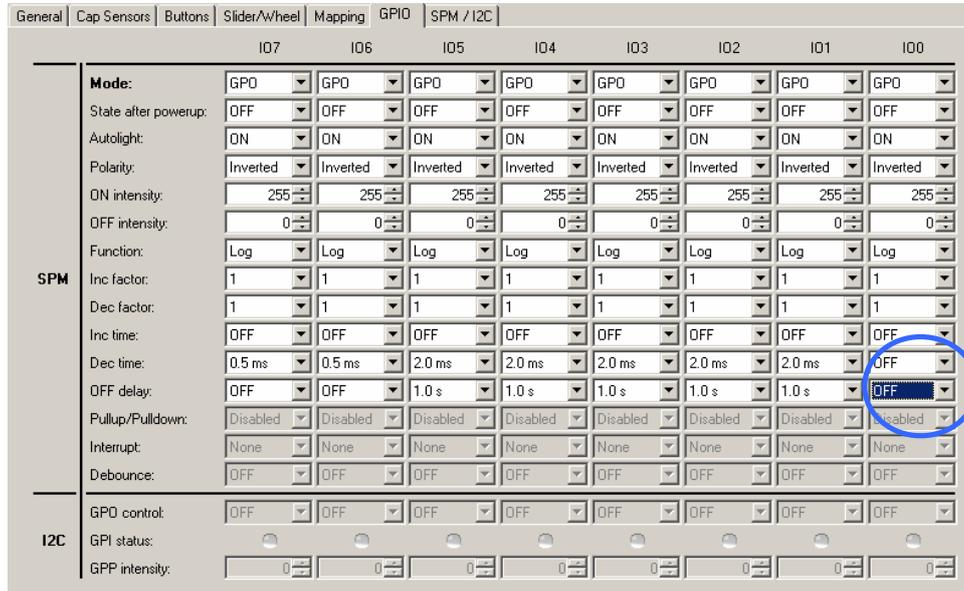

Figure 14: GPIO tab modified (i)

Change the Dec time (default 2ms) and OFF delay (default 1.0s) to OFF. Each modification on this tab is immediately written to the EVK. After this is done the LED will turn off directly after a release.

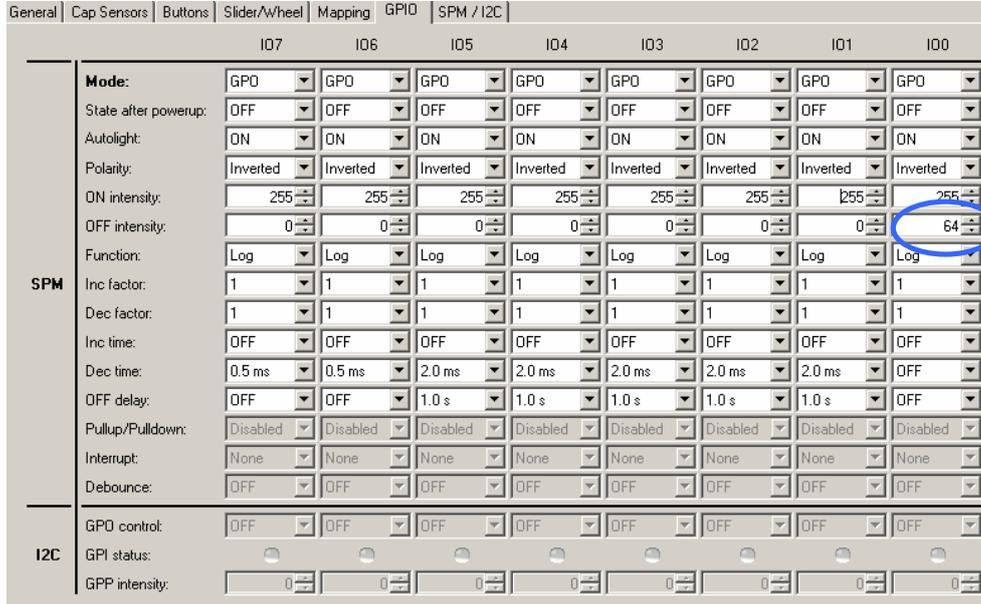

Figure 15: GPIO tab modified (ii)

Change the OFF intensity (default 0) to 64. The LED D0 will be enabled at very low brightness in the OFF state.

ADVANCED COMMUNICATIONS & SENSING

4.4 LED mapping on GPO pins

LED D0 on the EVK is mapped to button BT0.
It is easy to map LED D0 to another button and e.g. swap with button1

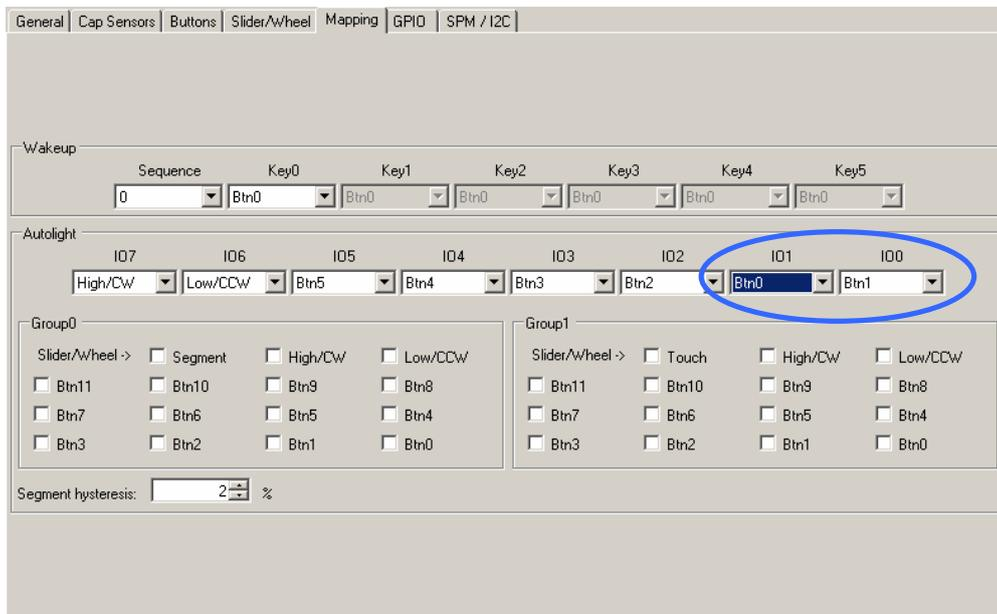

Figure 16: Mapping tab modified

In the example above LED D0 is mapped to Button 1 (default is button 0) and LED D1 is mapped to button 0 (default is button 1).

4.5 Sensors for buttons, slider or wheel

The SX8634/44 and SX8635/45 start up with six buttons and six sensors in the slider or wheel. This can be easily changed in the Cap Sensor tab.

The configuration below shows a example which uses a slider with 5 sensors (6 per default), the buttons 0, 2, and 4 were turned off to save power consumption and button 6 was enabled.

ADVANCED COMMUNICATIONS & SENSING

General | Cap Sensors | Buttons | Slider/Wheel | Mapping | GPIO | SPM / I2C

Individual sensitivity: ON OFF

	Cap0	Cap1	Cap2	Cap3	Cap4	Cap5	Cap6	Cap7	Cap8	Cap9	Cap10	Cap11
Mode:	OFF	Button	OFF	Button	OFF	Button	Button	Slider	Slider	Slider	Slider	Slider
Sensitivity:	5	5	5	5	5	7	5	5	5	5	5	5
Thresh:	640	640	640	640	640	512	448	448	448	448	448	448

Periodic offset compensation: Disabled

Data monitoring

	Cap0	Cap1	Cap2	Cap3	Cap4	Cap5	Cap6	Cap7	Cap8	Cap9	Cap10	Cap11
Raw:	-149	-83	-100	-20	-85	-20	-100	-124	-125	-113	-75	-84
Avg:	-185	-86	-118	-29	-115	-43	-154	-138	-149	-137	-149	-147
Diff:	0	47	57	31	0	0	1	41	57	40	80	38
Peak-Peak:	48	50	39	22	32	23	53	37	33	20	15	25
Noise RMS:	36	3	18	9	30	23	54	14	24	24	74	63

Start 

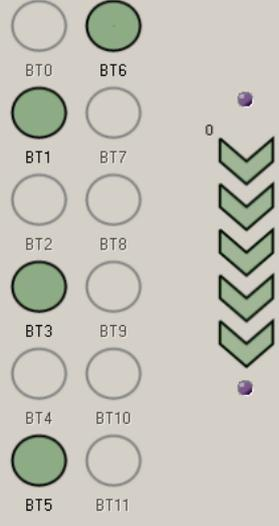

Figure 17: Cap Sensors modified

The GUI shows at the right side the modified users configuration. Green icons are enabled sensors and the grey icons are disabled sensors.

4.6 Monitor mode

Touching a sensor does not always mean the EVK will consider this as a touch.

It might e.g. be that the touch is only partly on the sensor area or maybe the overlay material is replaced by something thicker.

The EVK parameters are set such that sensor area, overlay material and thickness are operational.

In case the user changes the hardware or just needs to observe raw signals the GUI can be set in monitor mode.

Follow the next steps:

-select the Cap Sensors tab

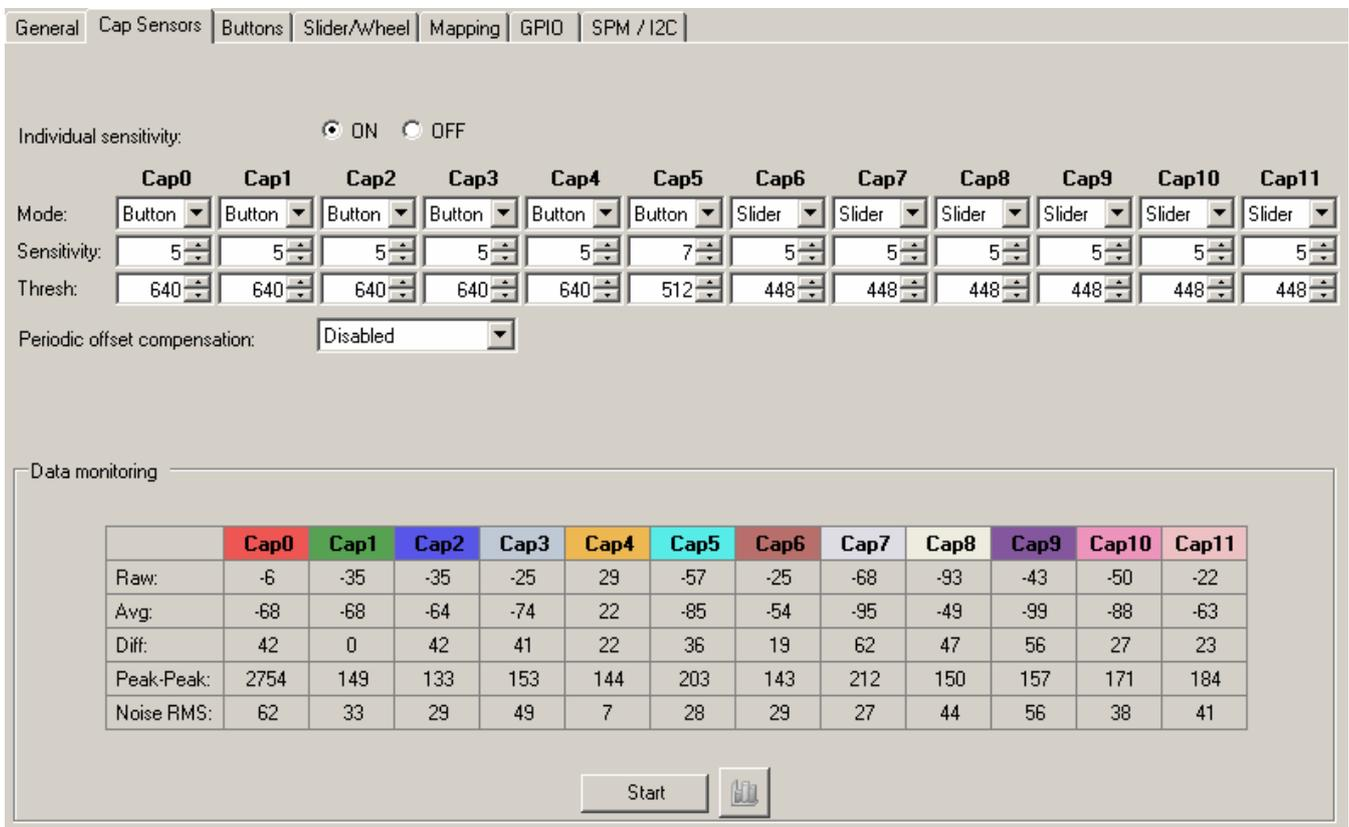

Individual sensitivity: ON OFF

	Cap0	Cap1	Cap2	Cap3	Cap4	Cap5	Cap6	Cap7	Cap8	Cap9	Cap10	Cap11
Mode:	Button	Button	Button	Button	Button	Button	Slider	Slider	Slider	Slider	Slider	Slider
Sensitivity:	5	5	5	5	5	7	5	5	5	5	5	5
Thresh:	640	640	640	640	640	512	448	448	448	448	448	448

Periodic offset compensation: Disabled

	Cap0	Cap1	Cap2	Cap3	Cap4	Cap5	Cap6	Cap7	Cap8	Cap9	Cap10	Cap11
Raw:	-6	-35	-35	-25	29	-57	-25	-68	-93	-43	-50	-22
Avg:	-68	-68	-64	-74	22	-85	-54	-95	-49	-99	-88	-63
Diff:	42	0	42	41	22	36	19	62	47	56	27	23
Peak-Peak:	2754	149	133	153	144	203	143	212	150	157	171	184
Noise RMS:	62	33	29	49	7	28	29	27	44	56	38	41

Start 

Figure 18: Cap Sensors tab

- then push the Start button at the bottom.

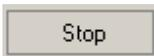
- a stop button  and the monitor icon  will appear.

- click on the monitor icon.

- a window appears with the sensor data.

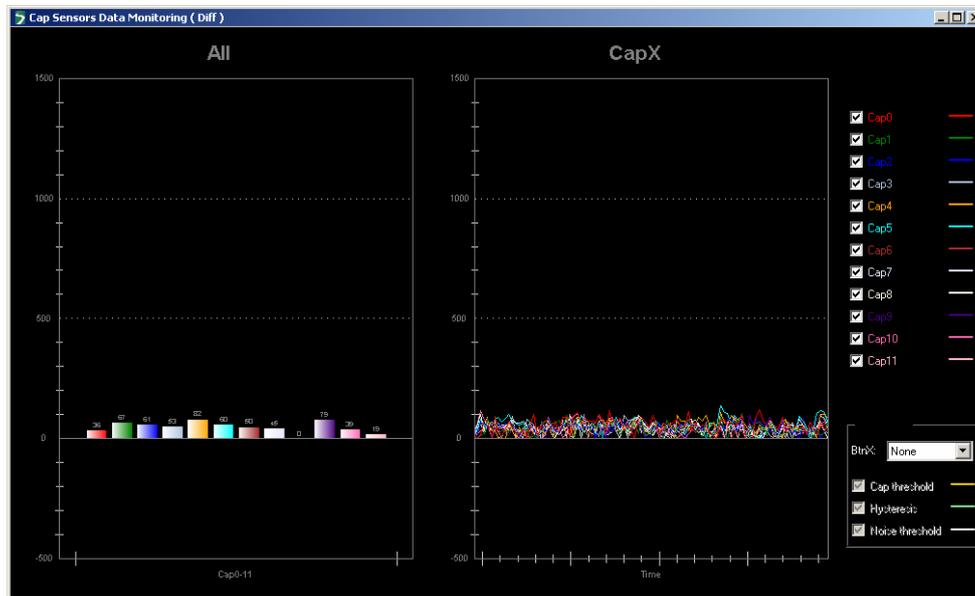

Figure 19: Monitor tab

The left graph shows the current values of all enabled sensors.
 The right graph shows the sensor values over time (like an oscilloscope).

- select button 0 in the lower right corner



Figure 20: Select thresholds, hysteresis

This will superpose the detection threshold and hysteresis (yellow and green lines) on the graphs.
 If one touches button0 and the red signal goes above the threshold+hysteresis the SX8644 or SX8645 considers that as a touch.
 If the signal goes below the threshold – hysteresis the button is released.

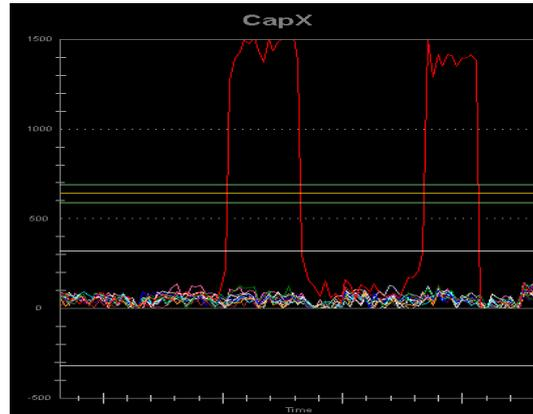

Figure 21: two successive touches on button 0

- click on the stop button  on the Cap Sensor tab to go back to normal mode.

4.7 Sensitivity

The sensor sensitivity needs to be adapted to the thickness of the overlay, permittivity of the overlay, the size of the buttons and detection thresholds.

The following shows a typical example of changing the sensitivity of the sensors using the EVK.

If the user touches button 0 as in the previous section then the sensor values are relatively large as the threshold is passed with a lot off margin.

The sensitivity of a button can be modified easily in the Cap Sensors Tab.

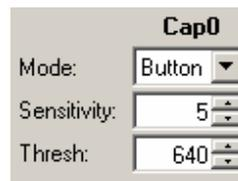

Figure 22: sensitivity (5) of button 0

The default sensitivity for button 0 is five. A lower sensitivity would operate as well for button 0. Going into monitor mode as described in the previous section is required to observe the sensor signal and thresholds and hysteresis.

ADVANCED COMMUNICATIONS & SENSING

Figure 23: sensitivity (0) of button 0,

sensitivity (1) of button 0

The above figures show that button 0 requires at least a sensitivity of 1 to pass the detection threshold and hysteresis (green)

If the sensitivity is set to 0 the sensor values are not large enough to exceed the threshold and a touch will never be detected.

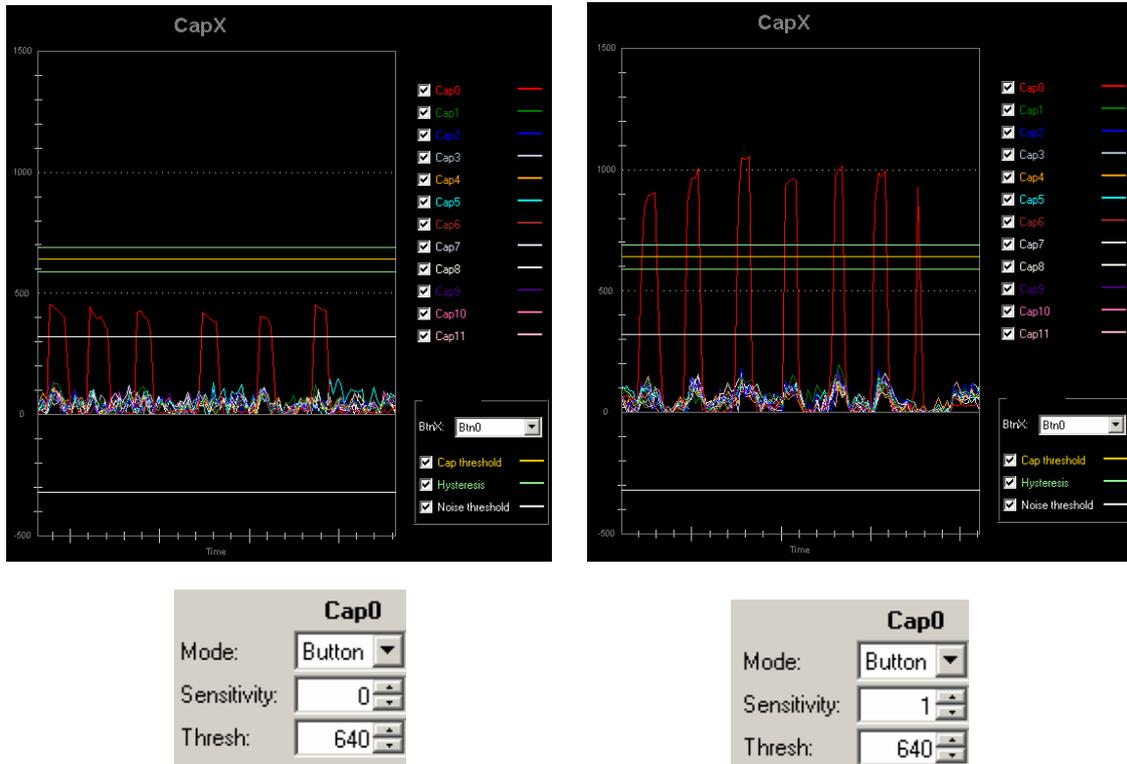
5 GUI Description

5.1 GUI Overview

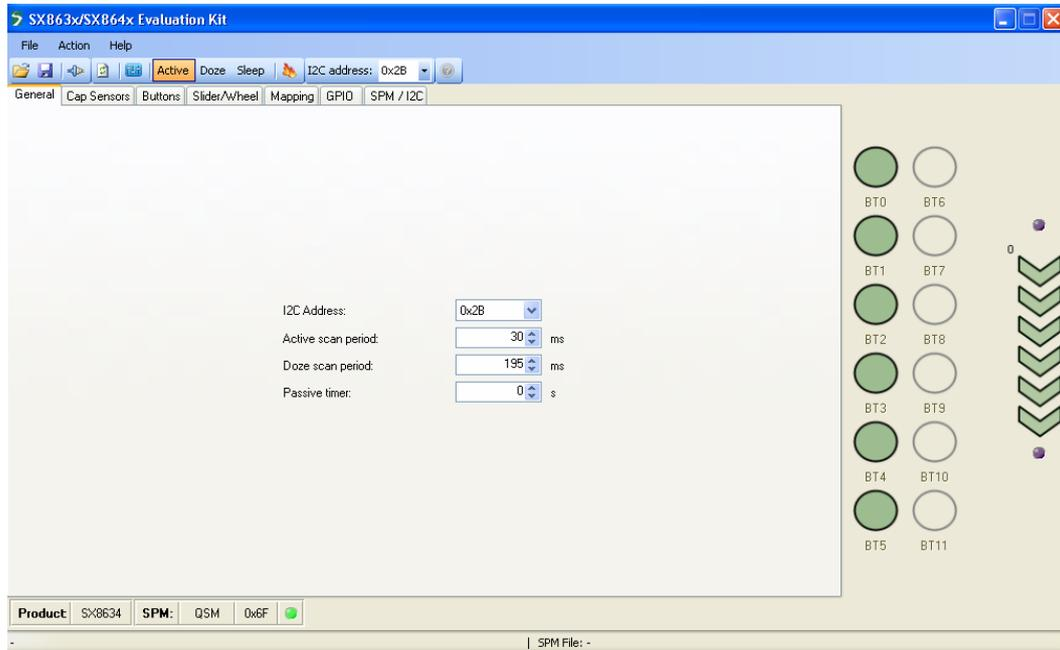

Figure 24: SX8634/44 GUI Overview

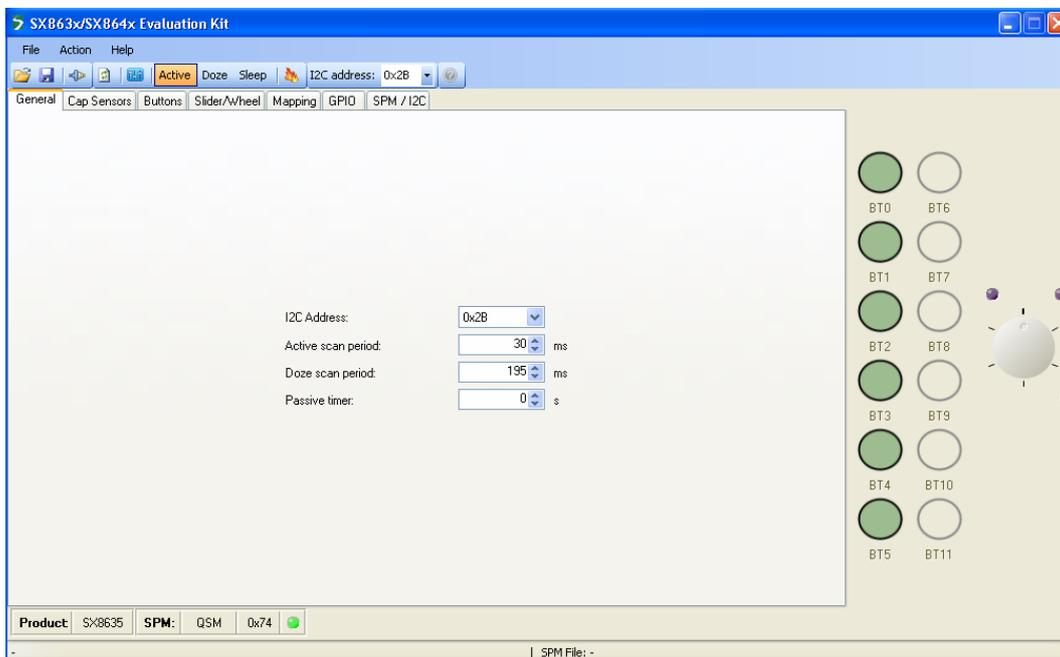

Figure 25: SX8635/45 GUI Overview

5.2 File Menu

File menu contains general purpose functions. Most of them can also be accessed on the toolbar by clicking directly on the icon.

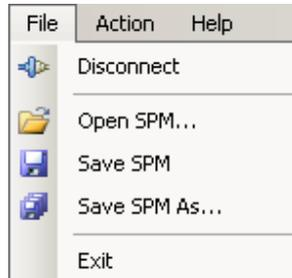

Figure 26: File Menu

5.2.1 Connect/Disconnect

This item is used to connect/disconnect the GUI to/from the EVK.

The icon and name of the menu item dynamically changes depending on the current connection state.

This feature is also available directly on the toolbar. 

5.2.2 Open SPM

The GUI offers the possibility to save/load the SPM parameters into/from a file.

The “Open SPM” feature reads a SPM file, stored on the PC, and copies the content to the SPM of the SX863x/4x.

This feature is also available directly on the toolbar. 

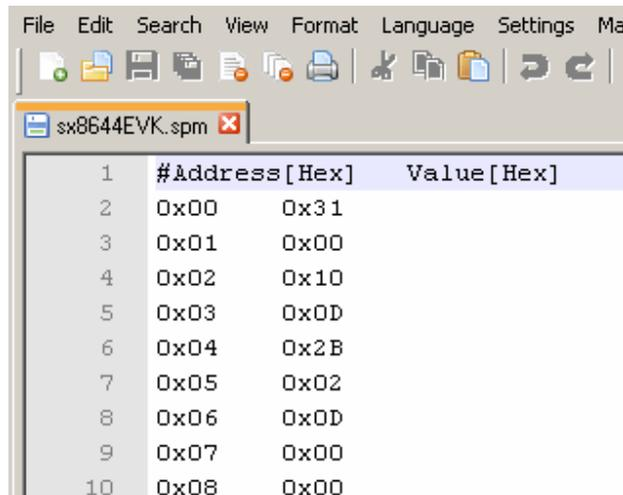

	#Address [Hex]	Value [Hex]
1	0x00	0x31
2	0x01	0x00
3	0x02	0x10
4	0x03	0x0D
5	0x04	0x2B
6	0x05	0x02
7	0x06	0x0D
8	0x07	0x00
9	0x08	0x00
10	0x08	0x00

Figure 27: SPM File Example (begin)

The SPM files contain 128 data bytes for the address 0x00 to 0x7F.

The end of the SPM file is shown below.

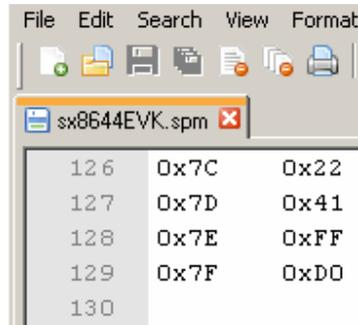

Figure 28: SPM File Example (end)

5.2.3 Save SPM

This feature saves the current SPM from the SX863x/4x in the currently opened SPM file and overriding it. after confirmation by the user.

This feature is also available directly on the toolbar. 

5.2.4 Save SPM As

This is the standard derivate of the “Save SPM” feature used to save the current SPM to a different name.

5.2.5 Exit

This item closes the GUI.

5.3 Action Menu

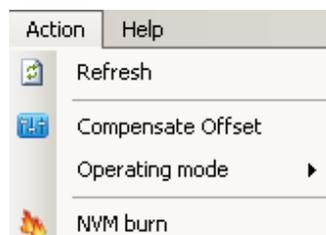

Figure 29: Action Menu

5.3.1 Refresh

This item is used to read values from the EVK to update the GUI in case these both are out of sync.

This feature is also available directly on the toolbar. 

5.3.2 Compensate offset

This item is used to force a compensation of parasitic capacitances.

By clicking on the item the GUI issues the I2C command to start the compensating procedures in the SX863x/4x.

This feature is also available directly on the toolbar. 

5.3.3 Operating mode

This item is used to change the operating mode of the EVK.
This feature is also available directly on the toolbar.

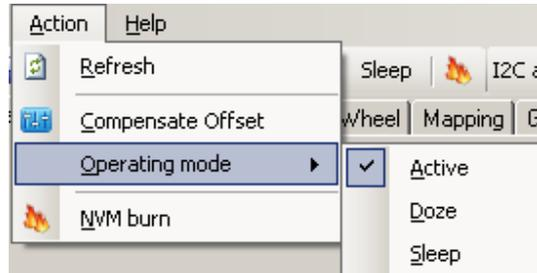

Figure 30: Operating Mode

5.3.4 NVM burn

This item is used to write permanently the SPM content in the NVM.

This feature is also available directly on the toolbar. 

The NVM can be burned three times so the burn feature needs to be selected with precaution.

By selecting the item the user needs to confirm the NVM burn.
The burn is confirmed by entering the key "A55A" and by selecting the Yes button.

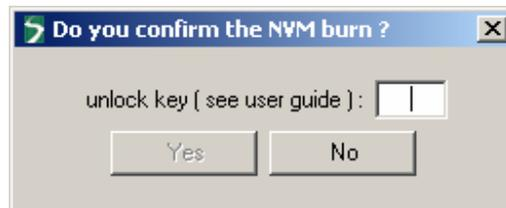

Figure 31: Confirm NVM burn

After the NVM burn the GUI will inform the user the NVM burning is terminated.



Figure 32: Confirmation NVM is burned

After a power down-power up sequence the EVK will start up with the new settings.

5.4 Help Menu

5.4.1 Overview

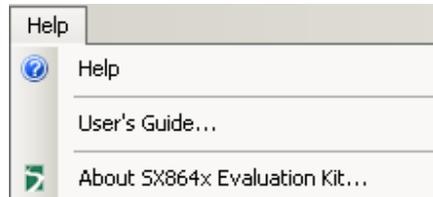

Figure 33: GUI Help Menu

5.4.2 Help

This item shows or hides the help window. The help window shows useful information when the user moves the mouse over GUI items, registers etc...

This feature is also available directly on the toolbar. 

5.4.3 User's Guide

This item opens the User's guide (pdf).

5.4.4 About SX863x/4x Evaluation Kit

This item shows the versions of the GUI and SX863x/4x.

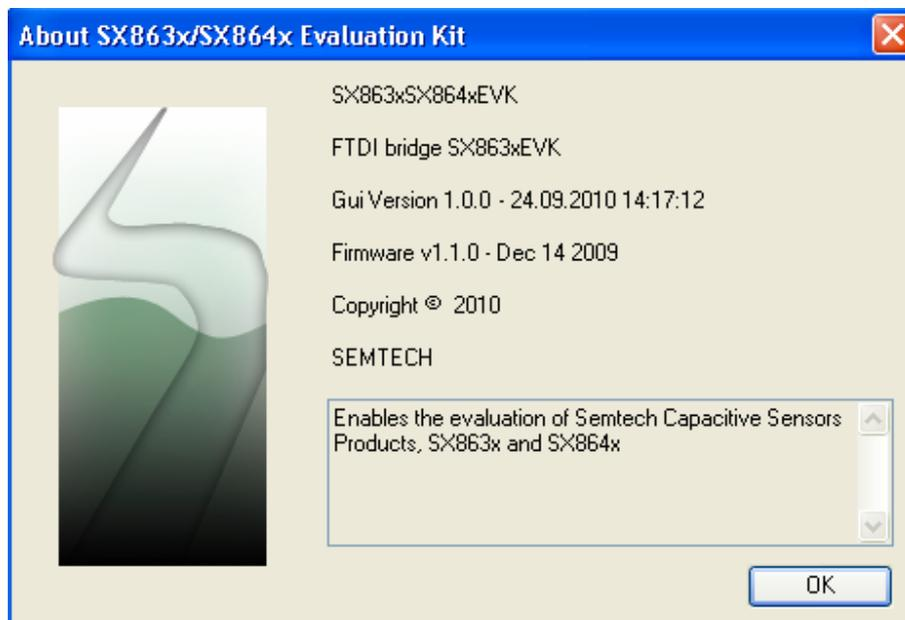

Figure 34: About window

5.5 Toolbar

The toolbar allows the user to choose rapidly an action without browsing through the file, action and help menu. The description of the items can be found in the previous menu sections.

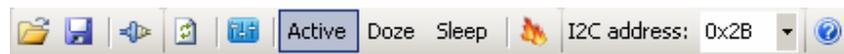

Figure 35: Toolbar

The I2C address is showing the address the GUI uses to communicate with the EVK (default address 0x2B). If a SX863x/4x with a different address is connected then the user can select the GUI address by typing directly the address value or by using the scroll bar.

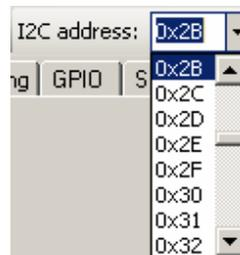

Figure 36: I2C address

5.6 Statusbar

The status bar shows useful information on the the status of the GUI and the EVK.



Figure 37: Statusbar

The **product** field shows the detected product on the EVK (SX8634, SX8635, SX8644 or SX8645).

The **SPM** field shows the origin of the SPM. This will be QSM, NVM1, NVM2 or NVM3.

The last two fields show the CRC of the SPM calculated by the GUI and if that CRC corresponds to the CRC of the EVK.

A green LED shows both CRCs are identical.

An orange LED shows that the CRCs are different. Clicking the 'refresh' item  will synchronize the GUI and the EVK and the LED will turn green.

The fields at the bottom of the Status bar show error messages or the actual name of the used SPM file. E.g. an error message will appear if the GUI tries to connect to an EVK which is not powered.



Figure 38: Statusbar with error message

In case the user opens or saves a SPM file then the current SPM file name appears at the right bottom side of the status bar.



Figure 39: Statusbar with SPM file

5.7 Sensor Status

The sensor status shows buttons and a slider for the SX8634/44EVK and buttons and a wheel for the SX8635/45EVK.

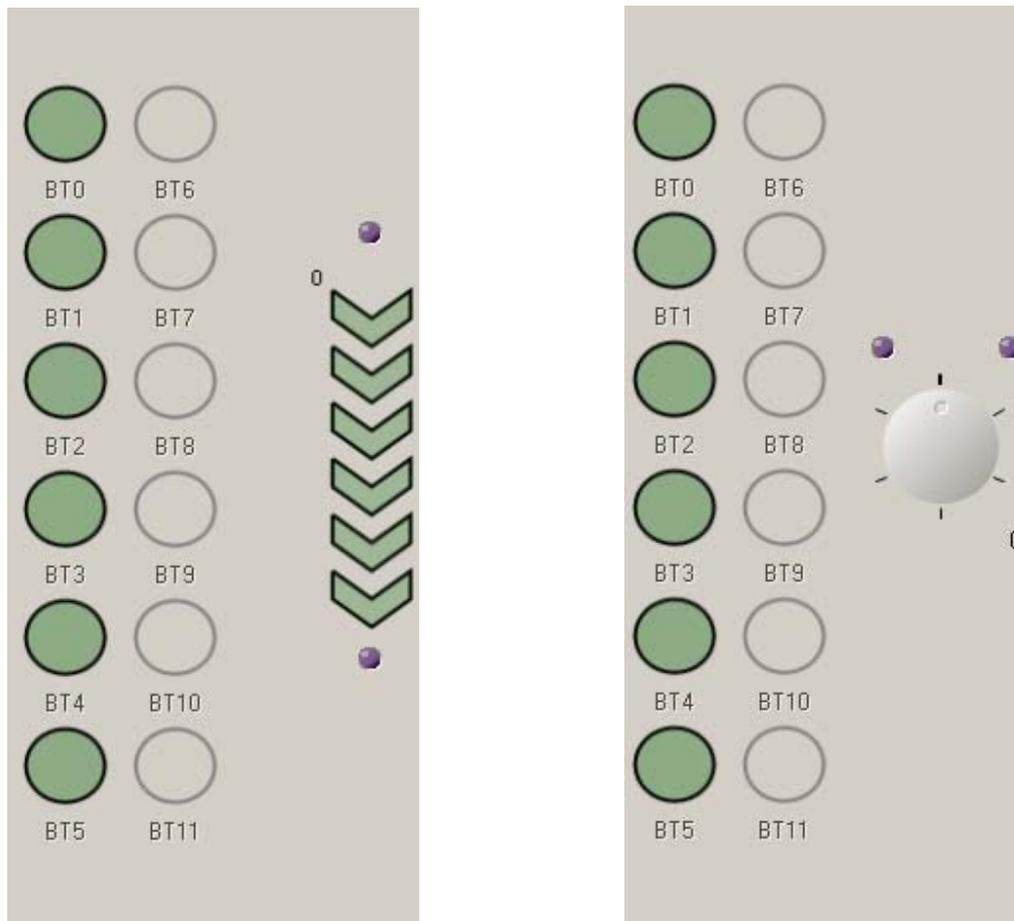

Figure 40: Sensor status for SX8634/44EVK and SX8635/45EVK

In the case of the SX8634/44 six green buttons are shown and six chevrons for the slider. In the case of the SX8635/45 six buttons are shown and the wheel is composed of six segments. The sensor status area will change according the number of buttons, sensors in a slider or wheel.

The sensor status is taken from the I2C registers of the SX8634/44 and SX8635/45. If the user touches a button strongly enough then the GUI turns the corresponding button into white.



Figure 41: Example BT0 and BT2 touched

If the slider is touched strongly enough then the position of the finger on the slider is shown by a small red bar and by the position value (position is 31 in the example below).
 If the slider is not touched the small red bar disappears while the GUI maintains the last touched position.



Figure 42: Example slider touched

Two purple indicators at the top and bottom of the slider show the move high or move low information taken from the I2C registers.
 Dark purple means no move detected. Bright purple means a move high or move low is detected.

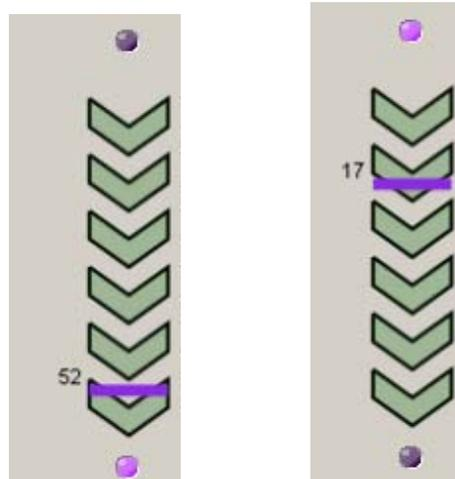

Figure 43: Example slider move high and move low

If the wheel is touched strongly enough then the position of the finger on the wheel is shown by a small red circle and by the position value (position is 39 in the example below). If the wheel is not touched the red circle turns into grey while the GUI maintains the last touched position.

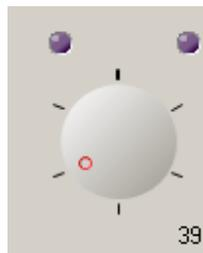

Figure 44: Example wheel touched

Two purple indicators at the top of the wheel show the move counter clock wise and move clock wise information taken from the I2C registers. Dark purple means no move detected. Bright purple means a move counter clock wise or clock wise is detected.

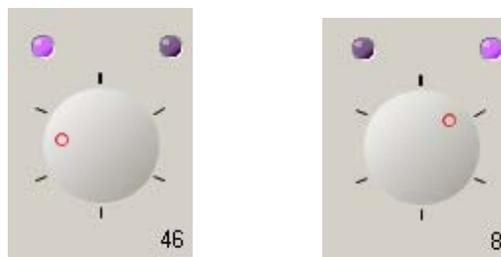

Figure 45: Example wheel move counter clock wise and move clock wise

5.8 GUI tabs

The GUI uses seven tabs:

- General
- Cap Sensors
- Buttons
- Slider/Wheel
- Mapping
- GPIO
- SPM/I2C

The content of the tabs allow the user to change the configuration of the SX863x/4x.

The tabs are organized according the sections of the SPM which are described in detail in the datasheets of the SX863x/4x family [1] to [13].

Each tab shows specific configuration data which can be changed by the user. The GUI assists the user by entering high level parameters so that it is not required to know the detailed hexadecimal information. Parameters will be grayed out if the user does not have to program them or if they do not apply.

In case the user prefers to enter direct hexadecimal data then this can be done in the SPM/I2C tab

5.8.1 General tab

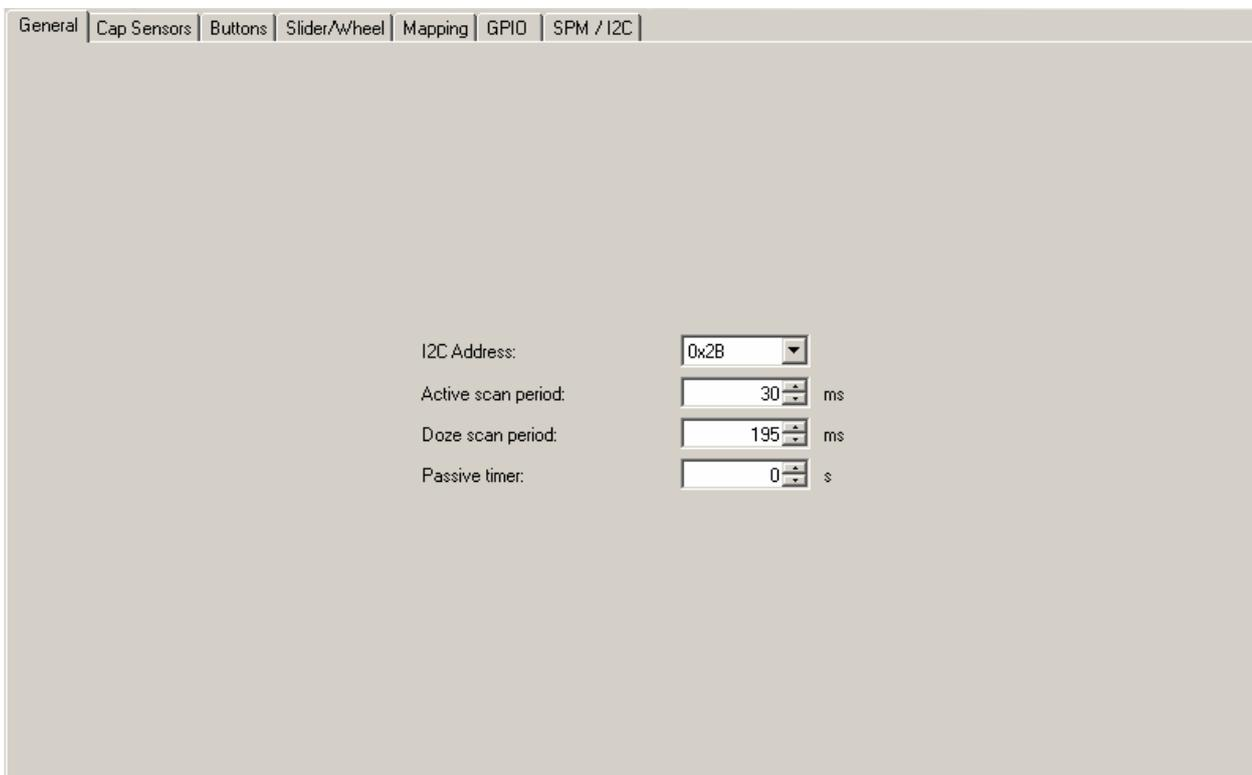

Figure 46: general tab

The general tab allows the user to change the system settings of the EVK.

5.8.2 Cap Sensors tab

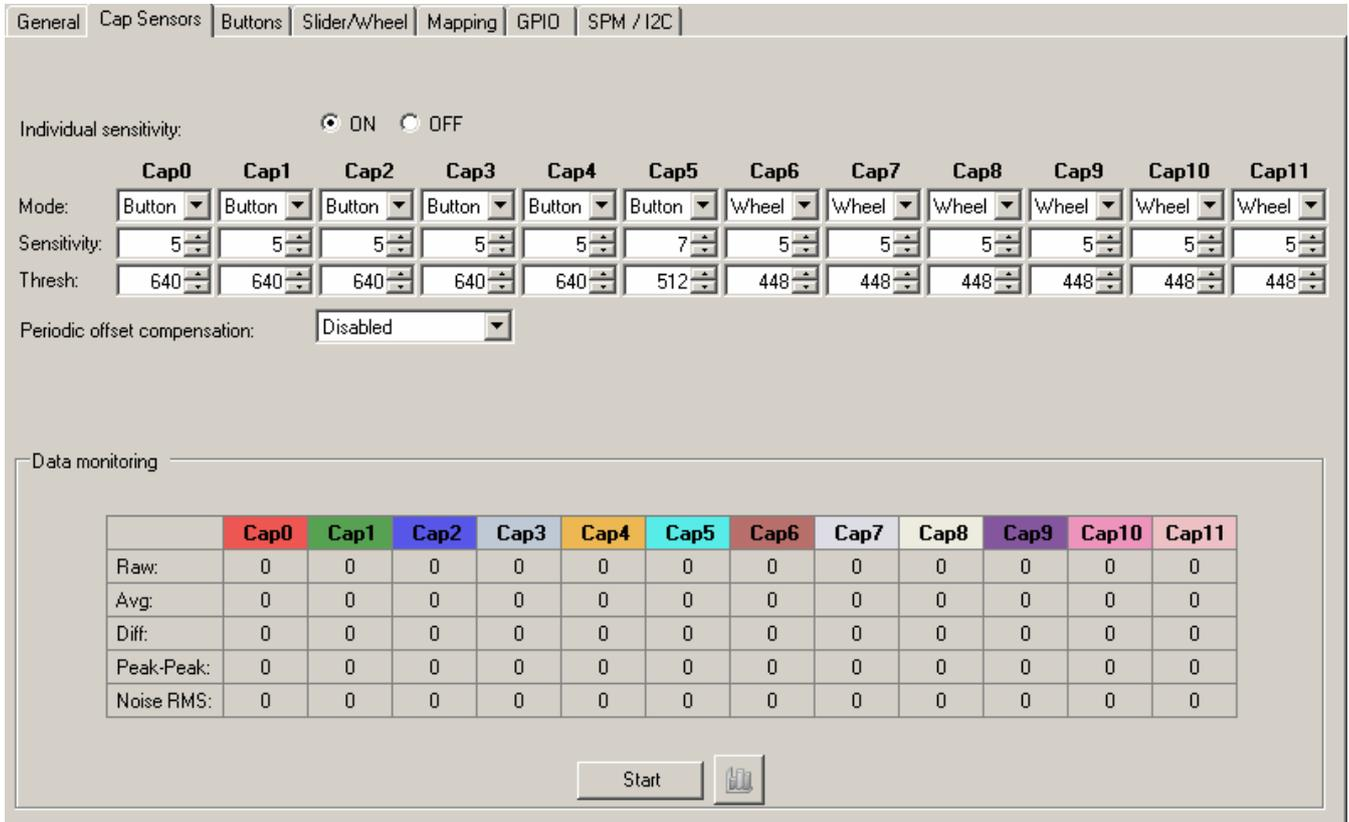

Figure 47: cap sensors tab

The top of the cap sensor tab is dedicated to the parameters associated to the sensors pins CAP0 to CAP11 of the SX863x/4x.

The bottom part of this tab allows the user to monitor noise estimators for each pin. The monitor is enabled by choosing the 'Start' button.

The small monitor icon will be enabled and the 'Start' button turns in to the 'Stop' button.

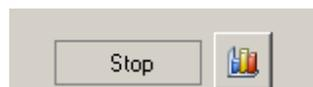

Figure 48: monitor enabled

In monitor mode the EVK is scanned every 195ms as the data rate over the USB is increased and the GUI needs to comply to this increased data throughput.

By clicking on the monitor icon the GUI opens the monitor window

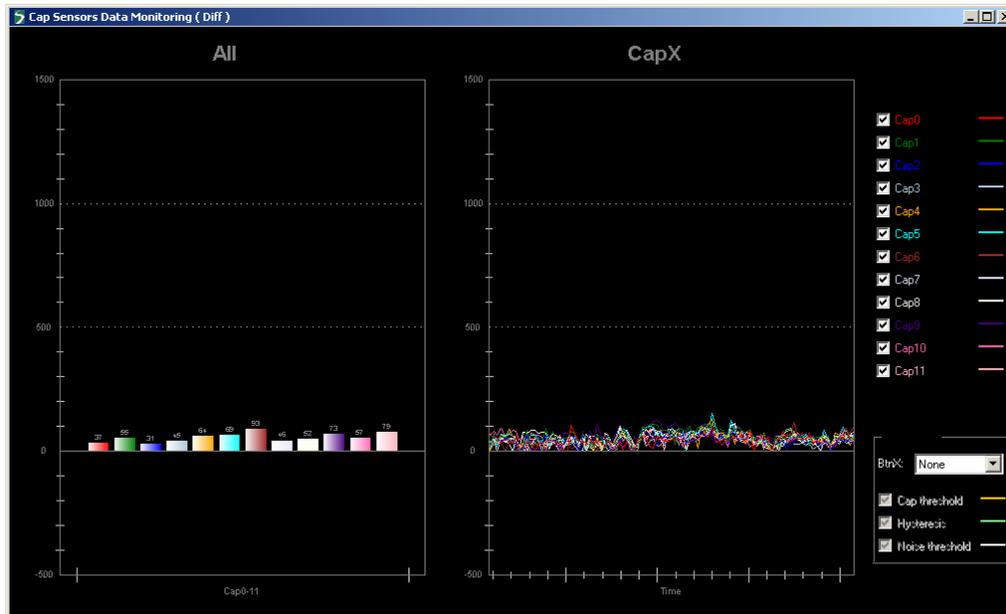

Figure 49:monitor window

The monitor window shows the cap sensor (difference) data (see datasheet for details). The left side of the window (graph header 'All') shows the current value of all enabled cap sensors. The right side of the window (graph header 'Capx') shows the values of all cap sensors over time.

At the very right side the user can hide or show signals by checking the boxes next to the Cap text.



Figure 50:show/hide monitor signals

ADVANCED COMMUNICATIONS & SENSING

Thresholds can be superposed on the graphs by selecting buttons, wheel or slider.

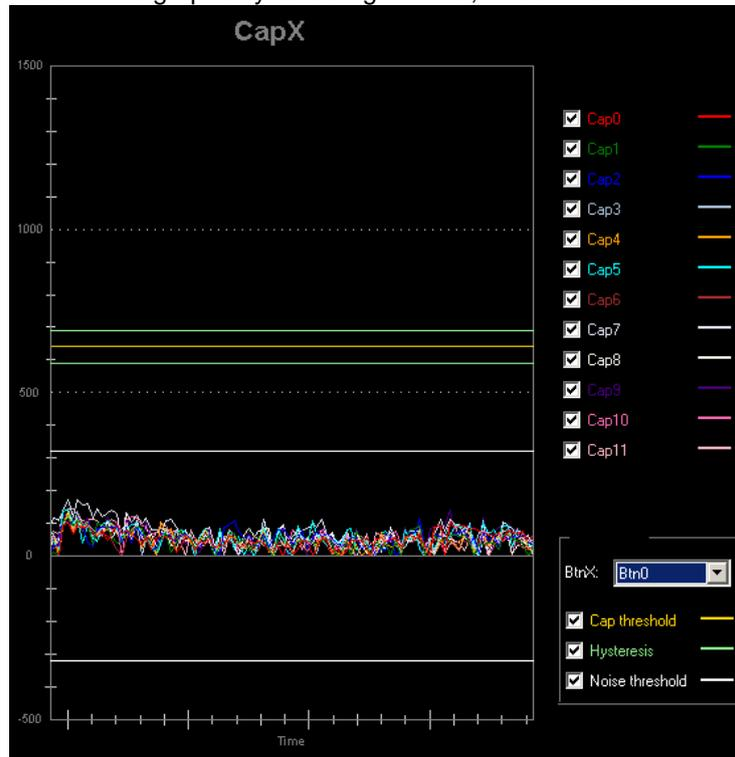

Figure 51: example: super pose thresholds of button 0

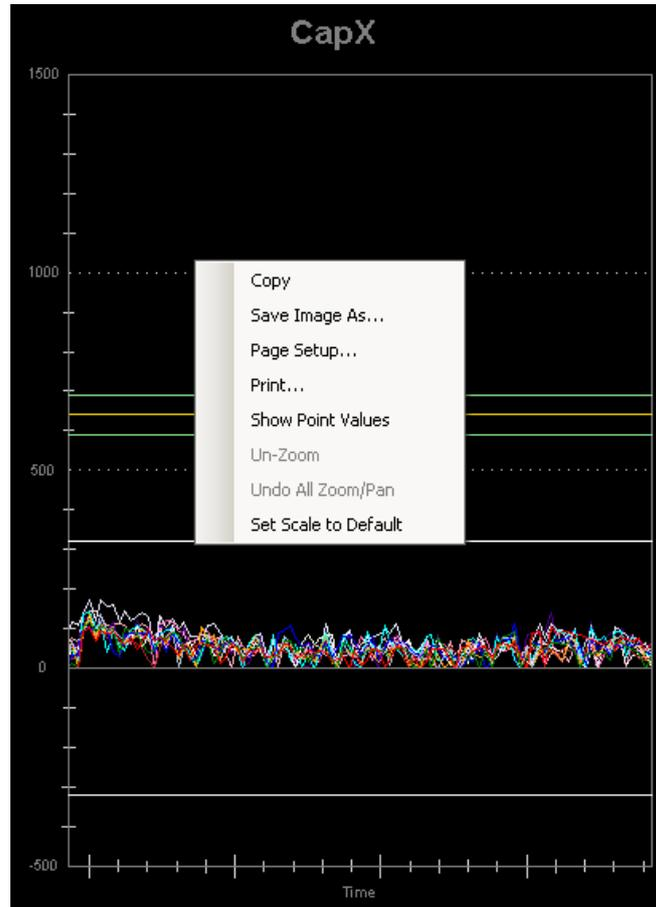

Figure 52:graph pop up window

By a right button mouse click on the graph a pop up window appears which allows the user to copy, save and print the graph. Furthermore the user can zoom or un-zoom into specific graph regions of interest.

5.8.3 Buttons tab

General	Cap Sensors	Buttons	Slider/Wheel	Mapping	GPIO	SPM / I2C
Touch report: <input type="text" value="ALL"/>						
Interrupt: <input type="text" value="On both"/>						
Release debounce: <input type="text" value="OFF"/> Samples						
Touch debounce: <input type="text" value="OFF"/> Samples						
Average threshold: <input type="text" value="320"/>						
Negative offset compensation threshold: <input type="text" value="320"/>						
Negative offset compensation trigger: <input type="text" value="1"/> Samples						
Hysteresis: <input type="text" value="10"/> %						
Stuck at timeout: <input type="text" value="0"/> s						

Figure 53: buttons tab

The buttons tab allows the user to change the configuration of the buttons.

5.8.4 Slider/Wheel tab

General	Cap Sensors	Buttons	Slider/Wheel	Mapping	GPIO	SPM / I2C
Release debounce: <input type="text" value="OFF"/> Samples						
Touch debounce: <input type="text" value="OFF"/> Samples						
Stuck at timeout: <input type="text" value="0"/> s						
Hysteresis: <input type="text" value="12"/>						
Normalization factor: <input type="text" value="10.00000"/>						
Average threshold: <input type="text" value="320"/>						
Negative offset compensation threshold: <input type="text" value="320"/>						
Negative offset compensation trigger: <input type="text" value="1"/> Samples						
Move detection Threshold: <input type="text" value="5"/> %						
Wheel angle offset: <input type="text" value="0"/> Steps						

Figure 54 slider or wheel tab

The slider or wheel tab allows the user to change the configuration of the slider (SX8634/44EVK) or the wheel (SX8635/45EVK).

5.8.5 Mapping tab

General	Cap Sensors	Buttons	Slider/Wheel	Mapping	GPIO	SPM / I2C
---------	-------------	---------	--------------	---------	------	-----------

Wakeup						
Sequence	Key0	Key1	Key2	Key3	Key4	Key5
0	Btn0	Btn0	Btn0	Btn0	Btn0	Btn0

Autolight							
I07	I06	I05	I04	I03	I02	I01	I00
High/CW	Low/CCW	Btn5	Btn4	Btn3	Btn2	Btn1	Btn0

Group0				Group1			
Slider/Wheel ->	<input type="checkbox"/> Segment	<input type="checkbox"/> High/CW	<input type="checkbox"/> Low/CCW	Slider/Wheel ->	<input type="checkbox"/> Touch	<input type="checkbox"/> High/CW	<input type="checkbox"/> Low/CCW
<input type="checkbox"/> Btn11	<input type="checkbox"/> Btn10	<input type="checkbox"/> Btn9	<input type="checkbox"/> Btn8	<input type="checkbox"/> Btn11	<input type="checkbox"/> Btn10	<input type="checkbox"/> Btn9	<input type="checkbox"/> Btn8
<input type="checkbox"/> Btn7	<input type="checkbox"/> Btn6	<input type="checkbox"/> Btn5	<input type="checkbox"/> Btn4	<input type="checkbox"/> Btn7	<input type="checkbox"/> Btn6	<input type="checkbox"/> Btn5	<input type="checkbox"/> Btn4
<input type="checkbox"/> Btn3	<input type="checkbox"/> Btn2	<input type="checkbox"/> Btn1	<input type="checkbox"/> Btn0	<input type="checkbox"/> Btn3	<input type="checkbox"/> Btn2	<input type="checkbox"/> Btn1	<input type="checkbox"/> Btn0

Segment hysteresis: %

Figure 55 mapping tab

The mapping tab allows the user to change the configuration of the mapping.

ADVANCED COMMUNICATIONS & SENSING
5.8.6 GPIO tab

		I07	I06	I05	I04	I03	I02	I01	I00
SPM	Mode:	GPO	GPO	GPO	GPO	GPO	GPO	GPO	GPO
	State after powerup:	OFF	OFF	OFF	OFF	OFF	OFF	OFF	OFF
	Autolight:	ON	ON	ON	ON	ON	ON	ON	ON
	Polarity:	Inverted	Inverted	Inverted	Inverted	Inverted	Inverted	Inverted	Inverted
	ON intensity:	255	255	255	255	255	255	255	255
	OFF intensity:	0	0	0	0	0	0	0	0
	Function:	Log	Log	Log	Log	Log	Log	Log	Log
	Inc factor:	1	1	1	1	1	1	1	1
	Dec factor:	1	1	1	1	1	1	1	1
	Inc time:	OFF	OFF	OFF	OFF	OFF	OFF	OFF	OFF
	Dec time:	0.5 ms	0.5 ms	2.0 ms	2.0 ms	2.0 ms	2.0 ms	2.0 ms	2.0 ms
	OFF delay:	OFF	OFF	0.6 s	0.6 s	0.6 s	0.6 s	0.6 s	0.6 s
	Pullup/Pulldown:	Disabled	Disabled	Disabled	Disabled	Disabled	Disabled	Disabled	Disabled
	Interrupt:	None	None	None	None	None	None	None	None
	Debounce:	OFF	OFF	OFF	OFF	OFF	OFF	OFF	OFF
I2C	GPO control:	OFF	OFF	OFF	OFF	OFF	OFF	OFF	OFF
	GPI status:	<input type="checkbox"/>	<input type="checkbox"/>	<input type="checkbox"/>	<input type="checkbox"/>	<input type="checkbox"/>	<input type="checkbox"/>	<input type="checkbox"/>	<input type="checkbox"/>
	GPP intensity:	0	0	0	0	0	0	0	0

Figure 56 GPIO tab

The GPIO tab allows the user to change the configuration of the GPIO either through the SPM or through the I2C registers.

5.8.7 SPM/I2C tab

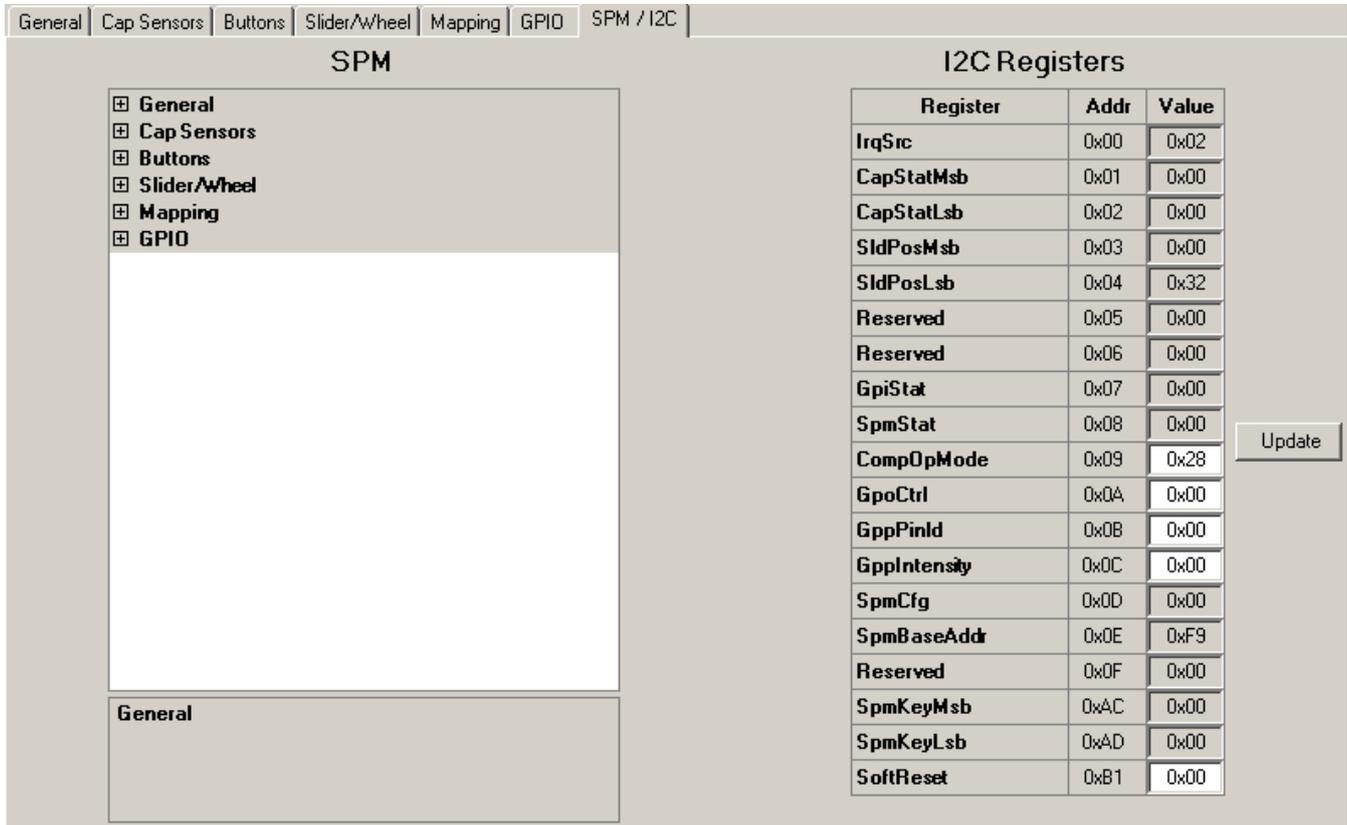

Register	Addr	Value
IrqSrc	0x00	0x02
CapStatMsb	0x01	0x00
CapStatLsb	0x02	0x00
SldPosMsb	0x03	0x00
SldPosLsb	0x04	0x32
Reserved	0x05	0x00
Reserved	0x06	0x00
GpiStat	0x07	0x00
SpmStat	0x08	0x00
CompOpMode	0x09	0x28
GpoCtrl	0x0A	0x00
GppPinId	0x0B	0x00
GppIntensity	0x0C	0x00
SpmCfg	0x0D	0x00
SpmBaseAddr	0x0E	0xF9
Reserved	0x0F	0x00
SpmKeyMsb	0xAC	0x00
SpmKeyLsb	0xAD	0x00
SoftReset	0xB1	0x00

Figure 57 SPM/I2C tab

The SPM/I2C tab allows the user to change the configuration on a lower level as the previous tabs.

The I2C registers can be directly written (white boxes). As soon as data is entered the data becomes red (indicating that the GUI is being updated but not yet the EVK) and is written to the EVK after the 'Enter' key (data becomes black again showing GUI and EVK are in sync).

The GUI reads the I2C registers at each interrupt from the EVK. A manual read/write of the I2C registers can be done by selecting the 'Update' button on the right side of this tab.

ADVANCED COMMUNICATIONS & SENSING

The SPM is shown in this tab as hexadecimal values. Experienced users can enter data here directly without passing through the previous described tabs.

The GUI assures that entering data in this tab or in the other tabs remain coherent.

The details of the SPM can be shown by expanding each separate line (click on the '+' box).

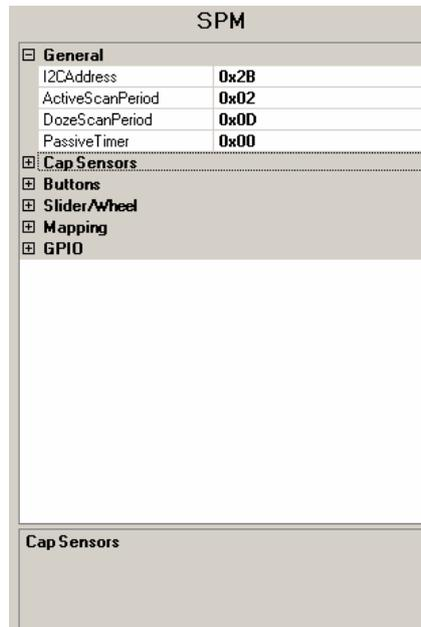

Figure 58 SPM expanding General

Hexadecimal values can be entered and will be written to the EVK immediately after the pushing the Enter key.

6 Schematics

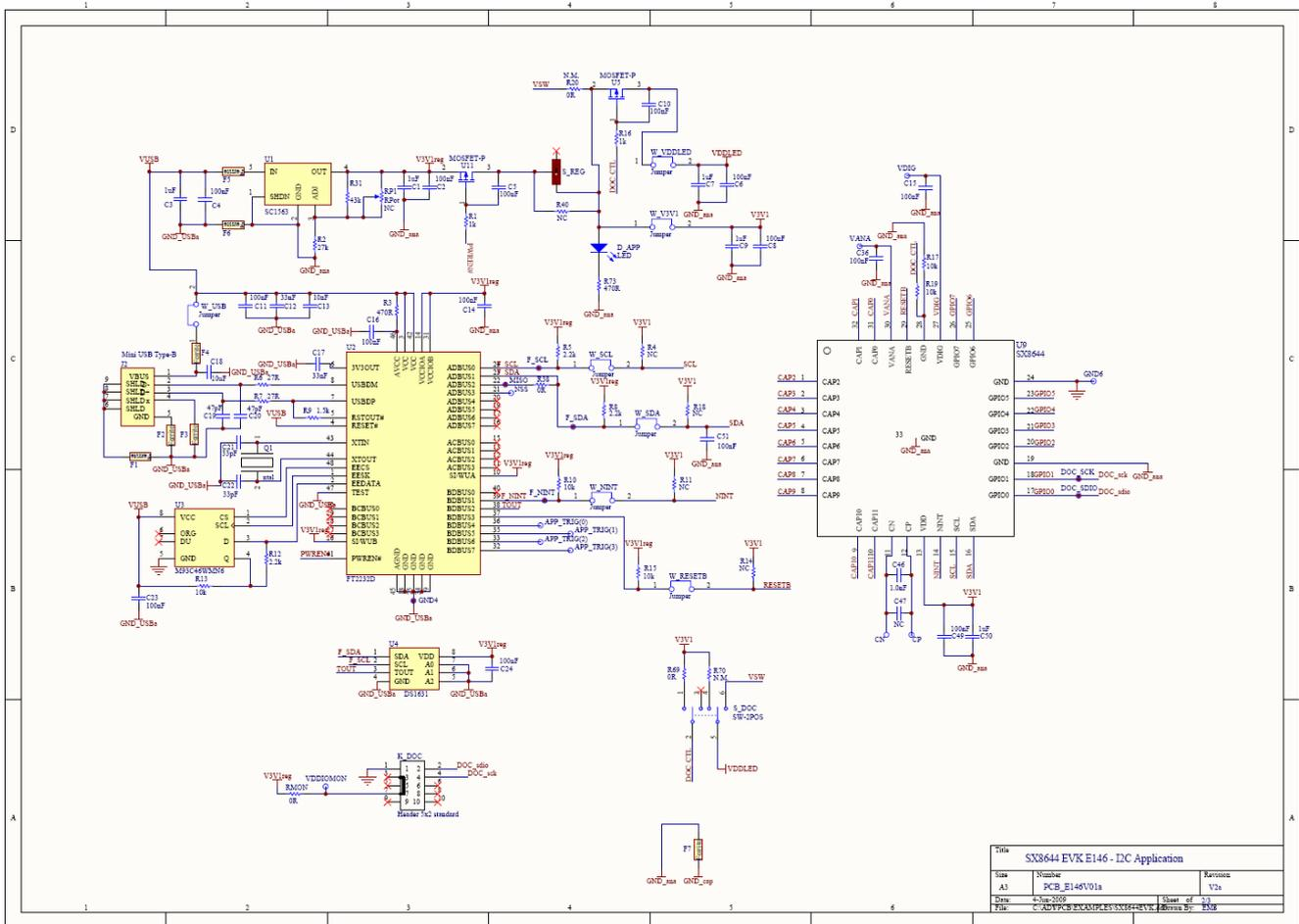

Figure 59: SX8644EVK schematic page 1/2

ADVANCED COMMUNICATIONS & SENSING

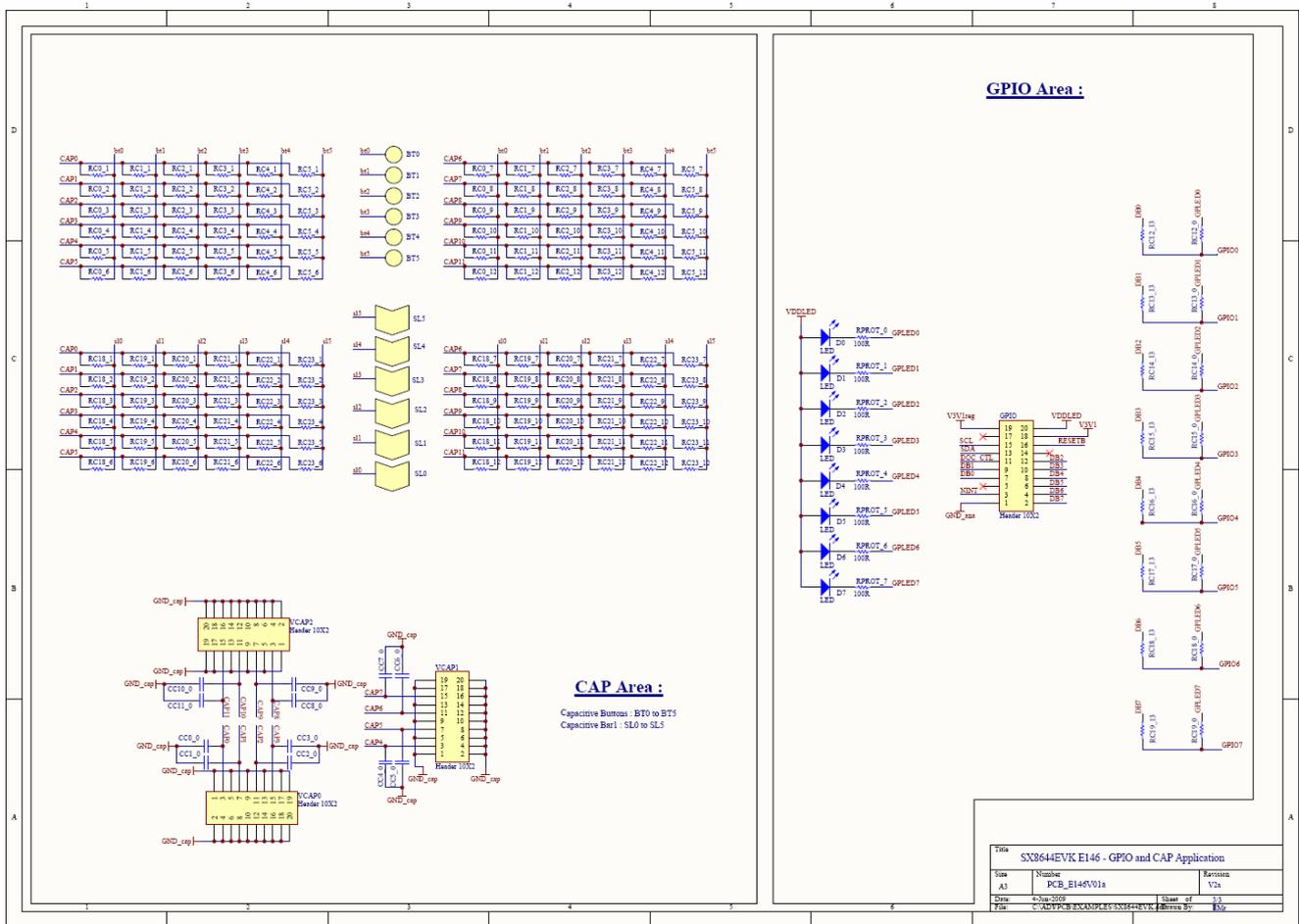

Figure 60: SX8644EVK schematic page 2/2

ADVANCED COMMUNICATIONS & SENSING

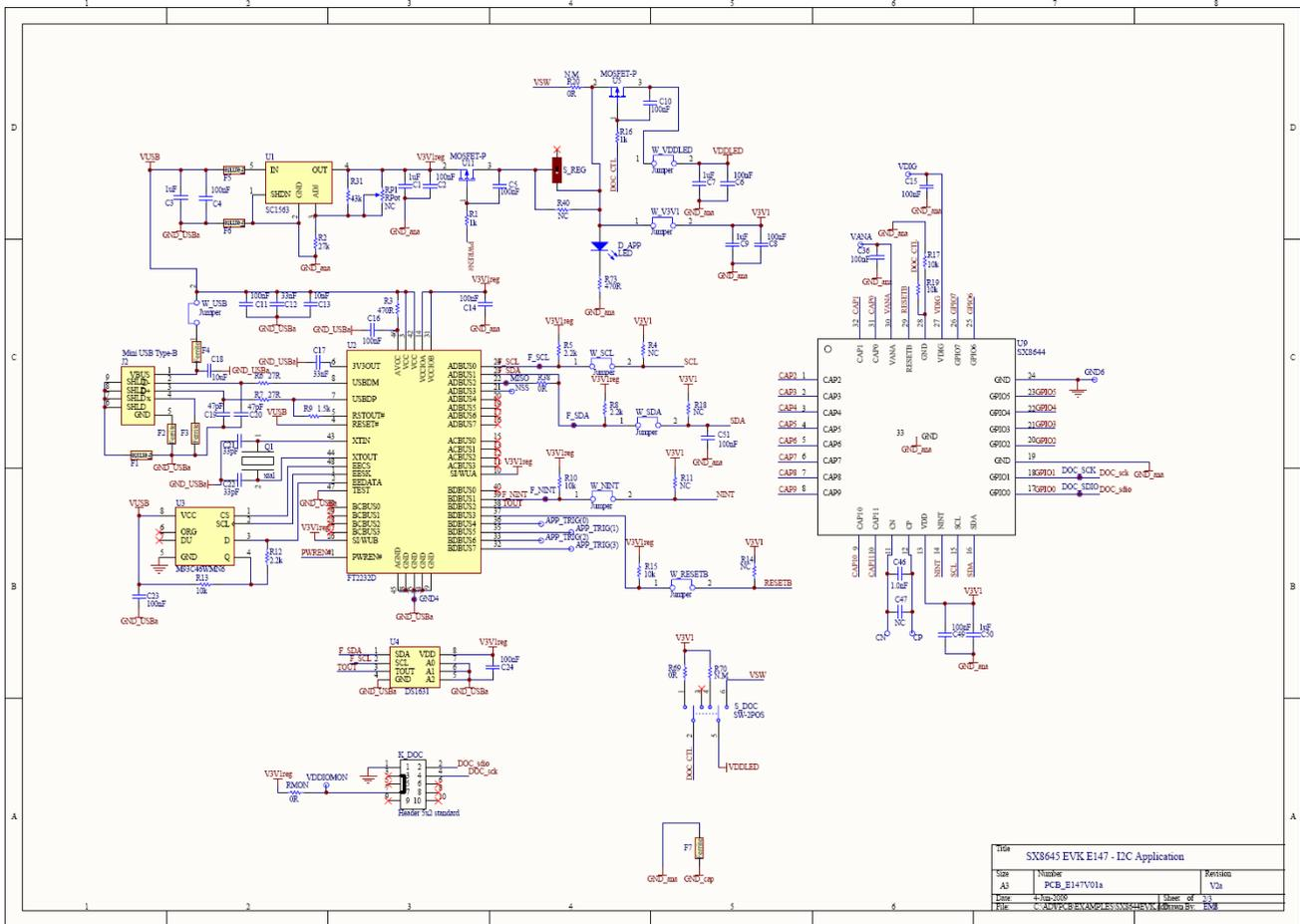

Figure 61: SX8645EVK schematic page 1/2

ADVANCED COMMUNICATIONS & SENSING

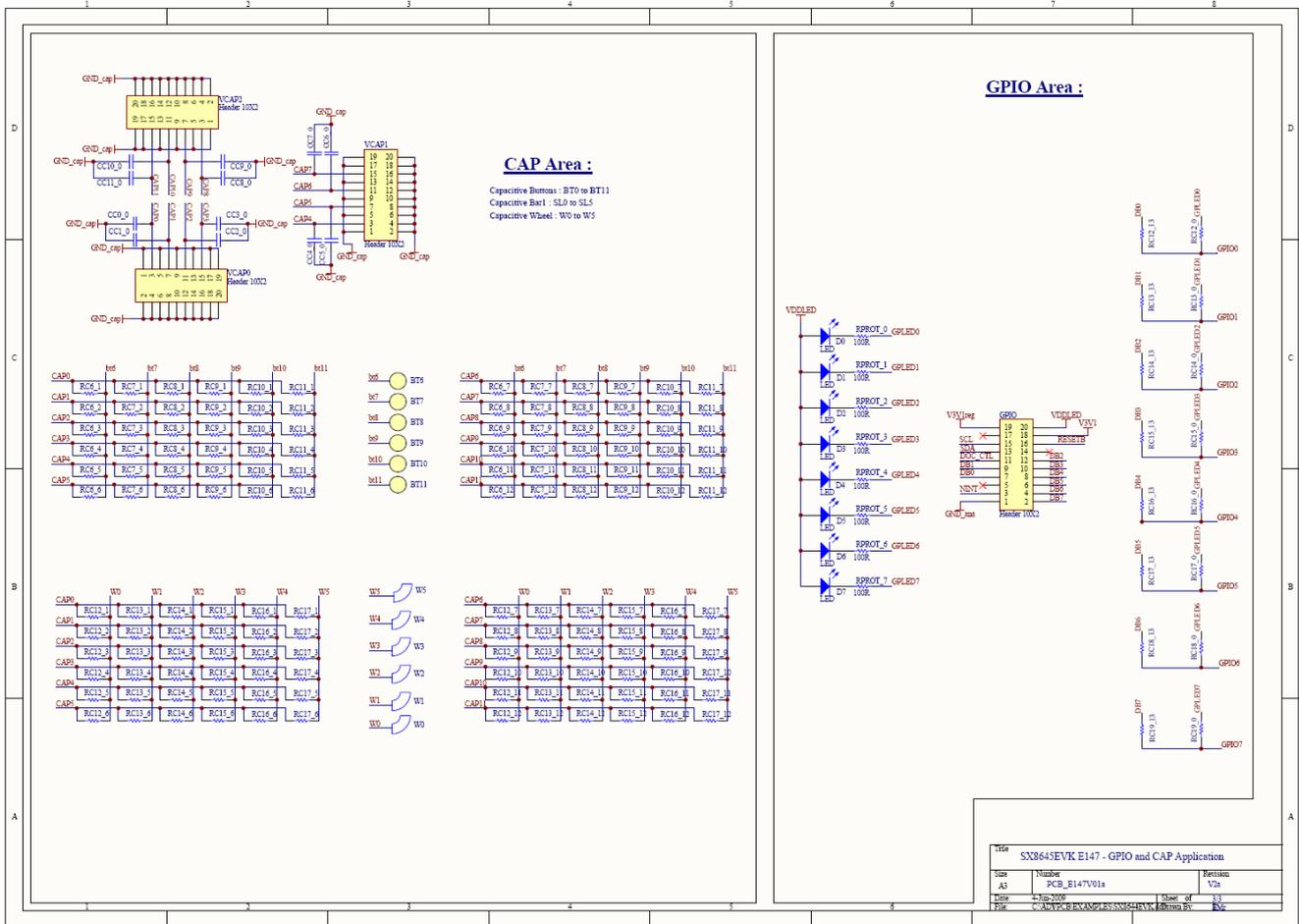

Figure 62: SX8645EVK schematic page 2/2

ADVANCED COMMUNICATIONS & SENSING

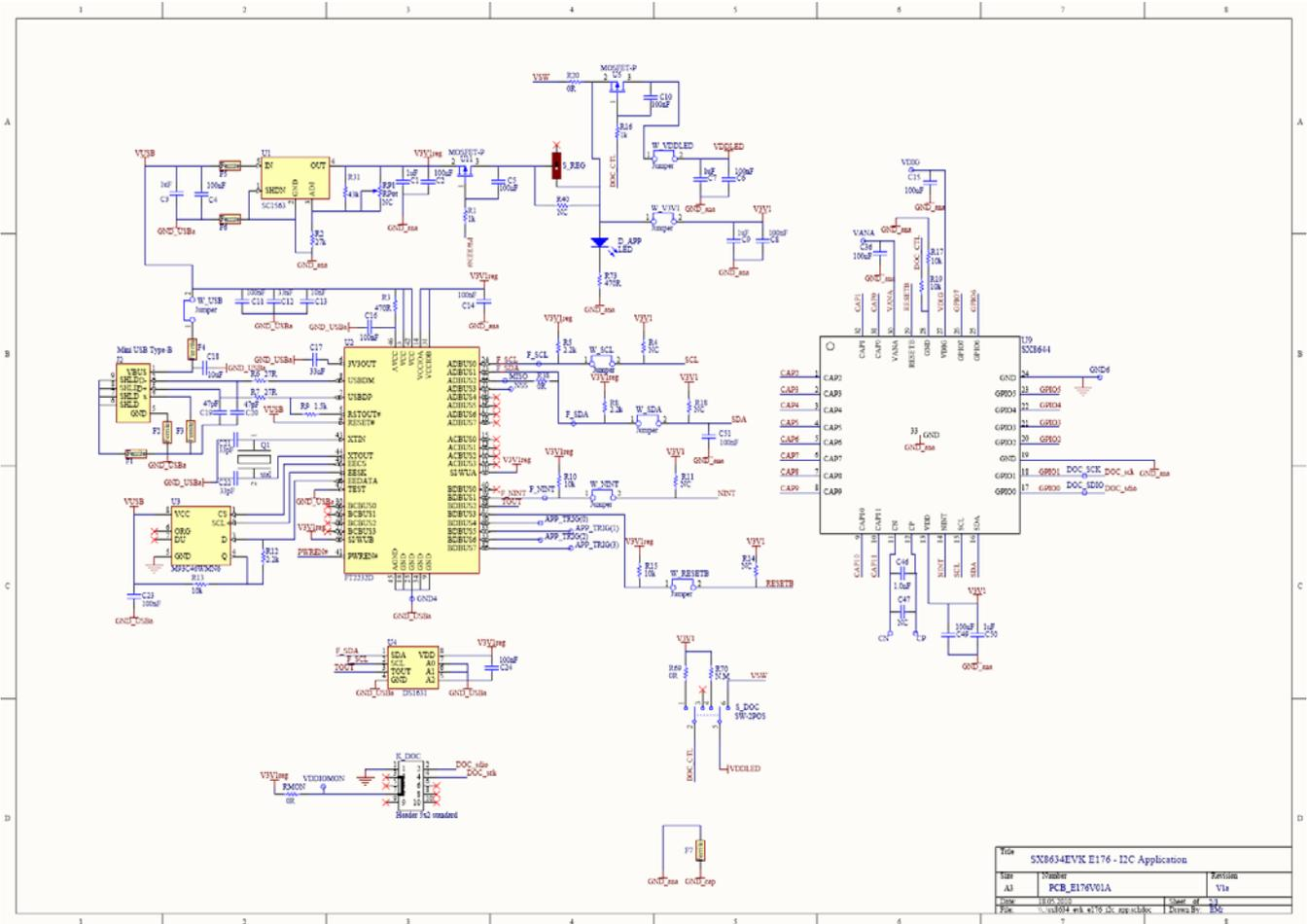

Figure 63: SX8634EVK schematic page 1/2

ADVANCED COMMUNICATIONS & SENSING

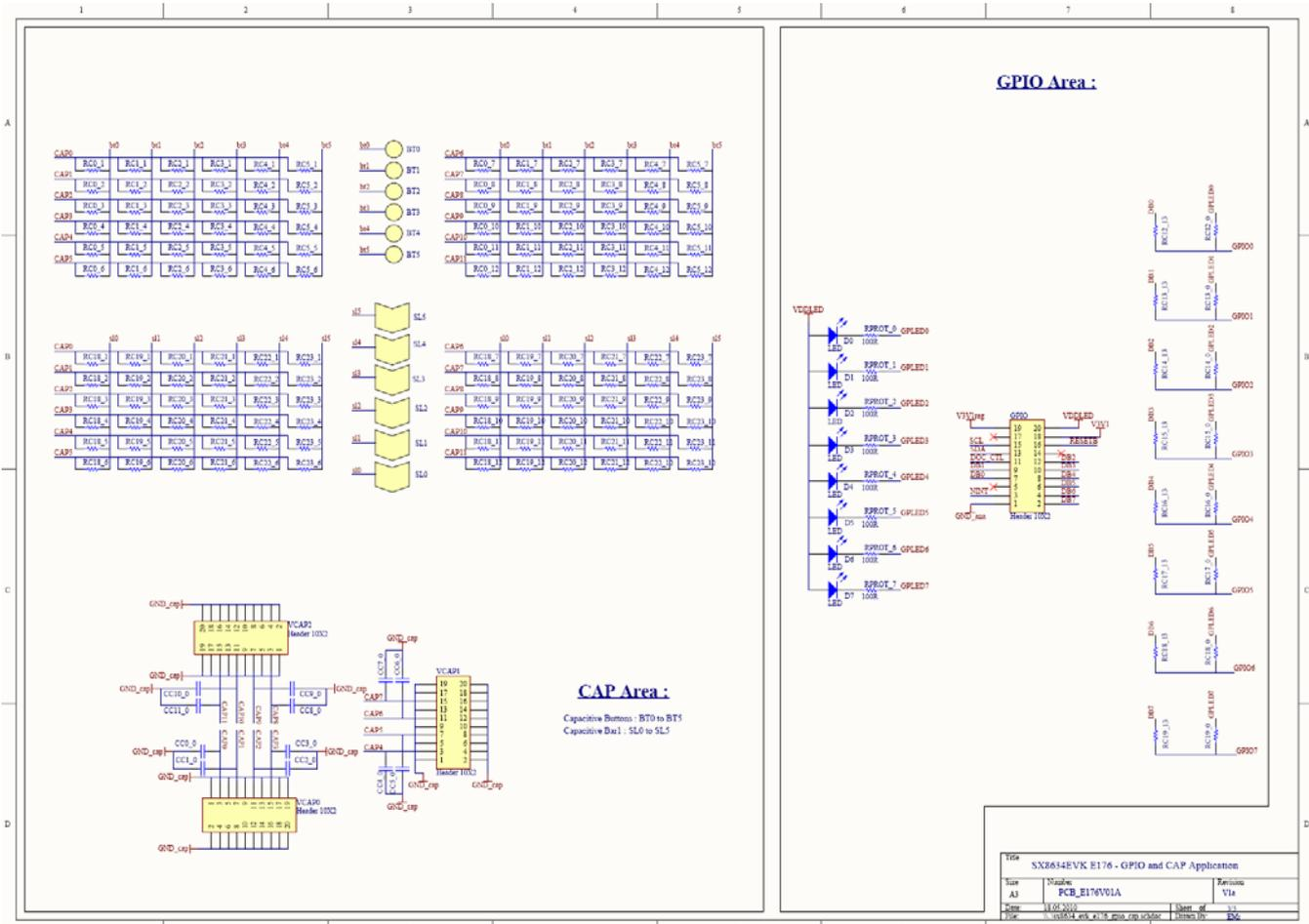

Figure 64: SX8634EVK schematic page 2/2

ADVANCED COMMUNICATIONS & SENSING

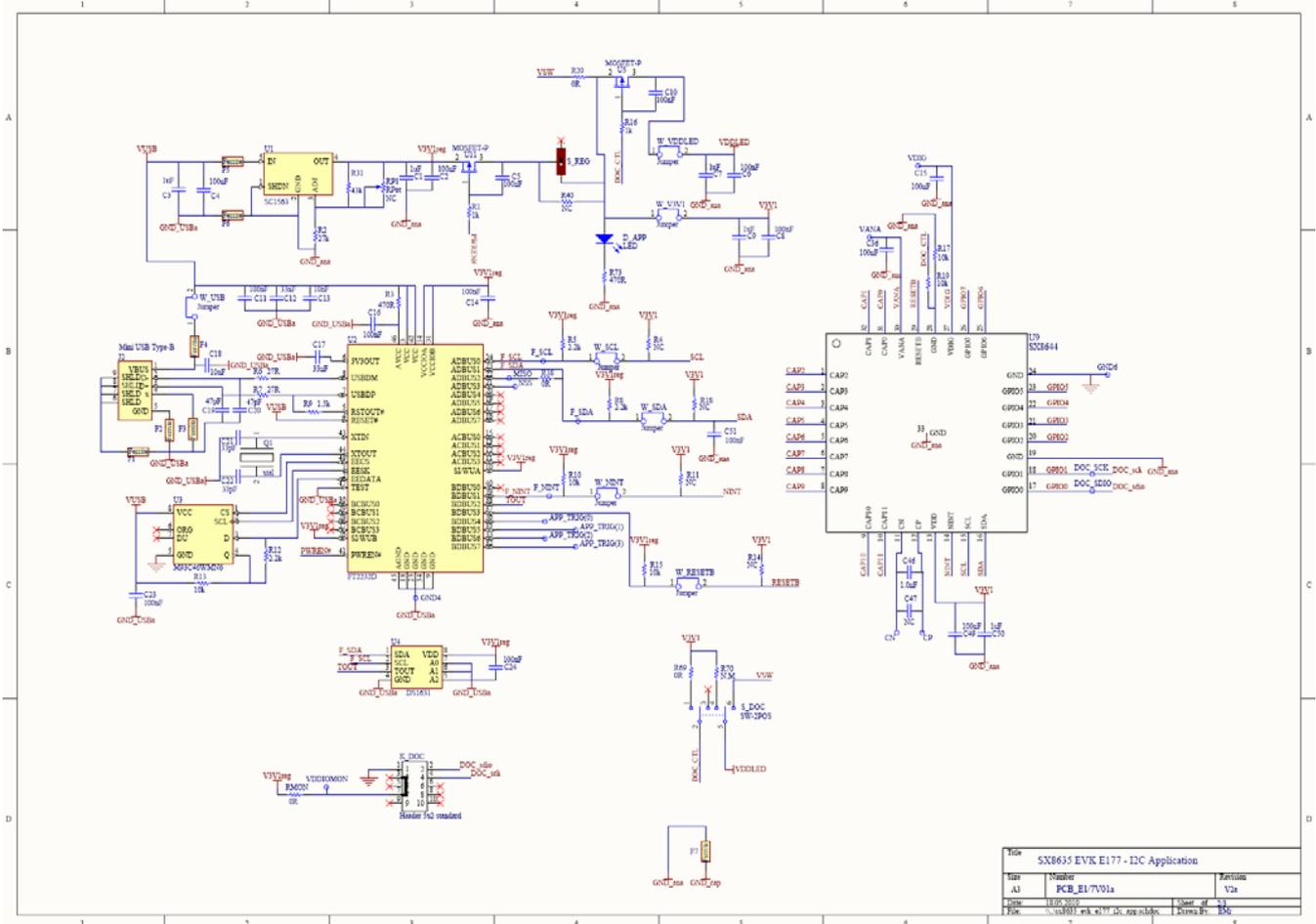

Figure 65: SX8635EVK schematic page 1/2

ADVANCED COMMUNICATIONS & SENSING

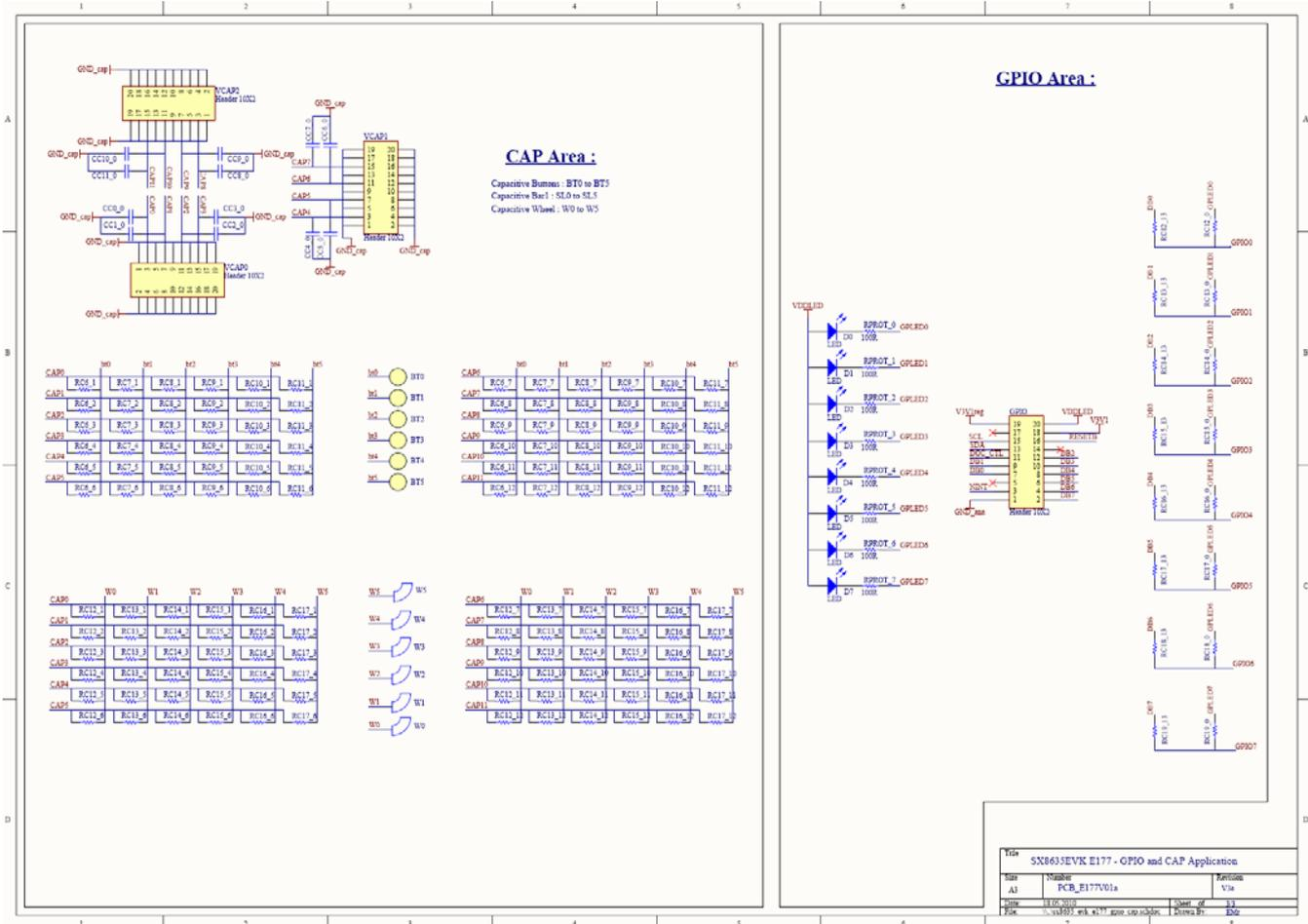

Figure 66: SX8635EVK schematic page 2/2

7 Layout

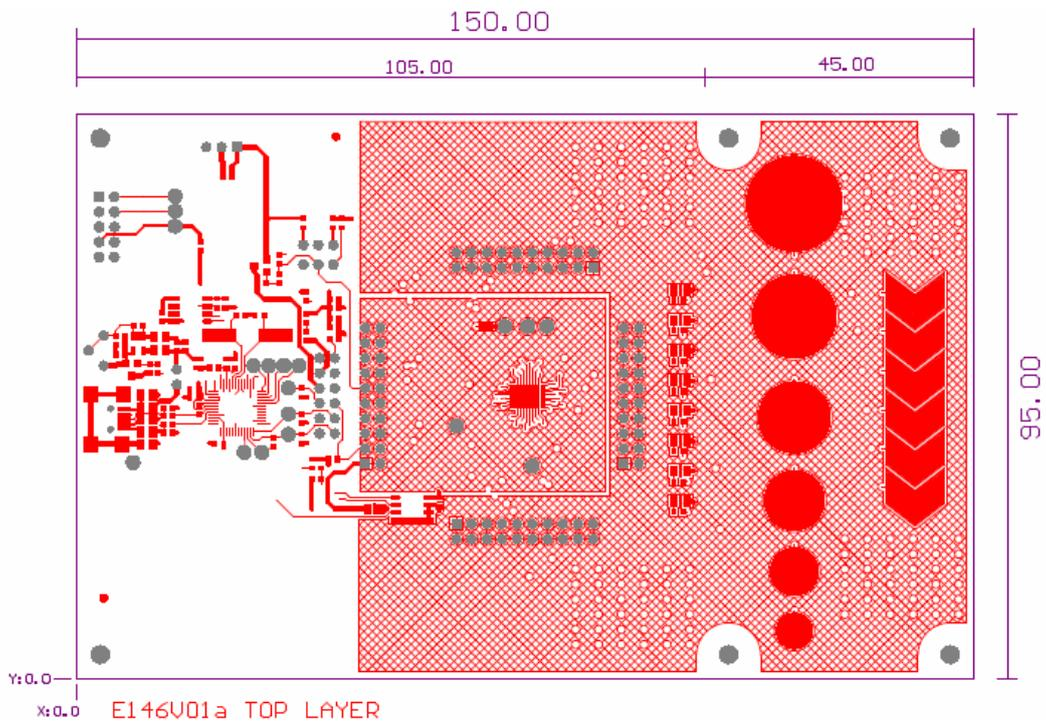

Figure 67: SX8644EVK top layer

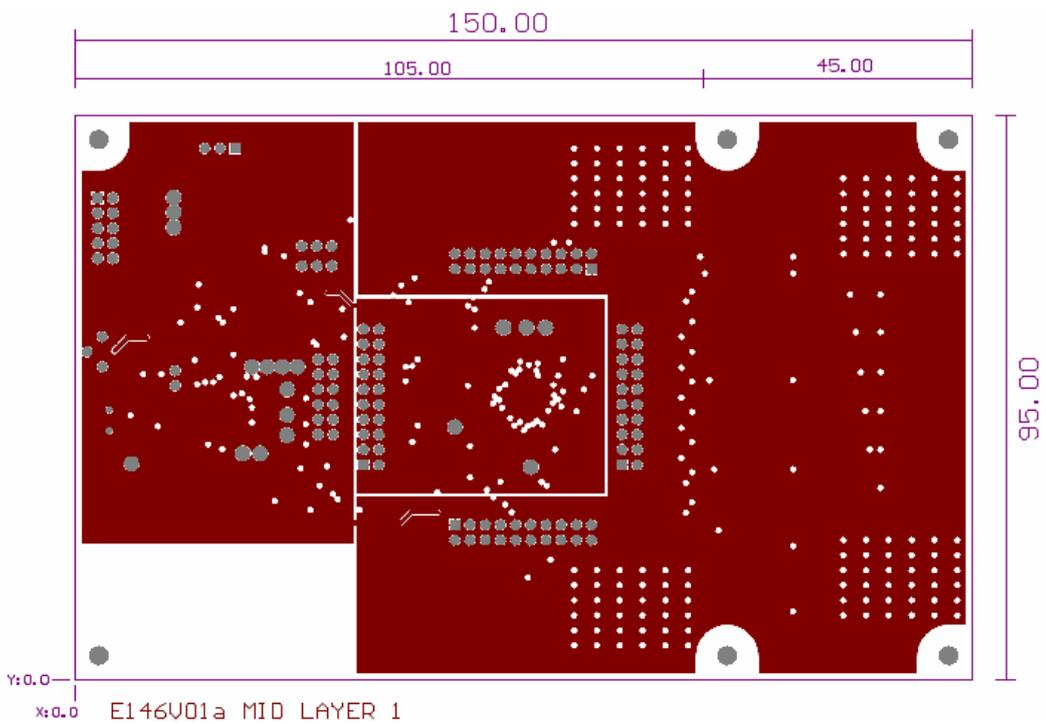

Figure 68: SX8644EVK mid layer 1

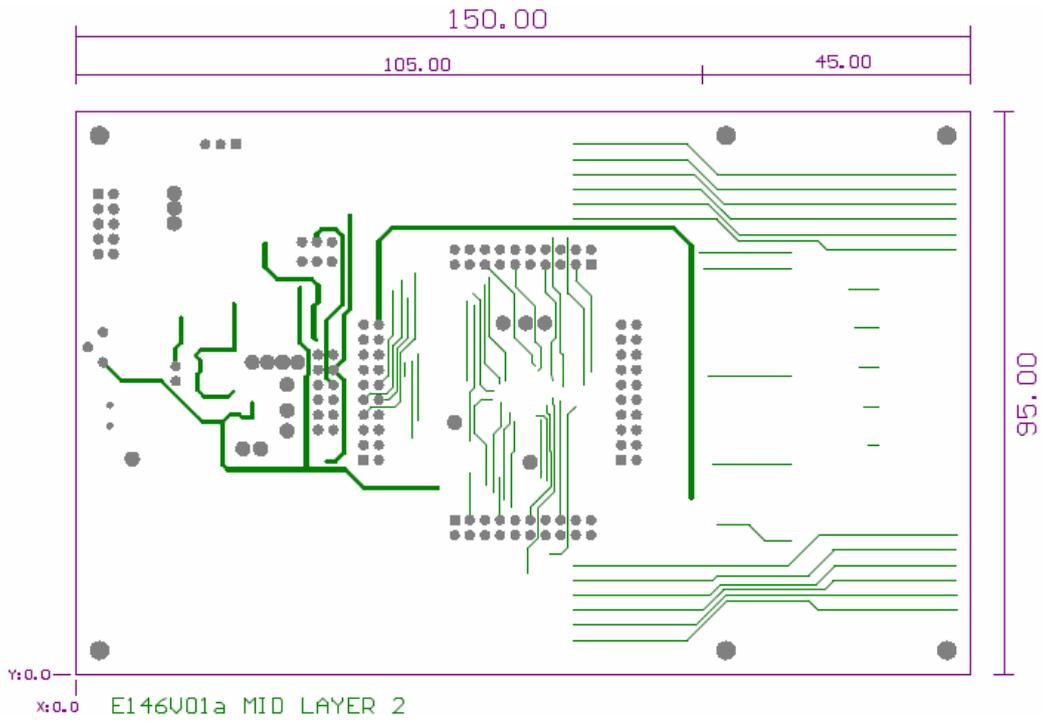

Figure 69: SX8644EVK mid layer 2

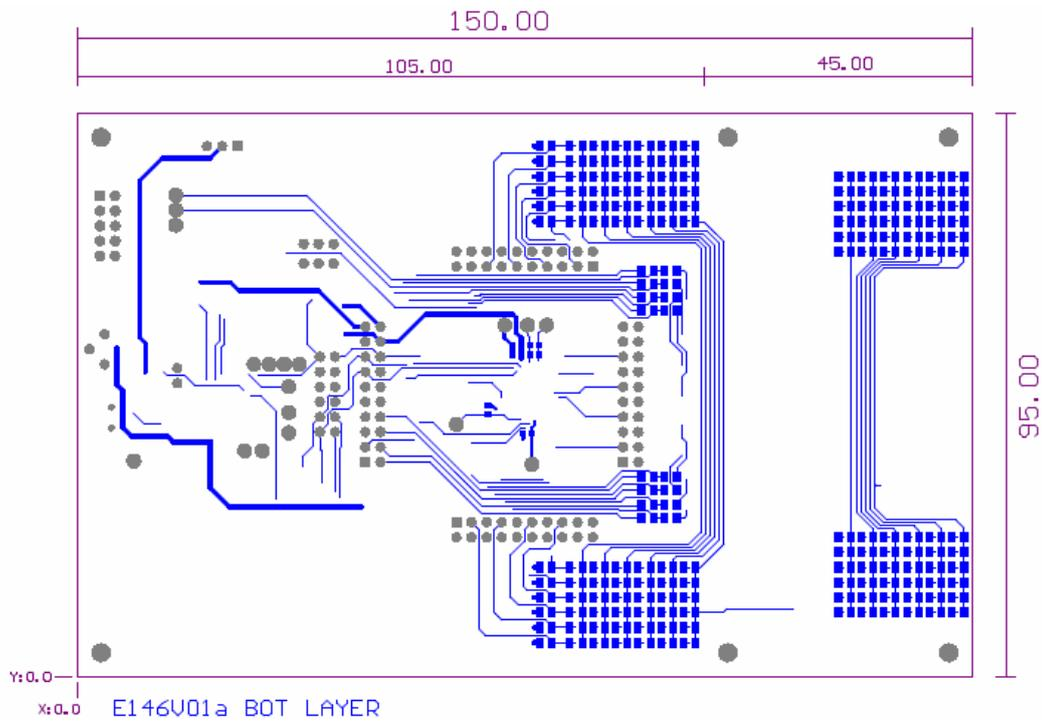

Figure 70: SX8644EVK bottom layer

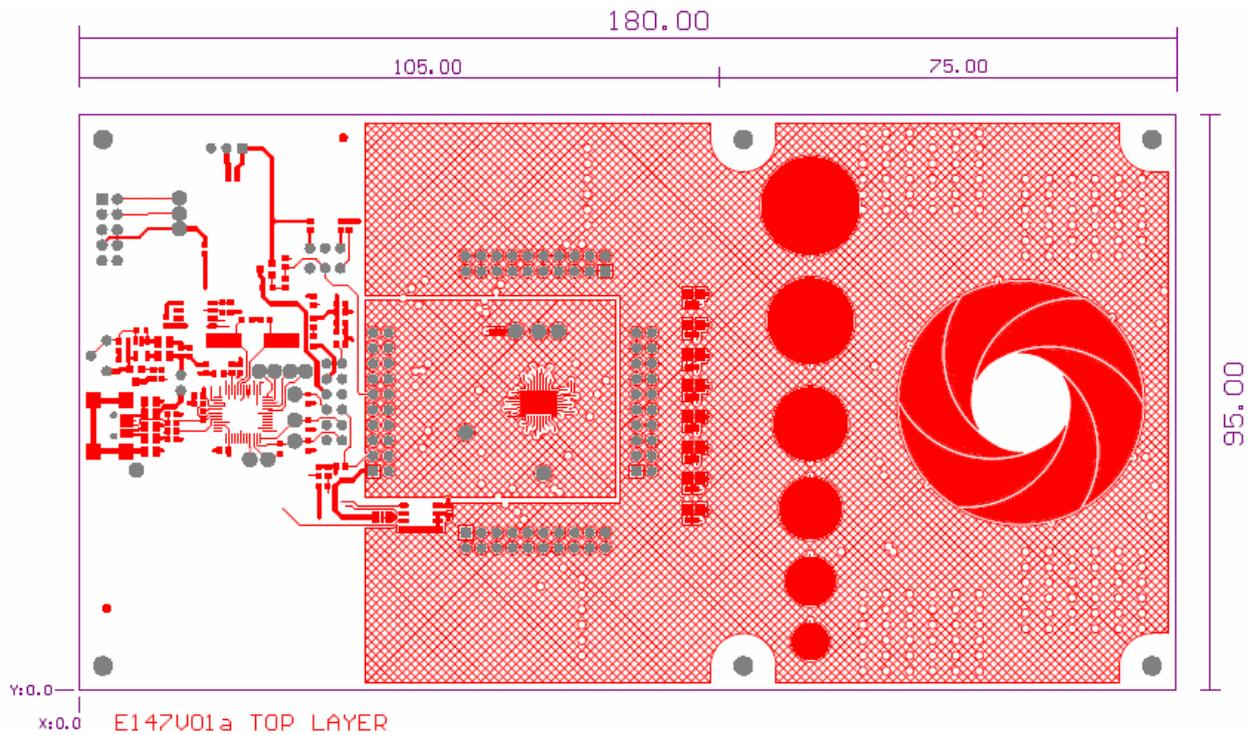

Figure 71: SX8645EVK top layer

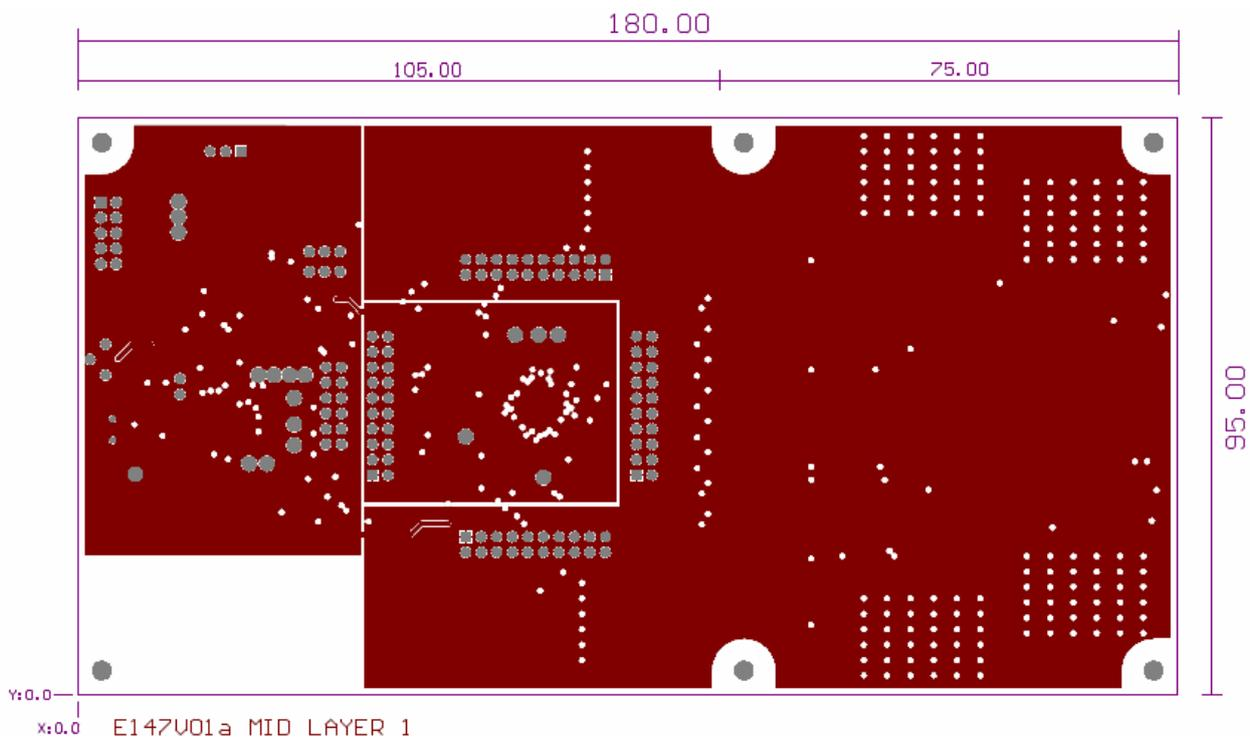

Figure 72: SX8645EVK mid layer 1

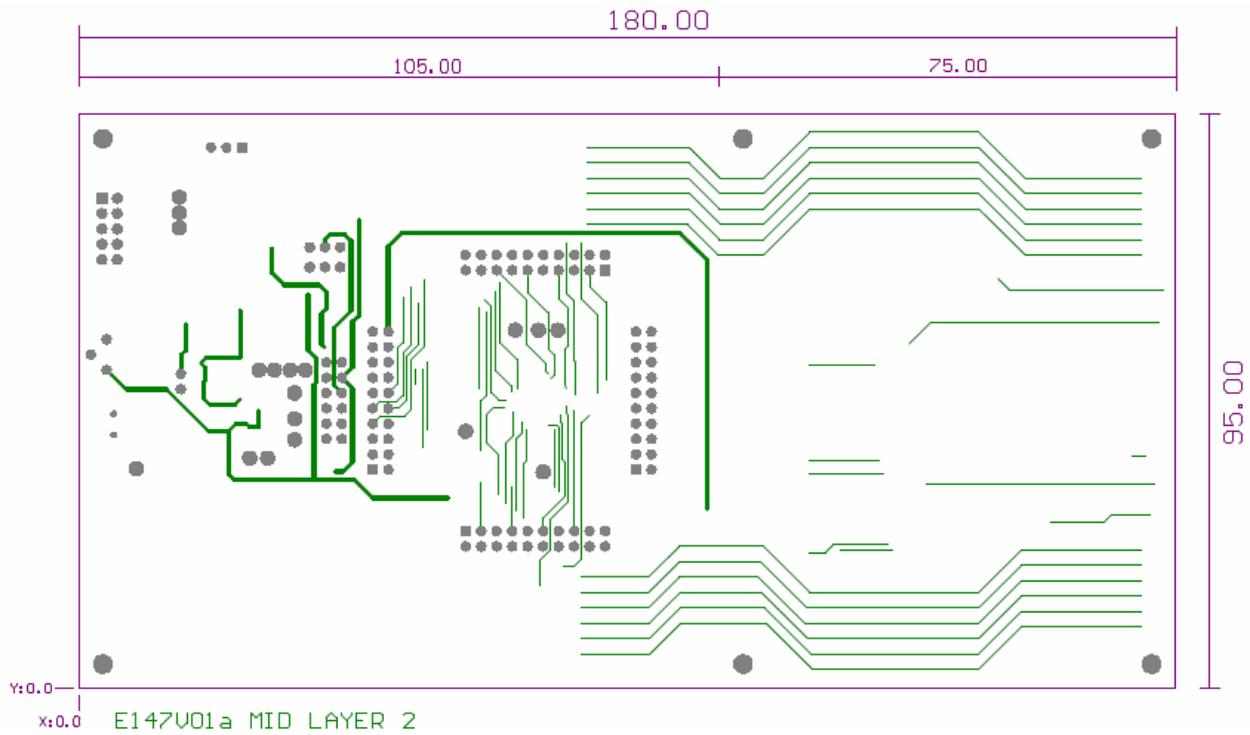

Figure 73: SX8645EVK mid layer 2

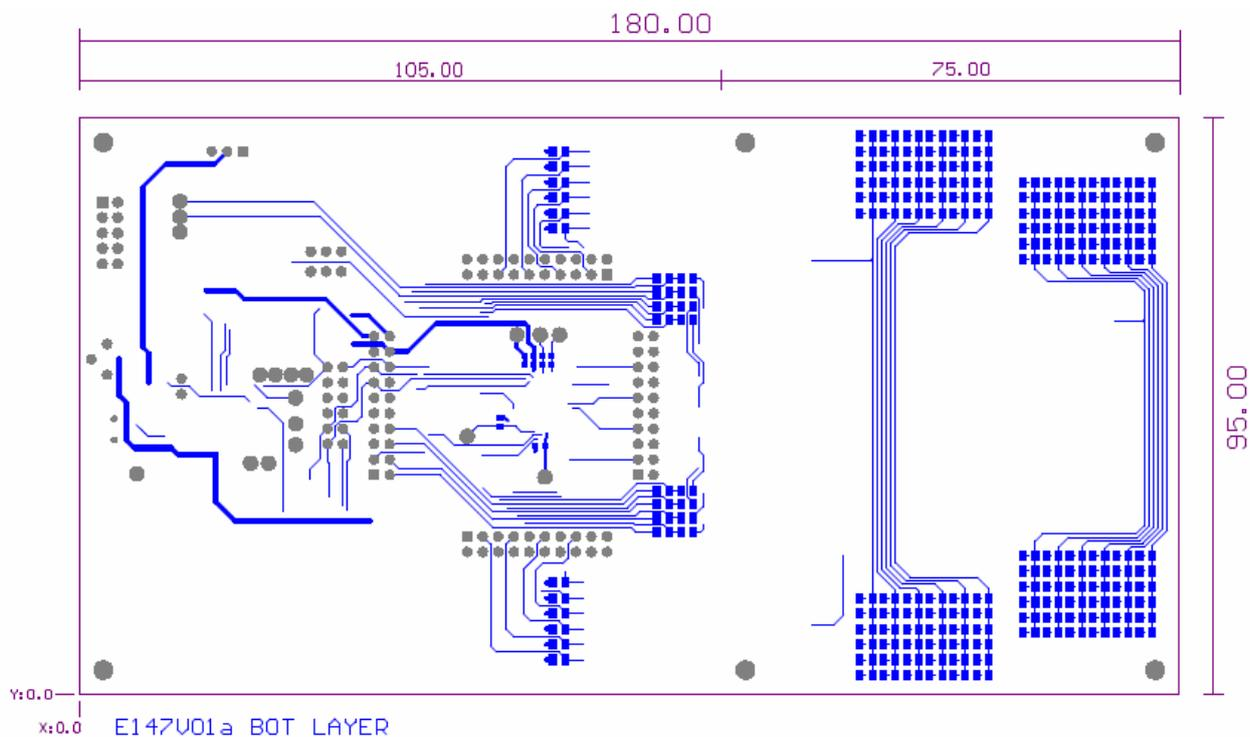

Figure 74: SX8645EVK bottom layer

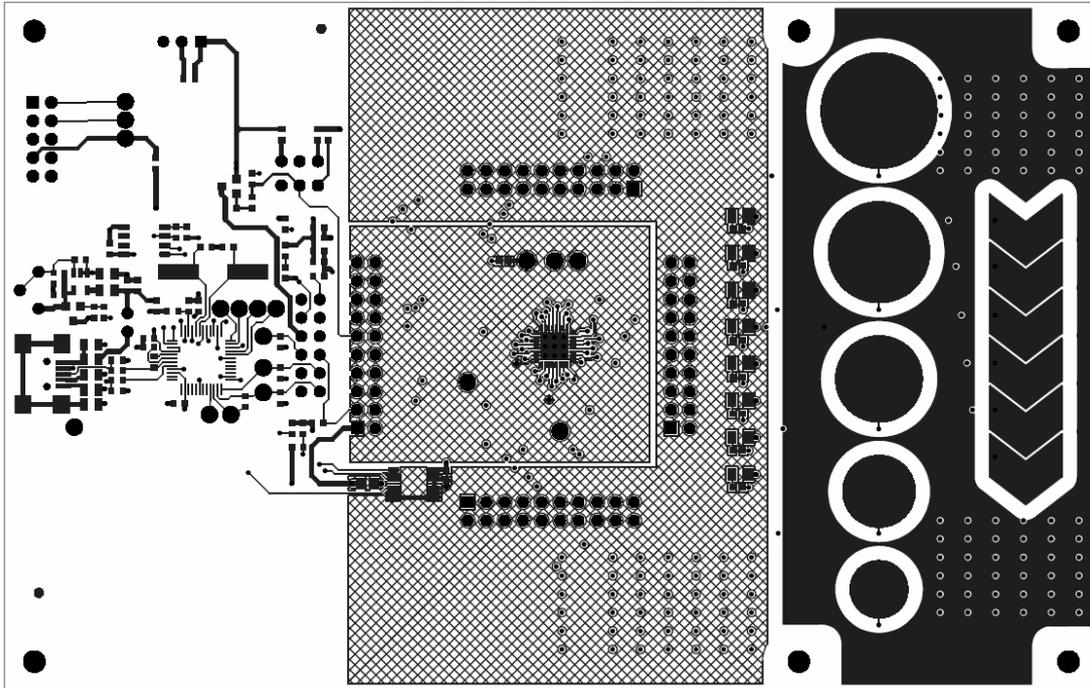

Figure 75: SX8634EVK top layer

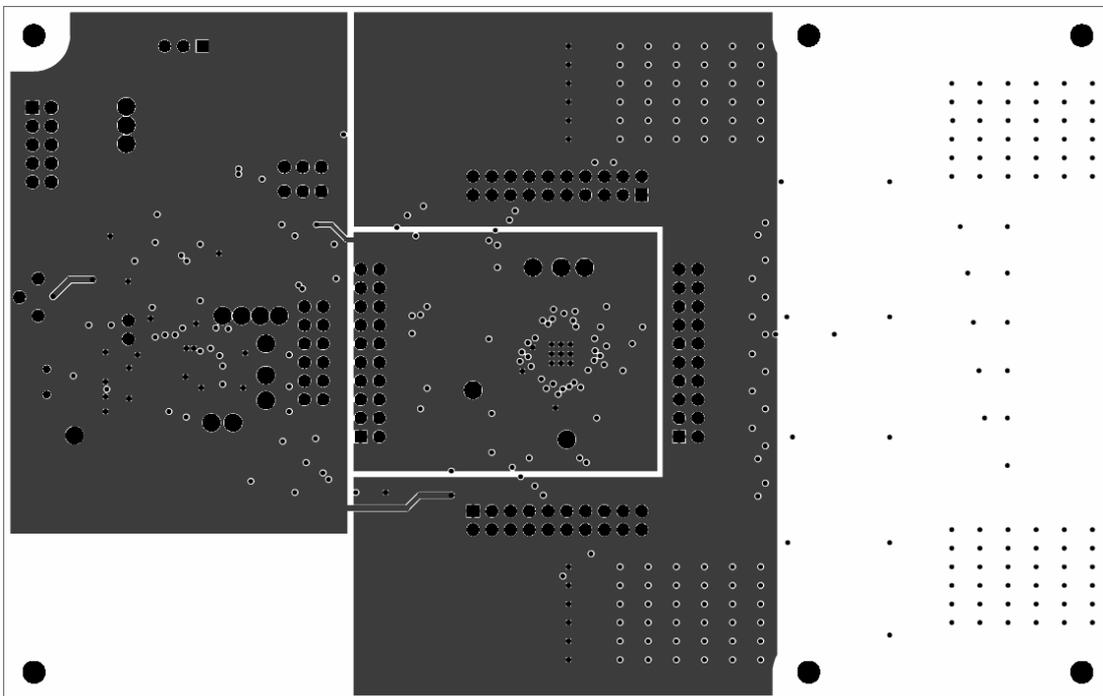

Figure 76: SX8634EVK mid layer 1

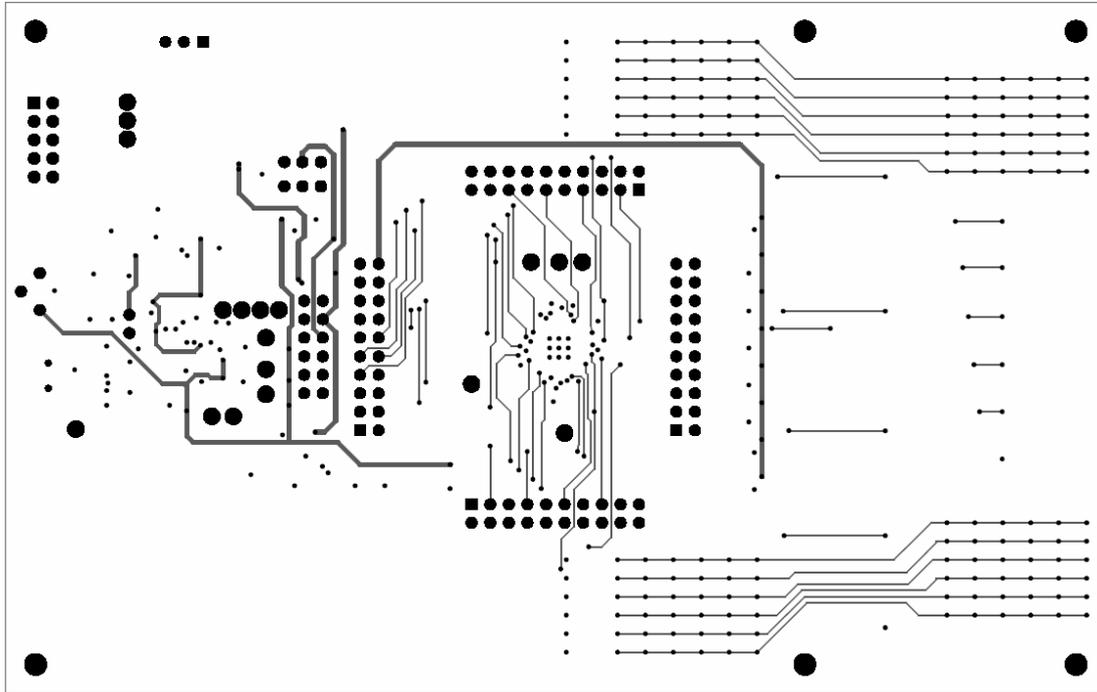

Figure 77: SX8634EVK mid layer 2

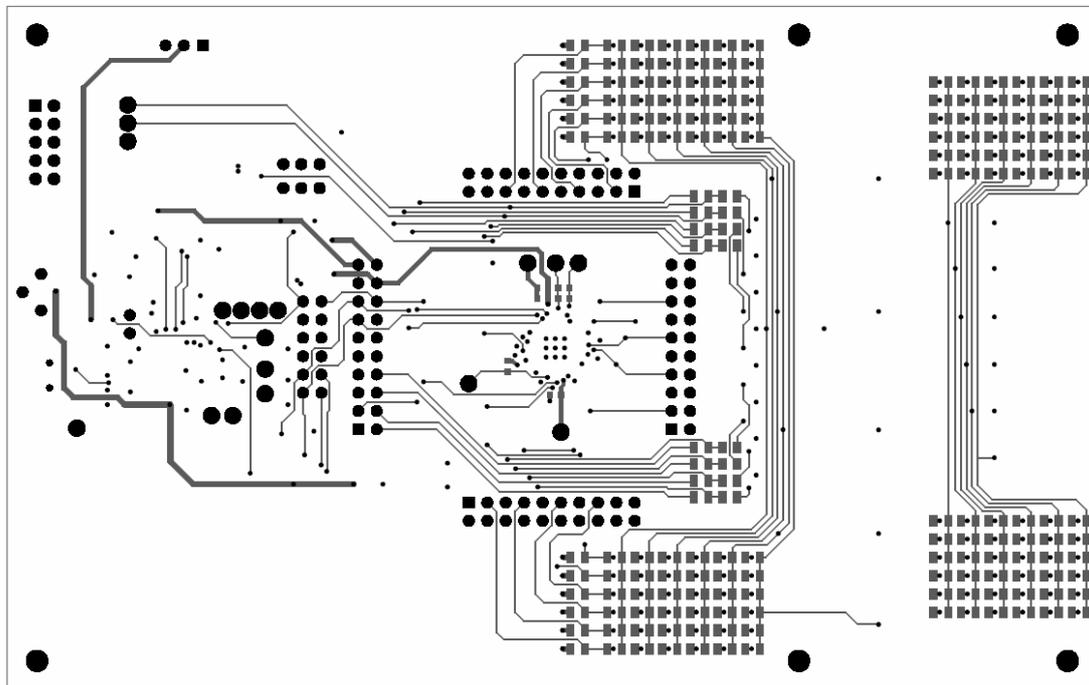

Figure 78: SX8634EVK bottom layer

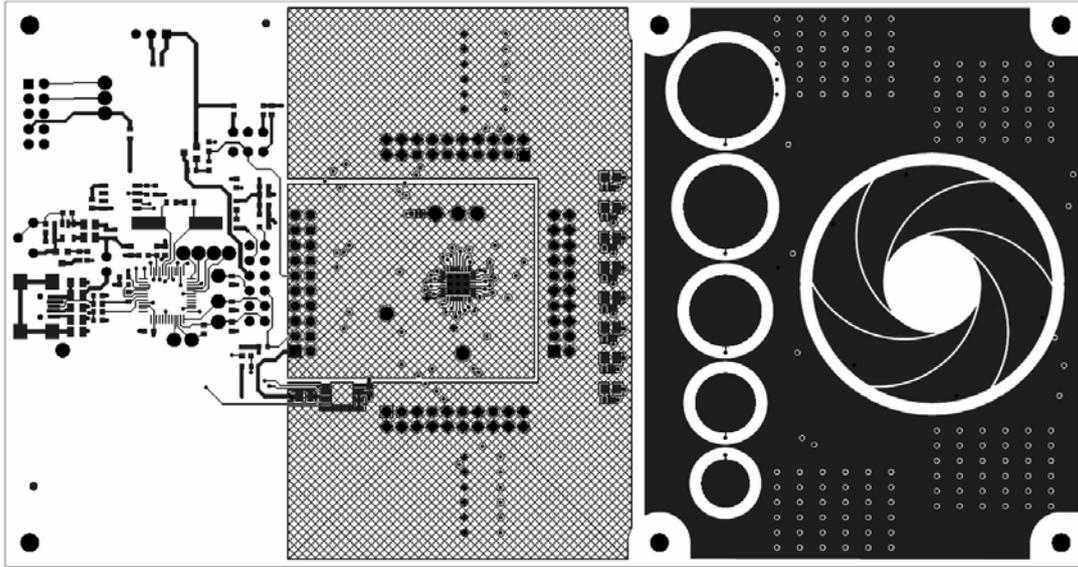

Figure 79: SX8635EVK top layer

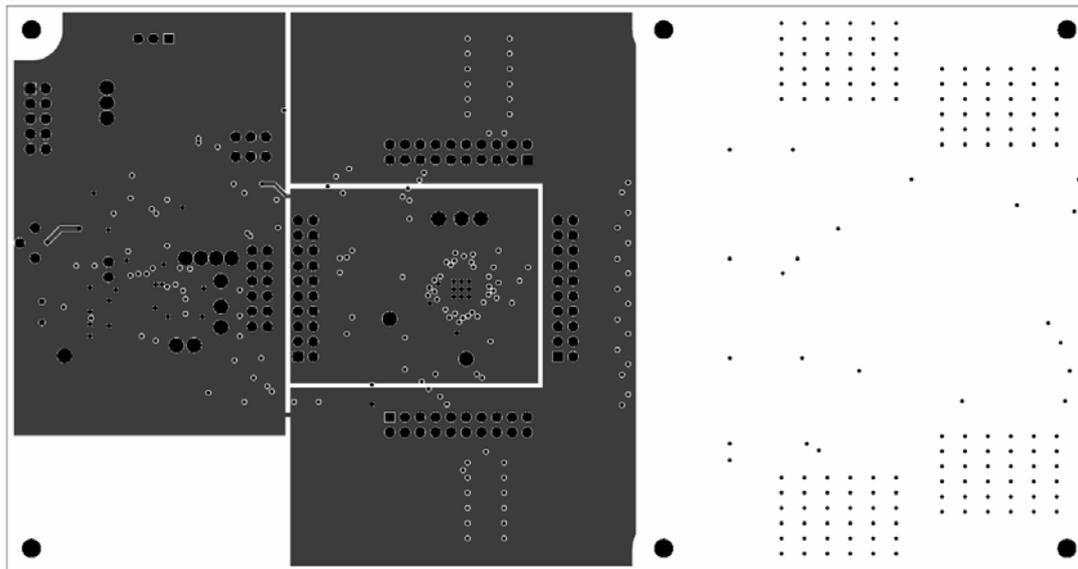

Figure 80: SX8635EVK mid layer 1

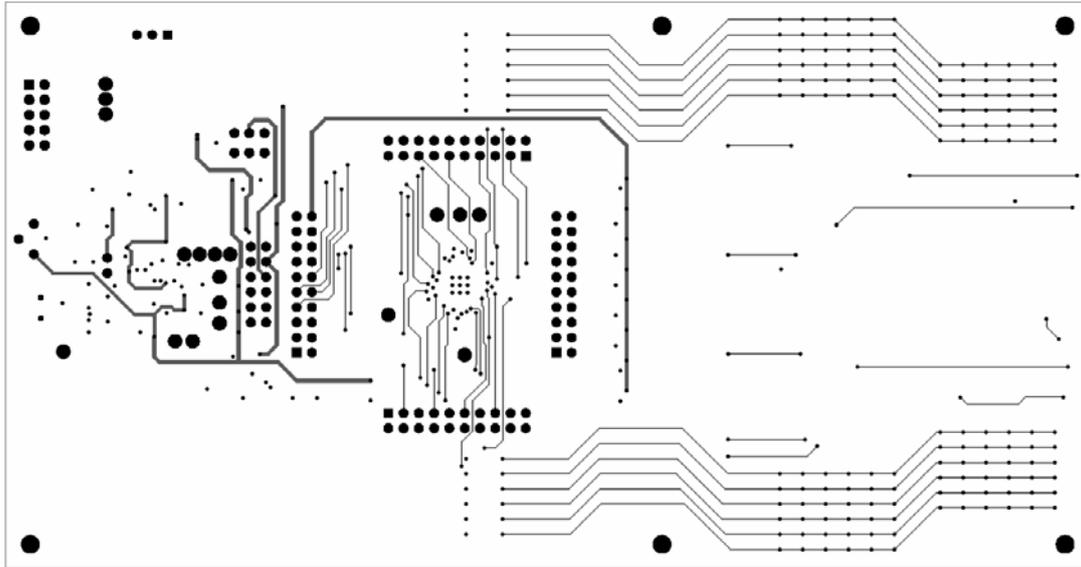

Figure 81: SX8635EVK mid layer 2

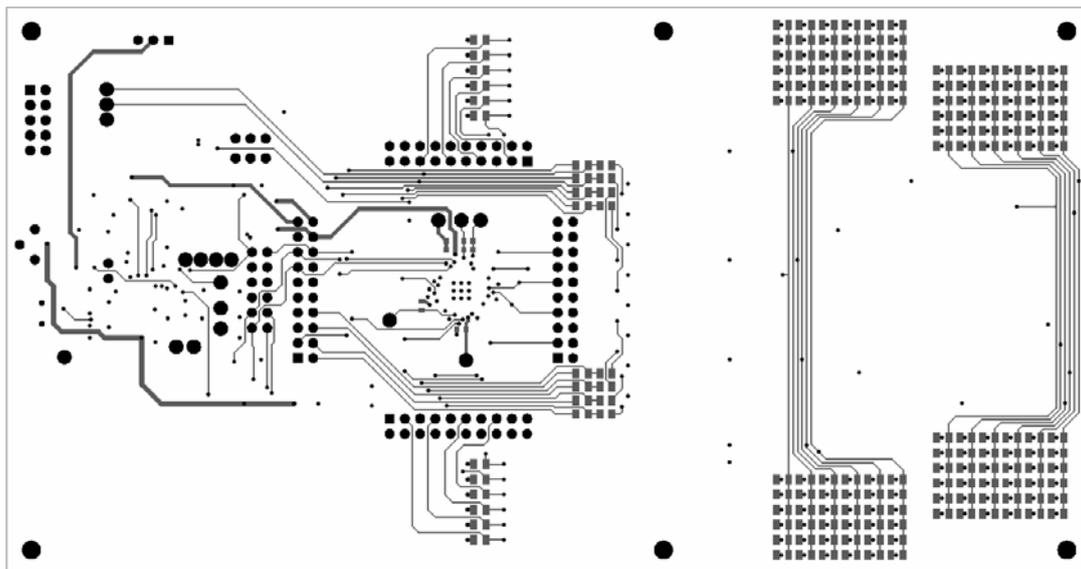

Figure 82: SX8635EVK bottom layer

FR4 1,6mm Cu35u
Stack Layer

TOP Solder Mask : 25 - 30uM
 TOP Copper : 35uM
 EPOXY : 380uM
 Mid Layer 1 Copper : 35uM
 EPOXY : 700uM
 Mid Layer 2 Copper : 35uM
 EPOXY : 380uM
 BOT Copper : 35uM
 BOT Solder Mask : 25 - 30uM

Figure 83: SX8634/44EVK, SX8635/45EVK stacked layer information

8 References

- [1] SX8643 Datasheet
- [2] SX8644 Datasheet
- [3] SX8645 Datasheet
- [4] SX8646 Datasheet
- [5] SX8647 Datasheet
- [6] SX8648 Datasheet
- [7] SX8649 Datasheet
- [8] SX8633 Datasheet
- [9] SX8634 Datasheet
- [10] SX8635 Datasheet
- [11] SX8636 Datasheet
- [12] SX8638 Datasheet
- [13] SX8639 Datasheet

ADVANCED COMMUNICATIONS & SENSING

© Semtech 2010

All rights reserved. Reproduction in whole or in part is prohibited without the prior written consent of the copyright owner. The information presented in this document does not form part of any quotation or contract, is believed to be accurate and reliable and may be changed without notice. No liability will be accepted by the publisher for any consequence of its use. Publication thereof does not convey nor imply any license under patent or other industrial or intellectual property rights. Semtech assumes no responsibility or liability whatsoever for any failure or unexpected operation resulting from misuse, neglect improper installation, repair or improper handling or unusual physical or electrical stress including, but not limited to, exposure to parameters beyond the specified maximum ratings or operation outside the specified range.

SEMTECH PRODUCTS ARE NOT DESIGNED, INTENDED, AUTHORIZED OR WARRANTED TO BE SUITABLE FOR USE IN LIFE-SUPPORT APPLICATIONS, DEVICES OR SYSTEMS OR OTHER CRITICAL APPLICATIONS. INCLUSION OF SEMTECH PRODUCTS IN SUCH APPLICATIONS IS UNDERSTOOD TO BE UNDERTAKEN SOLELY AT THE CUSTOMER'S OWN RISK. Should a customer purchase or use Semtech products for any such unauthorized application, the customer shall indemnify and hold Semtech and its officers, employees, subsidiaries, affiliates, and distributors harmless against all claims, costs damages and attorney fees which could arise.

Contact Information

Semtech Corporation
Advanced Communications and Sensing Products Division
200 Flynn Road, Camarillo, CA 93012
Phone: (805) 498-2111 Fax: (805) 498-3804