

# PXAC241702FC

## Thermally-Enhanced High Power RF LDMOS FET 150 W, 28 V, 2300 – 2400 MHz

### Description

The PXAC241702FC is a 28 V LDMOS FET with an asymmetrical design intended for use in multi-standard cellular power amplifier applications in the 2300 to 2400 MHz frequency band. Features include dual-path design, high gain and thermally-enhanced package with earless flange. Manufactured with Wolfspeed's advanced LDMOS process, this device provides excellent thermal performance and superior reliability.



PXAC241702FC  
Package H-37248-4

### Features

- Asymmetrical Doherty design
  - Main:  $P_{1dB} = 60$  W Typ
  - Peak:  $P_{1dB} = 90$  W Typ
- Broadband internal input and output matching
- Typical pulsed CW performance, 2350 MHz, 28 V, Doherty configuration
  - Output power at  $P_{1dB} = 100$  W
  - Efficiency = 49%
  - Gain = 17.5 dB
- Integrated ESD protection: Human Body Model, Class 1C (per JESD22-A114)
- Capable of handling 10:1 VSWR @28 V, 120 W (CW) output power
- Low thermal resistance
- Pb-free and RoHS compliant

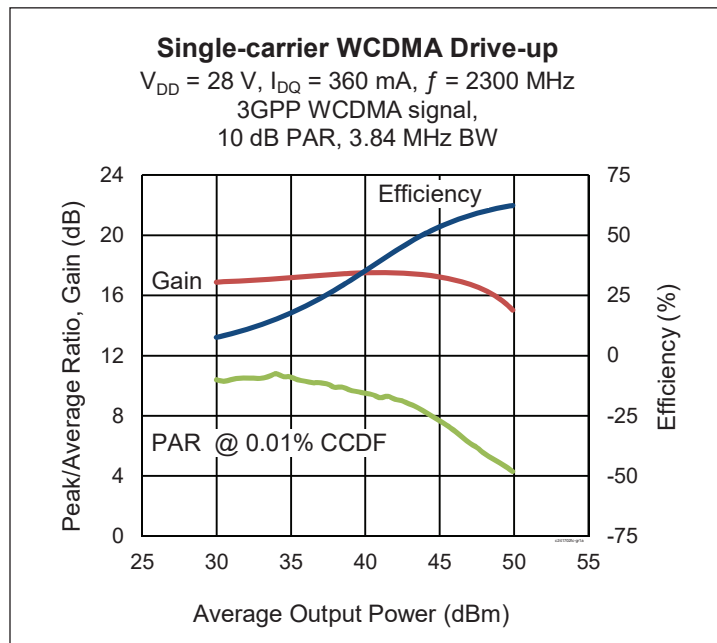

### RF Characteristics

#### Single-carrier WCDMA Specifications (tested in Wolfspeed Doherty test fixture)

$V_{DD} = 28$  V,  $I_{DQ(main)} = 360$  mA,  $V_{GS(peak)} = 1.2$  V,  $P_{OUT} = 28$  W avg,  $f = 2400$  MHz, 3GPP signal, 3.84 MHz channel bandwidth, 10 dB peak/average @ 0.01% probability on CCDF.

Characteristic	Symbol	Min	Typ	Max	Unit
Gain	$G_{ps}$	15.5	16.5	—	dB
Drain Efficiency	$\eta_D$	46	52	—	%
Adjacent Channel Power Ratio	ACPR	—	-33.5	-28.0	dBc
Output PAR (at 0.01% probability on CCDF)	OPAR	6.5	7.5	—	dB

All published data at  $T_{CASE} = 25^\circ\text{C}$  unless otherwise indicated

ESD: Electrostatic discharge sensitive device—observe handling precautions!

**DC Characteristics** (each side)

Characteristic	Conditions	Symbol	Min	Typ	Max	Unit
Drain-Source Breakdown Voltage	$V_{GS} = 0\text{ V}, I_{DS} = 10\text{ mA}$	$V_{(BR)DSS}$	65	—	—	V
Drain Leakage Current	$V_{DS} = 28\text{ V}, V_{GS} = 0\text{ V}$	$I_{DSS}$	—	—	1	$\mu\text{A}$
	$V_{DS} = 63\text{ V}, V_{GS} = 0\text{ V}$	$I_{DSS}$	—	—	10	$\mu\text{A}$
Gate Leakage Current	$V_{GS} = 10\text{ V}, V_{DS} = 0\text{ V}$	$I_{GSS}$	—	—	1	$\mu\text{A}$
On-State Resistance	(main) $V_{GS} = 10\text{ V}, V_{DS} = 0.1\text{ V}$	$R_{DS(on)}$	—	0.19	—	$\Omega$
	(peak) $V_{GS} = 10\text{ V}, V_{DS} = 0.1\text{ V}$	$R_{DS(on)}$	—	0.16	—	$\Omega$
Operating Gate Voltage	(main) $V_{DS} = 28\text{ V}, I_{DQ} = 360\text{ mA}$	$V_{GS}$	2.3	2.65	3.0	V
	(peak) $V_{DS} = 28\text{ V}, I_{DQ} = 0\text{ mA}$	$V_{GS}$	0.8	1.30	1.8	V

**Maximum Ratings**

Parameter	Symbol	Value	Unit
Drain-Source Voltage	$V_{DSS}$	65	V
Gate-Source Voltage	$V_{GS}$	-6 to +10	V
Operating Voltage	$V_{DD}$	0 to +32	V
Junction Temperature	$T_J$	225	$^{\circ}\text{C}$
Storage Temperature Range	$T_{STG}$	-65 to +150	$^{\circ}\text{C}$
Thermal Resistance ( $T_{CASE} = 70^{\circ}\text{C}, 100\text{ W CW}$ )	$R_{\theta JC}$	0.53	$^{\circ}\text{C/W}$

**Ordering Information**

Type and Version	Order Code	Package and Description	Shipping
PXAC241702FC V1 R0	PXAC241702FC-V1-R0	H-37248-4, ceramic open-cavity, push-pull, earless	Tape & Reel, 50 pcs
PXAC241702FC V1 R250	PXAC241702FC-V1-R250	H-37248-4, ceramic open-cavity, push-pull, earless	Tape & Reel, 250 pcs

**Typical Performance** (data taken in an Wolfspeed production test fixture)

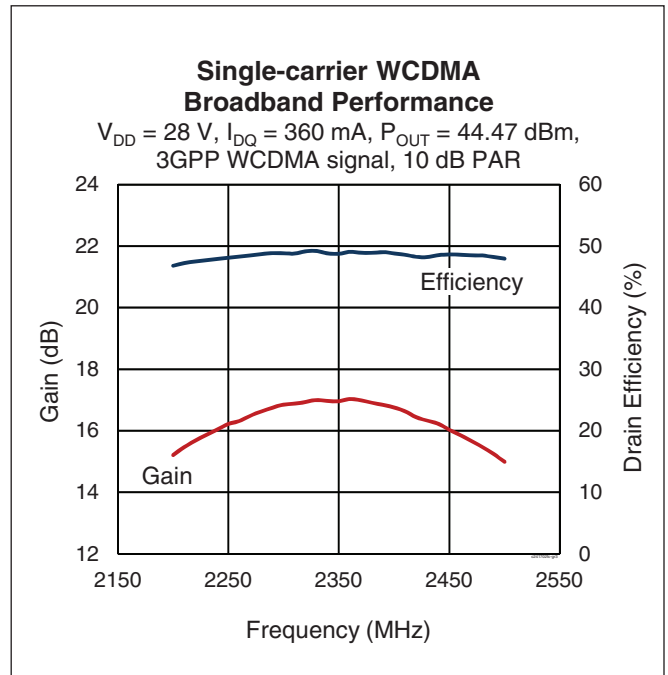
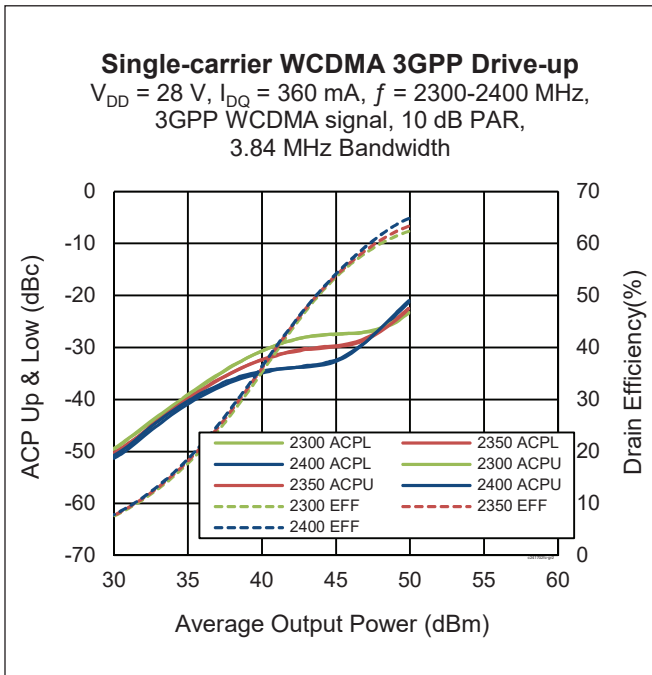
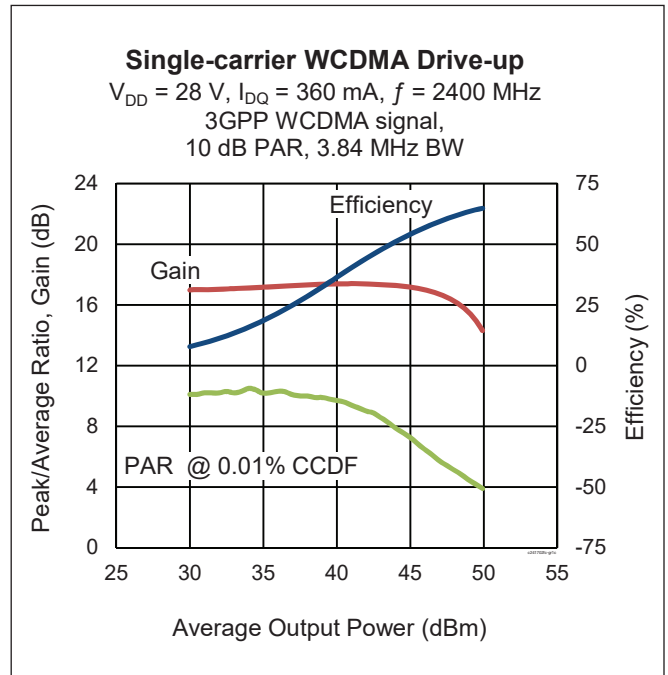
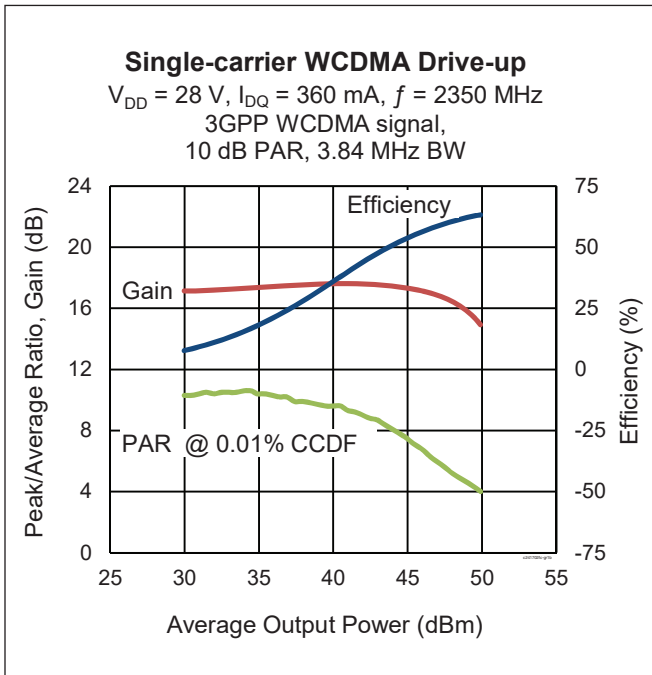

Typical Performance (cont.)

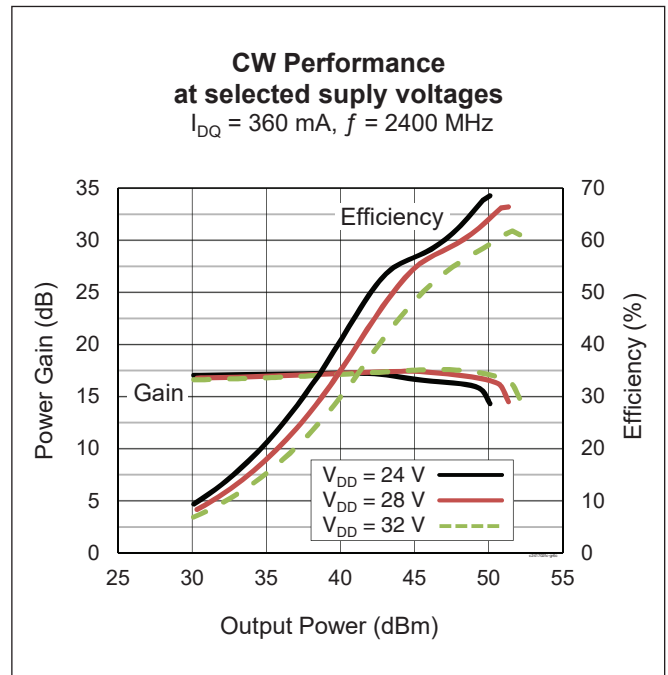
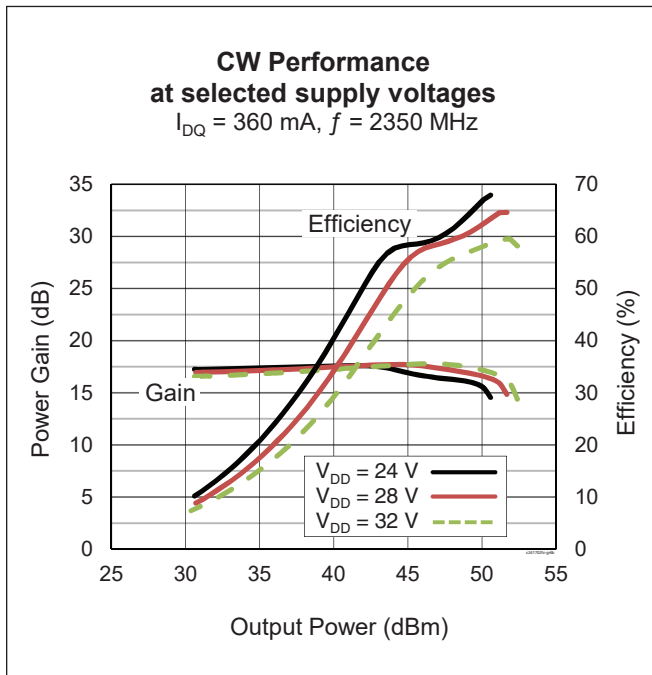
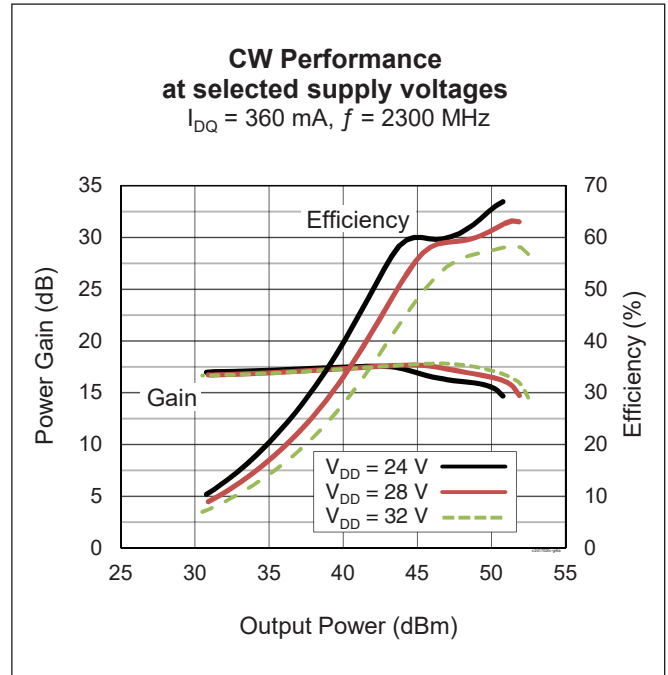
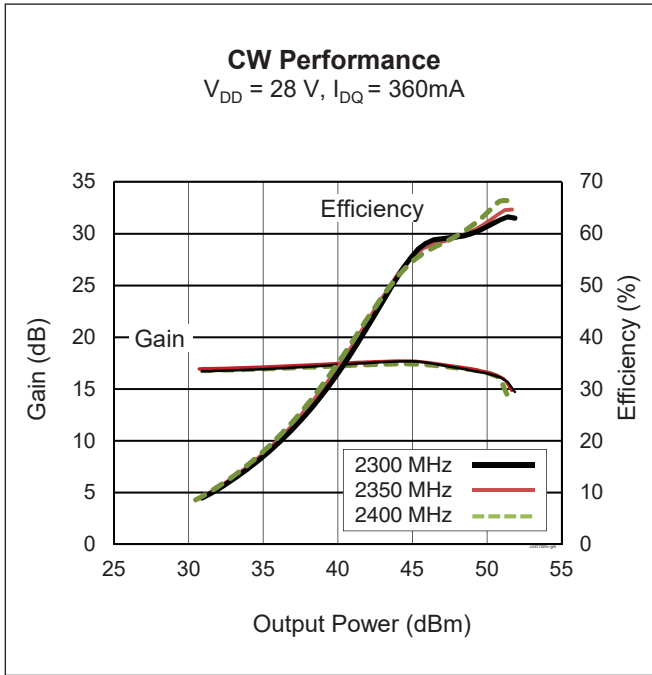

**Typical Performance** (cont.)

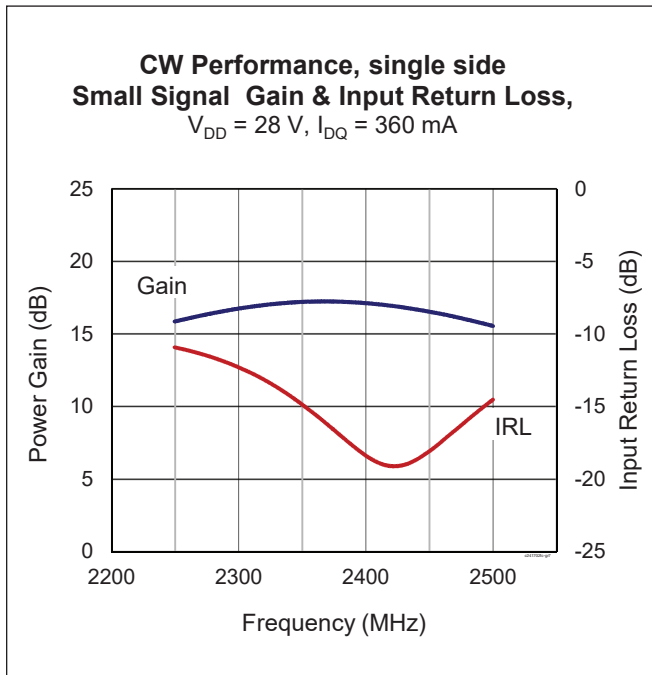

See next page for load pull performance



### Load Pull Performance

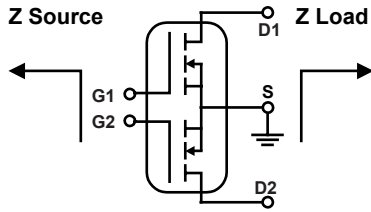

Main side pulsed CW signal: 160  $\mu$ sec, 10% duty cycle; 28 V, 360 mA

Class AB		P <sub>1dB</sub>										
		Max Output Power					Max Efficiency					
Freq [MHz]	Z <sub>in</sub> [ $\Omega$ ]	Gain [dB]	PAE [%]	P <sub>OUT</sub> [dBm]	P <sub>OUT</sub> [W]	Z <sub>o</sub> [ $\Omega$ ]	Gain [dB]	PAE [%]	P <sub>OUT</sub> [dBm]	P <sub>OUT</sub> [W]	Z <sub>o</sub> [ $\Omega$ ]	
2300	7.02 – j16.25	18.46	48.25	48.26	66.99	3.70 – j5.99	21.09	60.29	46.10	40.78	7.31 – j2.51	
2350	8.74 – j17.99	18.55	51.07	48.10	64.57	3.95 – j6.20	21.35	58.44	45.56	35.96	6.07 – j1.30	
2400	12.84 – j19.05	18.51	49.06	47.87	61.24	4.07 – j6.49	21.28	58.55	45.90	38.91	5.53 – j1.93	

Peak side pulsed CW signal: 160  $\mu$ sec, 10% duty cycle; 28 V, 540 mA

Class AB		P <sub>1dB</sub>										
		Max Output Power					Max Efficiency					
Freq [MHz]	Z <sub>in</sub> [ $\Omega$ ]	Gain [dB]	PAE [%]	P <sub>OUT</sub> [dBm]	P <sub>OUT</sub> [W]	Z <sub>o</sub> [ $\Omega$ ]	Gain [dB]	PAE [%]	P <sub>OUT</sub> [dBm]	P <sub>OUT</sub> [W]	Z <sub>o</sub> [ $\Omega$ ]	
2300	6.20 – j13.36	17.67	52.03	50.03	100.69	2.61 – j6.18	19.73	59.11	48.52	71.07	4.52 – j4.62	
2350	8.28 – j12.82	17.83	50.54	49.84	96.38	2.65 – j6.19	19.83	56.93	48.23	66.48	4.23 – j4.25	
2400	10.47 – j14.25	17.66	49.75	49.77	94.84	2.52 – j6.34	20.75	56.70	47.17	52.14	4.10 – j2.69	

Peak side pulsed CW signal: 160  $\mu$ sec, 10% duty cycle; 28 V, V<sub>G</sub> = 1.5 V

Class C		P <sub>1dB</sub>										
		Max Output Power					Max Efficiency					
Freq [MHz]	Z <sub>in</sub> [ $\Omega$ ]	Gain [dB]	PAE [%]	P <sub>OUT</sub> [dBm]	P <sub>OUT</sub> [W]	Z <sub>o</sub> [ $\Omega$ ]	Gain [dB]	PAE [%]	P <sub>OUT</sub> [dBm]	P <sub>OUT</sub> [W]	Z <sub>o</sub> [ $\Omega$ ]	
2300	6.20 – j13.36	14.18	58.22	50.38	109.14	2.47 – j5.92	15.13	64.64	48.83	76.42	4.33 – j4.75	
2350	8.28 – j12.82	13.92	55.03	50.16	103.75	2.45 – j6.22	14.84	61.91	49.20	83.25	3.70 – j5.15	
2400	10.47 – j14.25	14.08	53.80	50.08	101.86	2.31 – j6.36	15.19	60.42	47.54	56.77	4.17 – j3.00	

### Reference Circuit, 2300 MHz to 2400 MHz

DUT	PXAC241702FC V1
Reference Circuit Part No.	LTA/PXAC241702FC V1
PCB	Rogers 4350, 0.508 mm [.020"] thick, 2 oz. copper, $\epsilon_r = 3.66$
Find Gerber files for this reference circuit on the Wolfspeed Web site at <a href="http://www.wolfspeed.com/RF">www.wolfspeed.com/RF</a>	

**Reference Circuit** (cont.)

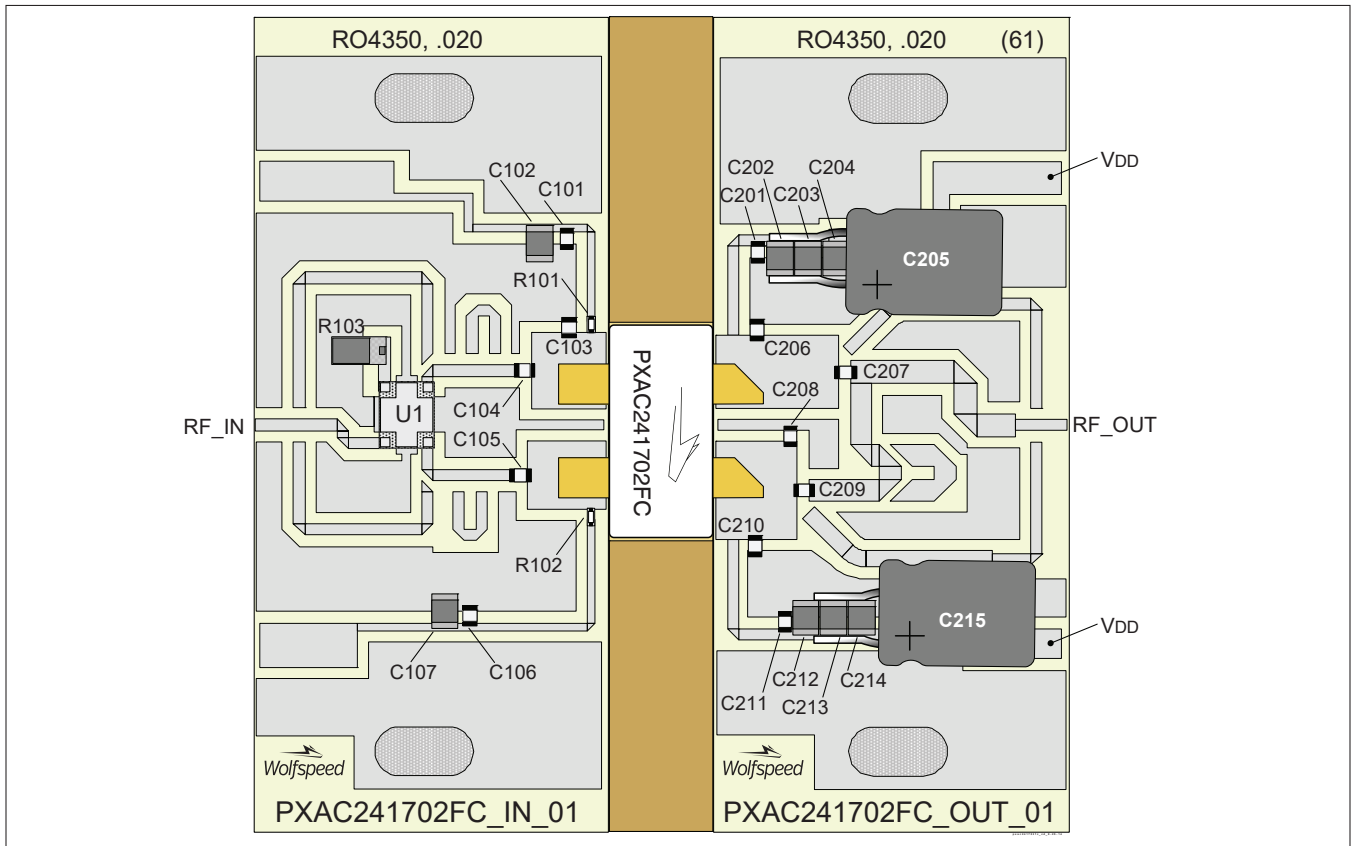

Reference circuit assembly diagram (not to scale)

**Component Information**

Component	Description	Manufacturer	P/N
<b>Input</b>			
C101, C104, C105, C106	Capacitor, 15 pF	ATC	600F150JT250
C102, C107	Capacitor, 10 µF	Taiyo Yuden	UMK325C7106MM-T
C103	Capacitor, 0.3 pF	ATC	600F0R3BT250
R101, R102	Chip resistor, 10 ohms	Panasonic Electronic Components	ERJ-8GEYJ101V
R103	Chip resistor, 50 ohms	Anaren	C16A50Z4
U1	Coupler	Anaren	X3C25P1-02S
<b>Output</b>			
C201, C209, C211	Capacitor, 15 pF	ATC	600F150JT250
C202, C203, C204, C212, C213, C214	Capacitor, 10 µF	Taiyo Yuden	UMK325C7106MM-T
C205, C215	Capacitor, 220 µF, 50 V	Cornell Dubilier Electronics (CDE)	SK221M050ST
C206	Capacitor, 0.6 pF	ATC	600F0R6BT250
C207	Capacitor, 4.7 pF	ATC	600F4R7BT250
C208, C210	Capacitor, 1.2 pF	ATC	600F 1R2BT250



**Pinout Diagram** (top view)

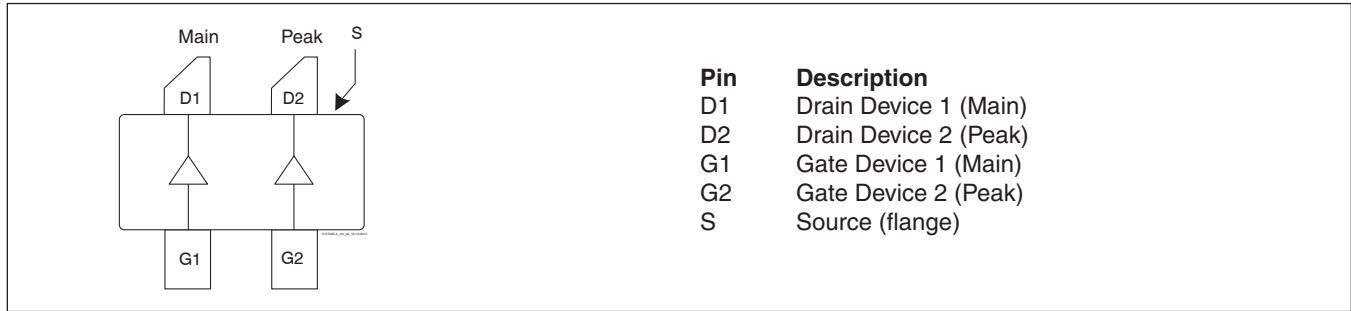

Lead connections for PXAC241702FC

**See next page for package mechanical specifications**



Package Outline Specifications

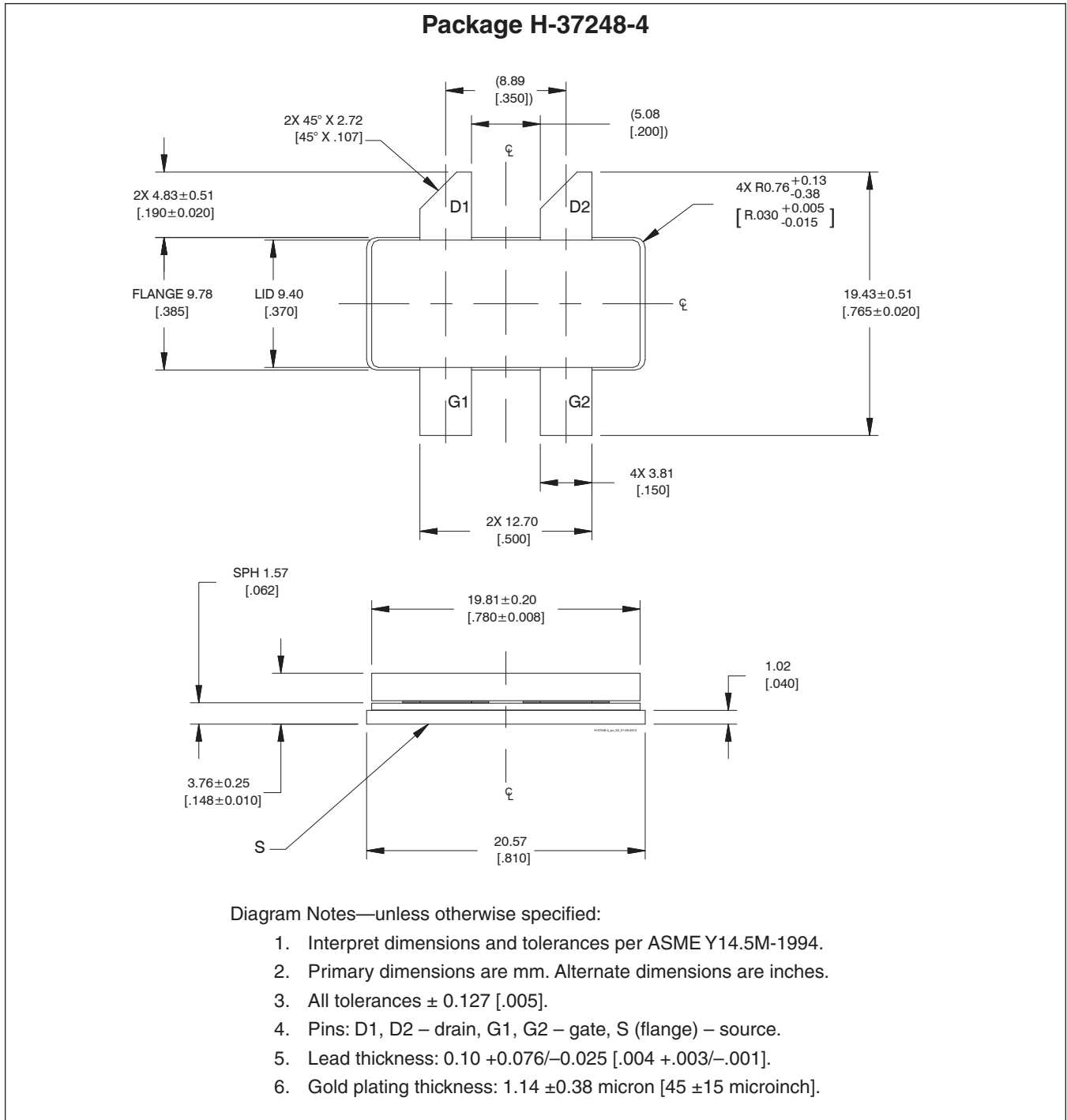

## Revision History

Revision	Date	Data Sheet Type	Page	Subjects (major changes since last revision)
01	2014-04-04	Advance	All	Data Sheet reflects advance specification for product development
02	2014-08-28	Production	All	Data Sheet represents released product specifications, including reference circuit and updated performance information.
02.1	2016-06-22	Production	2	Updated ordering information
03	2018-07-03	Production	All	Converted to Wolfspeed Data Sheet

For more information, please contact:

4600 Silicon Drive  
 Durham, North Carolina, USA 27703  
[www.wolfspeed.com/RF](http://www.wolfspeed.com/RF)

Sales Contact  
[RFSales@wolfspeed.com](mailto:RFSales@wolfspeed.com)

RF Product Marketing Contact  
[RFMarketing@wolfspeed.com](mailto:RFMarketing@wolfspeed.com)  
 919.407.7816

## Notes

---

### Disclaimer

Specifications are subject to change without notice. Cree, Inc. believes the information contained within this data sheet to be accurate and reliable. However, no responsibility is assumed by Cree for any infringement of patents or other rights of third parties which may result from its use. No license is granted by implication or otherwise under any patent or patent rights of Cree. Cree makes no warranty, representation or guarantee regarding the suitability of its products for any particular purpose. "Typical" parameters are the average values expected by Cree in large quantities and are provided for information purposes only. These values can and do vary in different applications and actual performance can vary over time. All operating parameters should be validated by customer's technical experts for each application. Cree products are not designed, intended or authorized for use as components in applications intended for surgical implant into the body or to support or sustain life, in applications in which the failure of the Cree product could result in personal injury or death or in applications for planning, construction, maintenance or direct operation of a nuclear facility.