



Technical Data Sheet

High Performance SMD LED with Reflector

93-22SURSYGC/S530-A3/TR8

Features

- Package in 12mm tape on 7" diameter reels.
- Compatible with automatic placement equipment.
- Compatible with infrared and vapor phase reflow solder process.
- EIA std. package.
- IC compatible.
- Pb-free.
- The product itself will remain within RoHS compliant version.

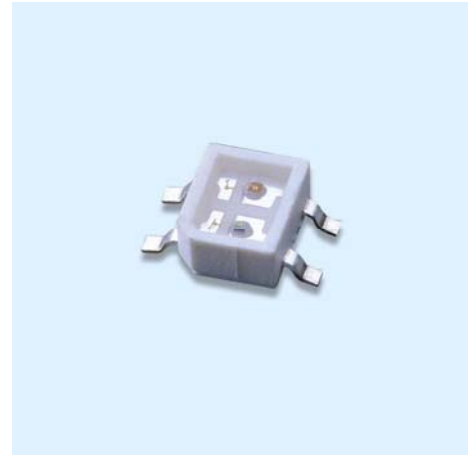

Applications

- Telecommunication: indicator and backlighting in telephone and fax.
- Indicator and backlight for audio and video equipment.
- Indicator and backlight for battery driven equipment.
- Small indicator for outdoor applications.
- Indicator and backlight in office equipment.
- Flat backlight for LED, switches and symbol.
- General use.

Device Selection Guide

Chip		Emitted Color	Resin Color
Type	Material		
SUR	AlGaInP	Brilliant Red	Water Clear
SYG	AlGaInP	Brilliant Yellow Green	



Technical Data Sheet

High Performance SMD LED with Reflector

93-22SURSYGC/S530-A3/TR8

Package Dimensions

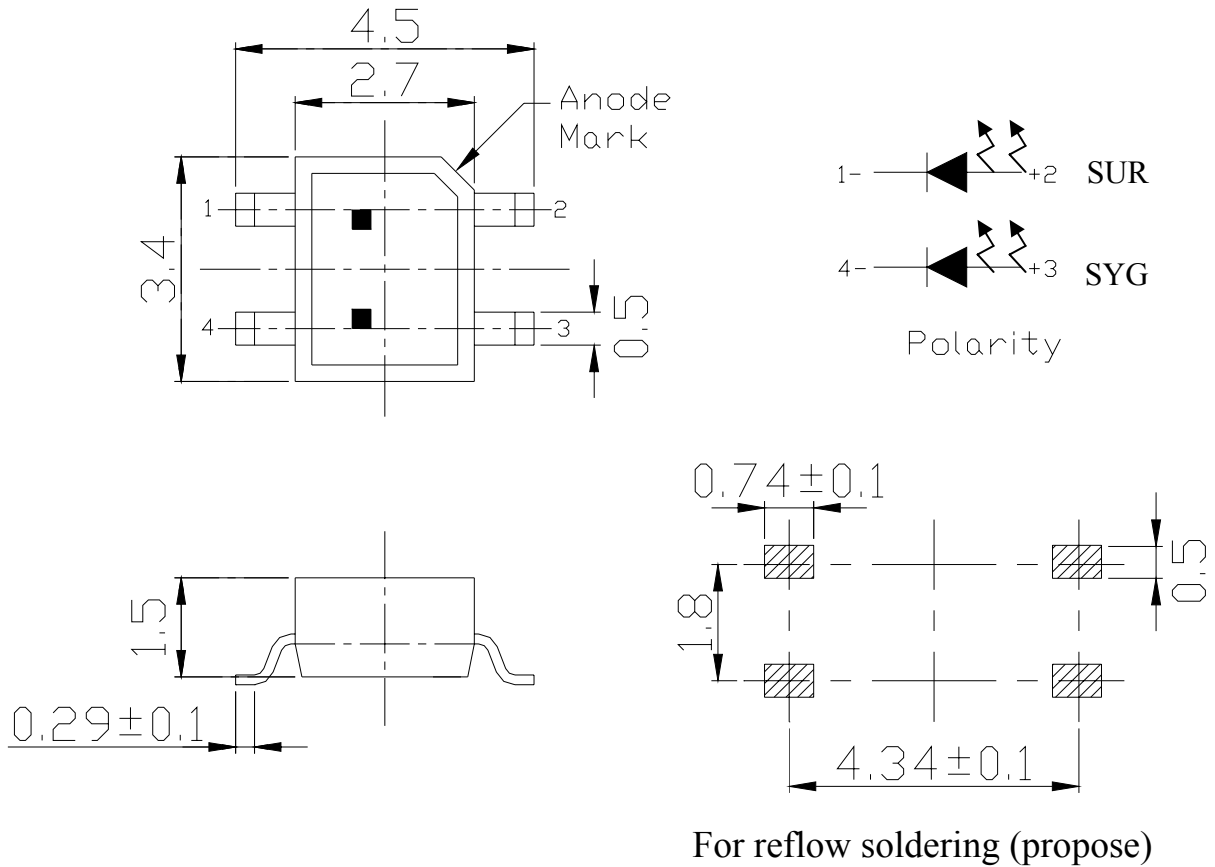

- Notes:** 1. All dimensions are in millimeters.
2. Tolerance unless mentioned is ± 0.1 mm.

For reflow soldering (propose)

**Technical Data Sheet****High Performance SMD LED with Reflector****93-22SURSYGC/S530-A3/TR8****Absolute Maximum Ratings @Ta=25°C**

Parameter	Symbol	Rating	Unit	
Reverse Voltage	V_R	5	V	
Forward Current	I_F	SUR	25	mA
		SYG		
Peak Forward Current (Duty 1/10 @ 1KHz)	I_{FP}	SUR	60	mA
		SYG		
Power Dissipation	P_d	SUR	60	mW
		SYG		
Electrostatic Discharge(HBM)	ESD	2000	V	
Operating Temperature	T_{opr}	-40 ~ +85	°C	
Storage Temperature	T_{stg}	-40~ +100	°C	
Soldering Temperature	T_{sol}	Reflow Soldering : 260 °C for 10 sec. Hand Soldering : 350 °C for 3 sec.		

**Technical Data Sheet****High Performance SMD LED with Reflector****93-22SURSYGC/S530-A3/TR8****Electro-Optical Characteristics @ Ta=25°C**

Parameter	Symbol	Min.	Typ.	Max.	Unit	Condition	
Luminous Intensity	I _v	SUR	17	41	-----	mcd	I _F =20mA
		SYG	11	17	-----		
Viewing Angle	2θ _{1/2}	-----	130	-----	deg	I _F =20mA	
Peak Wavelength	λ _p	SUR	-----	632	-----	nm	I _F =20mA
		SYG	-----	575	-----		
Dominant Wavelength	λ _d	SUR	-----	624	-----	nm	I _F =20mA
		SYG	-----	573	-----		
Spectrum Radiation Bandwidth	Δλ	SUR	-----	20	-----	nm	I _F =20mA
		SYG	-----	20	-----		
Forward Voltage	V _F	SUR	-----	2.0	2.4	V	I _F =20mA
		SYG	-----	2.0	2.4		
Reverse Current	I _R	-----	-----	10	μA	V _R =5V	



Technical Data Sheet

High Performance SMD LED with Reflector

93-22SURSYGC/S530-A3/TR8

Typical Electro-Optical Characteristics Curves(SUR)

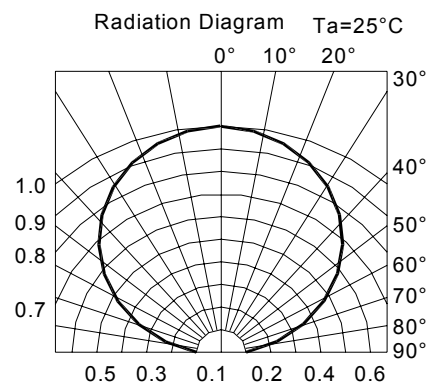
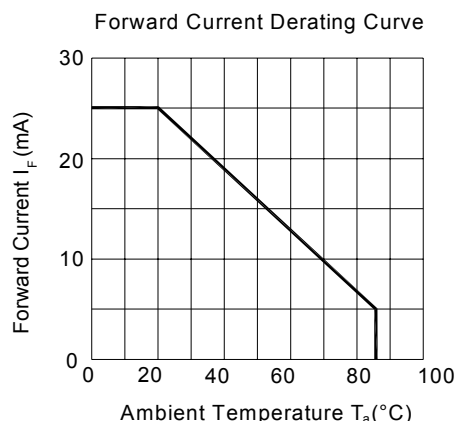
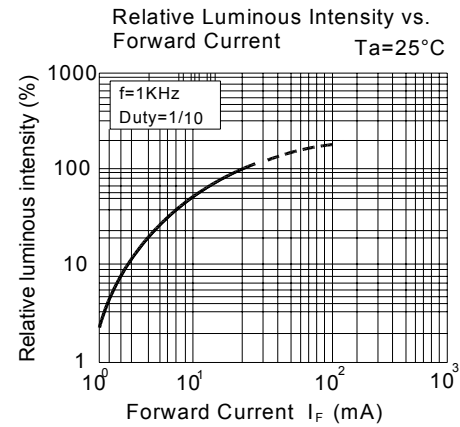
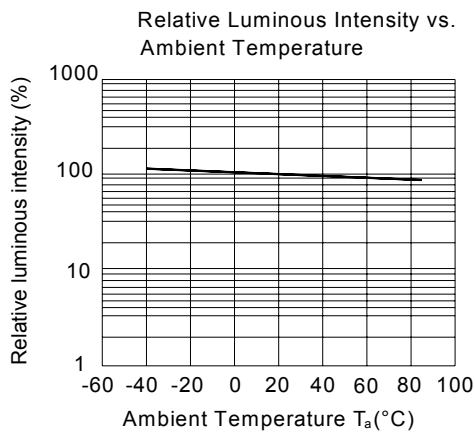
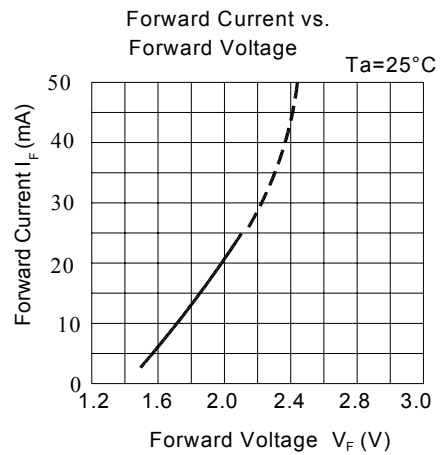
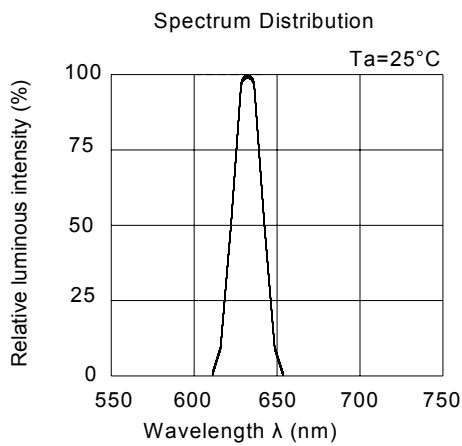



Technical Data Sheet

High Performance SMD LED with Reflector

93-22SURSYGC/S530-A3/TR8

Typical Electro-Optical Characteristics Curves(SYG)

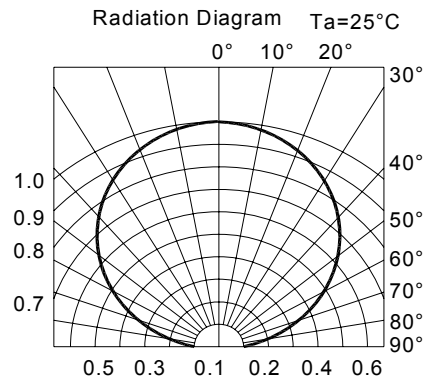
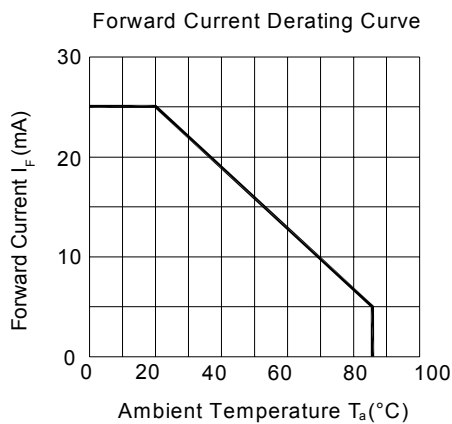
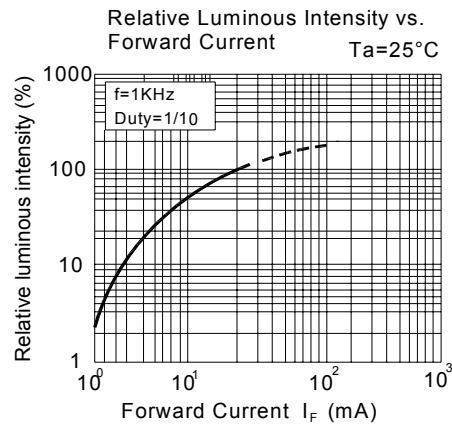
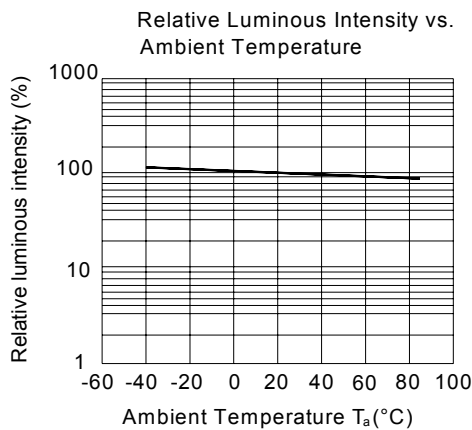
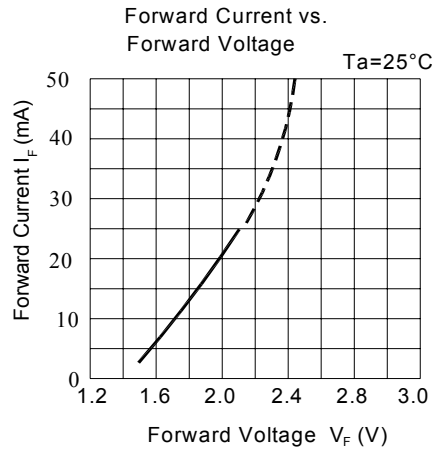
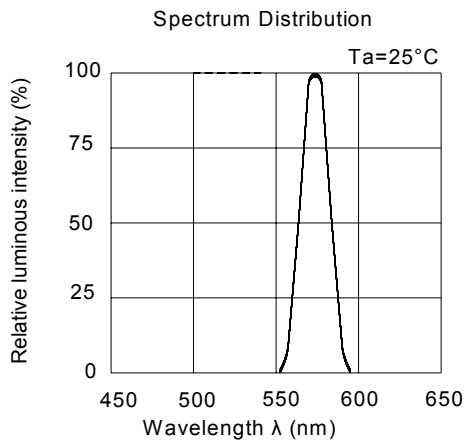



Technical Data Sheet

High Performance SMD LED with Reflector

93-22SURSYGC/S530-A3/TR8

Label Explanation

CAT: Luminous Intensity Rank

HUE: Dom. Wavelength Rank

REF: Forward Voltage Rank

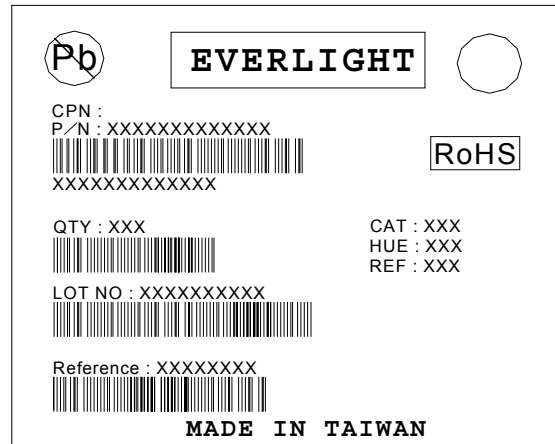

Reel Dimensions

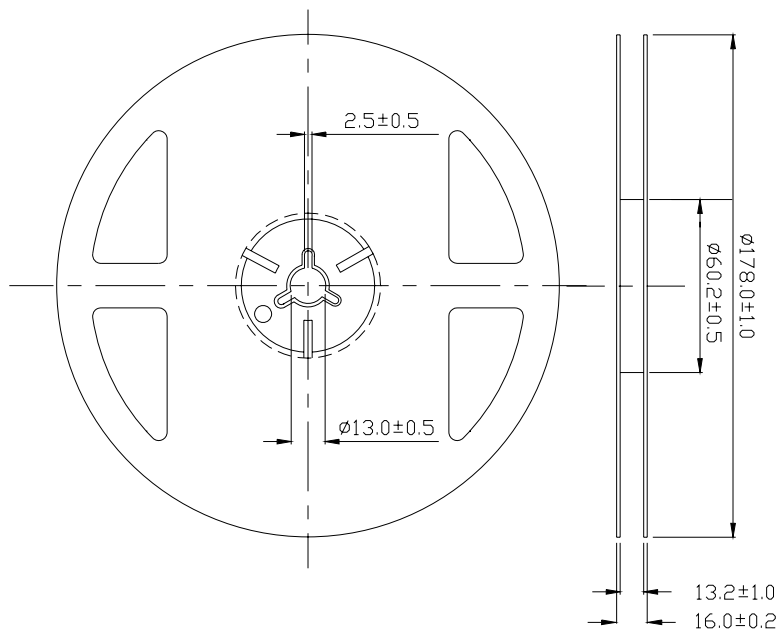

Note: Tolerance unless mentioned is ± 0.1 mm; Unit = mm

Technical Data Sheet

High Performance SMD LED with Reflector

93-22SURSYGC/S530-A3/TR8

Carrier Tape Dimensions: Loaded quantity per reel 1000 PCS/reel

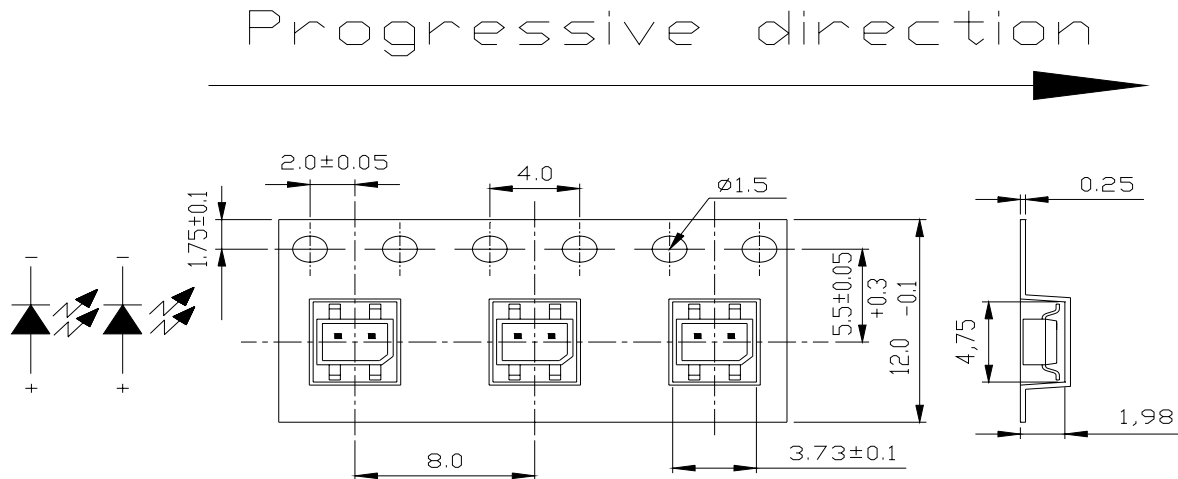

Note: Tolerance unless mentioned is ±0.1mm; Unit = mm

Moisture Resistant Packaging

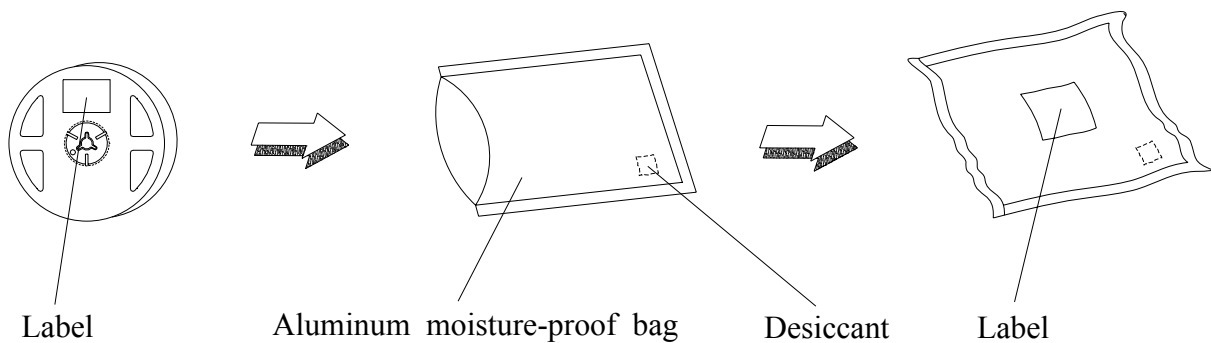

**Technical Data Sheet****High Performance SMD LED with Reflector****93-22SURSYGC/S530-A3/TR8****Reliability Test Items and Conditions**

The reliability of products shall be satisfied with items listed below.

Confidence level : 90%

LTPD : 10%

No.	Items	Test Condition	Test Hours/Cycles	Sample Size	Ac/Re
1	Reflow Soldering	Temp. : 260°C±5°C Min. 5sec.	6 min	22 PCS.	0/1
2	Temperature Cycle	H : +100°C 15min ∫ 5 min L : -40°C 15min	300 Cycles	22 PCS.	0/1
3	Thermal Shock	H : +100°C 5min ∫ 10 sec L : -10°C 5min	300 Cycles	22 PCS.	0/1
4	High Temperature Storage	Temp. : 100°C	1000 Hrs.	22 PCS.	0/1
5	Low Temperature Storage	Temp. : -40°C	1000 Hrs.	22 PCS.	0/1
6	DC Operating Life	I _F = 20 mA	1000 Hrs.	22 PCS.	0/1
7	High Temperature / High Humidity	85°C / 85%RH	1000 Hrs.	22 PCS.	0/1

Technical Data Sheet

High Performance SMD LED with Reflector

93-22SURSYGC/S530-A3/TR8

Precautions for Use

1. Over-current-proof

Customer must apply resistors for protection; otherwise slight voltage shift will cause big current change (Burn out will happen).

2. Storage

2.1 Do not open moisture proof bag before the products are ready to use.

2.2 Before opening the package: The LEDs should be kept at 30°C or less and 90%RH or less.

2.3 After opening the package: The LED's floor life is 1 year under 30°C or less and 60% RH or less. If unused LEDs remain, it should be stored in moisture proof packages.

2.4 If the moisture absorbent material (silica gel) has faded away or the LEDs have exceeded the storage time, baking treatment should be performed using the following conditions.

Baking treatment: 60±5°C for 24 hours.

3. Soldering Condition

3.1 Pb-free solder temperature profile

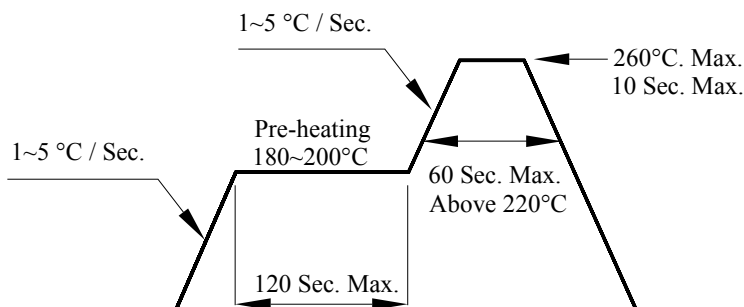

3.2 Reflow soldering should not be done more than two times.

3.3 When soldering, do not put stress on the LEDs during heating.

3.4 After soldering, do not warp the circuit board.



Technical Data Sheet

High Performance SMD LED with Reflector

93-22SURSYGC/S530-A3/TR8

4. Soldering Iron

Each terminal is to go to the tip of soldering iron temperature less than 350°C for 3 seconds within once in less than the soldering iron capacity 25W. Leave two seconds and more intervals, and do soldering of each terminal. Be careful because the damage of the product is often started at the time of the hand solder.

5. Repairing

Repair should not be done after the LEDs have been soldered. When repairing is unavoidable, a double-head soldering iron should be used (as below figure). It should be confirmed beforehand whether the characteristics of the LEDs will or will not be damaged by repairing.

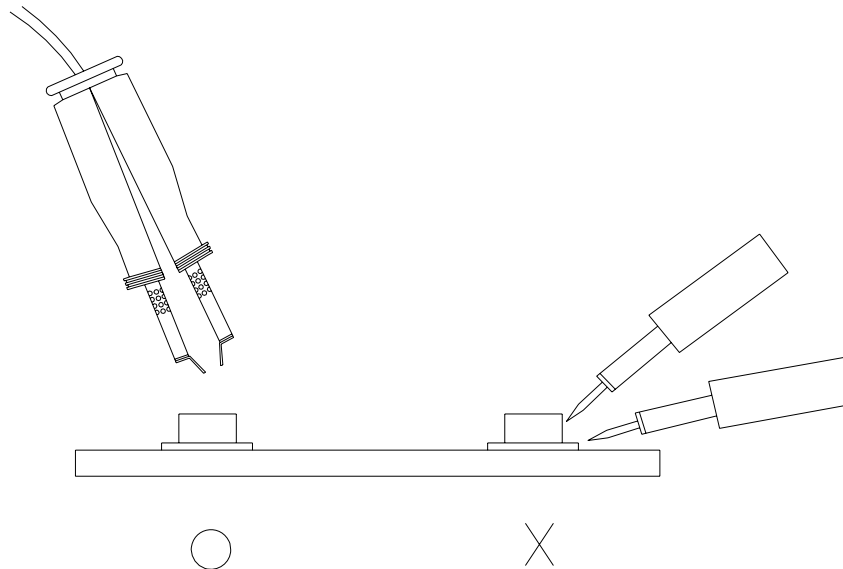

EVERLIGHT ELECTRONICS CO., LTD.
Office: No 25, Lane 76, Sec 3, Chung Yang Rd,
Tucheng, Taipei 236, Taiwan, R.O.C

Tel: 886-2-2267-2000, 2267-9936
Fax: 886-2267-6244, 2267-6189, 2267-6306
<http://www.everlight.com>