

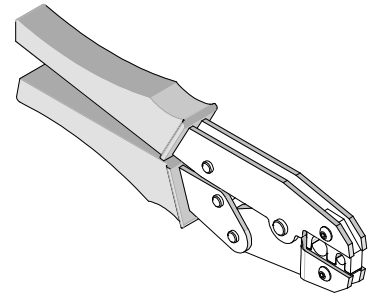

LFH™ FERRULE CRIMP HAND TOOL

Operating Instruction and Specification Sheet

Order No. 62100-0200



FEATURES

- Ratchet with safety release that ensures consistent performance
- Small handle spread which make this style tool ideally suited for end users

SCOPE

Products: LFH™ 60 Circuit Crimp Ferrule

Ferrule	Cable Outer Diameter		Die Set Assembly	Complete Tool
	mm	In		
71256-0002	8.23-9.53	.324-.375	62100-0201	62100-0200

DESCRIPTION

The die set is designed to be used with the Hand Tool Frame Order No. 11-31-6379. The die set is designed to crimp LFH ferrule Order No. 71256-0002 on to a LFH cable assembly.

INSTALLATION

The hand tool frame comes with the die set installed already installed. If the die set needs to be replaced, follow the steps below:

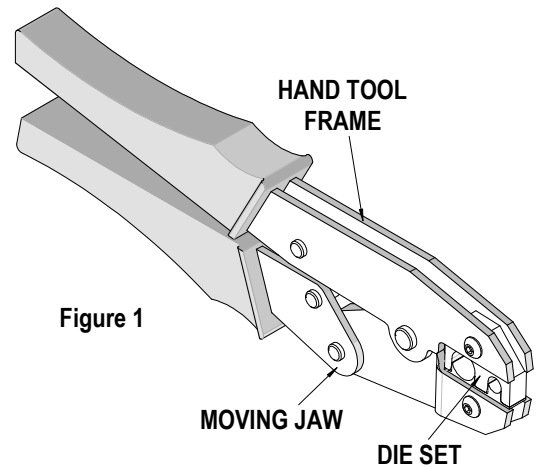

Figure 1

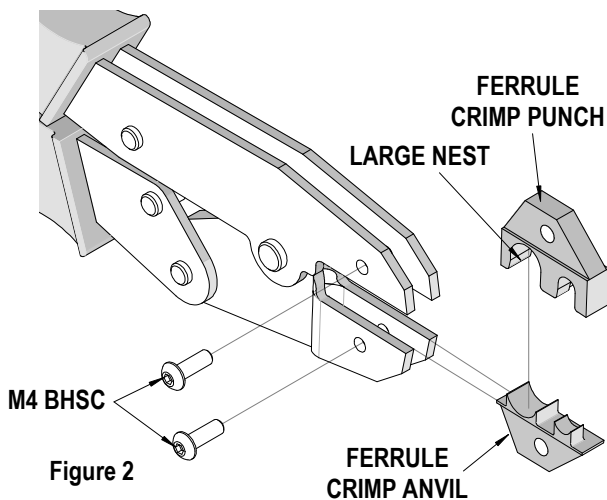

Figure 2

1. Select the proper die set.
2. Remove the two (2) M4 screws.
3. Slide the die set into the tool frame with the larger crimp nest toward the frame's jaws and the crimping anvil going into the moving jaw. See Figure 2.
4. Close the jaws.
5. Reinstall the two (2) M4 screws and tighten securely.

CABLE PREPERATION

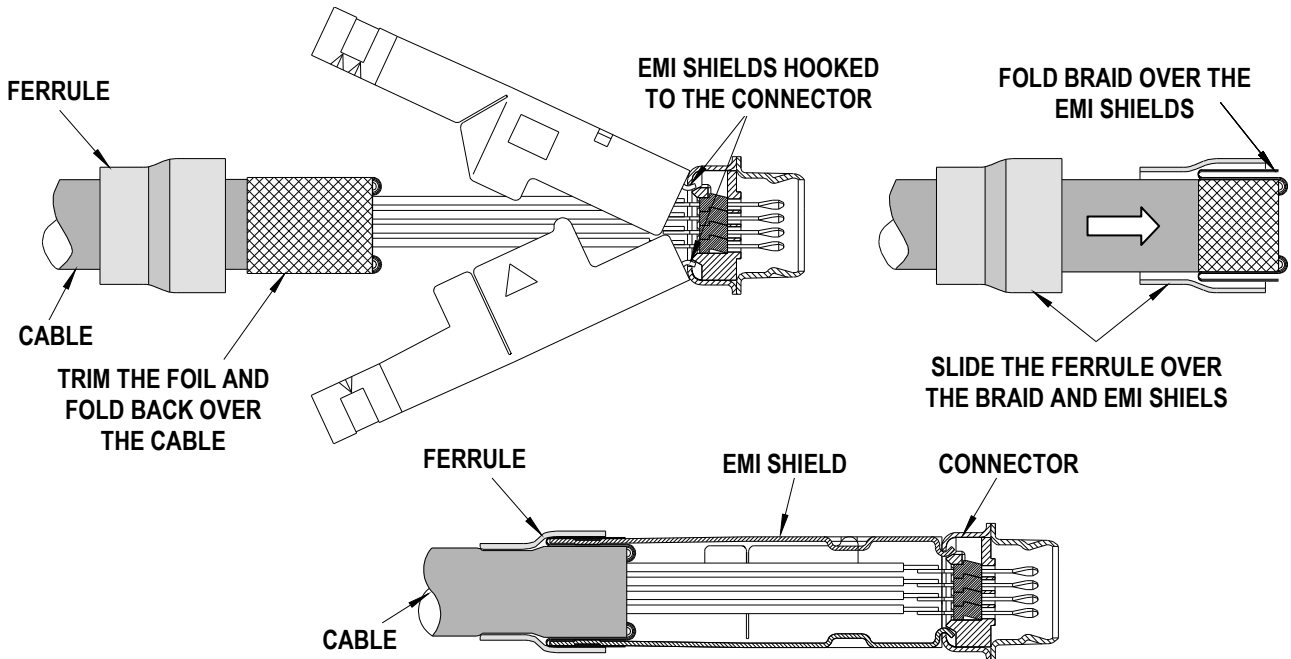

Figure 3

1. Snap EMI shields together making sure they are hooked into the connector.
2. Fold the cable braid over the EMI shield and remove excess braid. Refer to document SDA-71256 for additional information.
3. Install a ferrule over the cable braid and EMI shield as shown in Figure 3.

OPERATION

Open the tool by squeezing the handles together, at the end of the closing stroke, the ratchet mechanism will release the handles, and the hand tool will spring open.

1. Place the cable assembly into the larger die nest in the jaws of the hand tool.
2. Center the larger diameter portion of the ferrule in the die nest.
3. Crimp the ferrule by squeezing the handles until ratchet releases. See Figure 4.

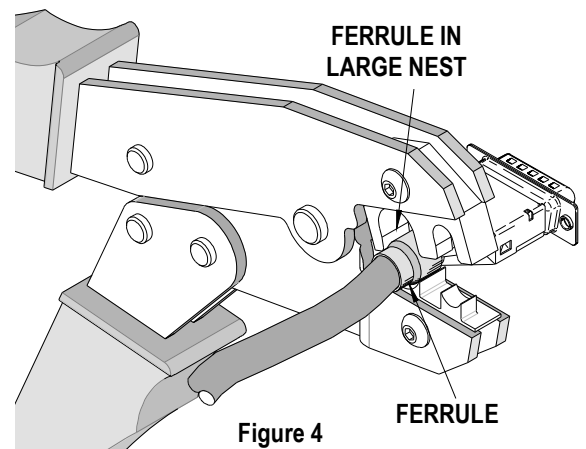

Figure 4

Note: The tamper proof ratchet action will not release the tool until it has been fully closed.

4. Open the tool and carefully remove the cable assembly.
5. Place the cable assembly into the smaller die nest in the jaws of the hand tool.
6. Center the smaller diameter portion of the ferrule in the die nest.
7. Crimp the ferrule by squeezing the handles until ratchet releases.

CAUTION: Be sure to the cable axis is perpendicular to the die set, otherwise a crooked crimp could result.

Maintenance

It is recommended that each operator of the tool be made aware of, and responsible for, the following maintenance steps:

1. Remove dust, moisture, and other contaminants with a clean brush, or soft, lint free cloth.
2. Do not use any abrasive materials that could damage the tool.
3. Make certain all pins, pivot points and bearing surfaces are protected with a thin coat of high quality machine oil. Do not oil excessively.
4. When tool is not in use, keep the handles closed to prevent objects from becoming lodged in the crimping dies, and store the tool in a clean, dry area.

Miscrimps or Jams

Should this tool ever become stuck or jammed in a partially closed position, **Do Not force the handles open or closed.** The tool will open easily by lifting the ratchet release lever. See Figure 5.

How to Adjust Tool Crimp Force (See Figure 5)

It may be necessary over the life of the tool to adjust tool-crimping force. The pre load is the handle force required to release the anti-backup ratchet when the tool is closed without performing a crimp. The pre load should be 35-40lbs (16-18kg). Listed below are the steps required to adjust the crimping force of the hand tool to obtain proper crimp conditions:

1. Remove the screw and washer. Located over the adjustment ring.
2. Lift the adjusting ring slightly, off the locating pin.
3. Turn the adjusting ring in the desired direction (L= less force, T= more force) to increase or decrease crimp pressure.
4. Press the adjusting wheel flat against the tool and engage the locking pin.
5. Replace the washer and screw.
6. Check the crimp specifications after tool crimp force is adjusted.

Warranty

This tool is for electrical terminal crimping purposes only. This tool is made of the best quality materials. All vital components are long life tested. All tools are warranted free of manufacturing defects for a period of **30 days**. Should such a defect occur, we would exchange the tool free of charge. This will not be applicable to altered, misused, or damaged tools. This tool is designed for hand use only. Any clamping, fixturing, or use of handle extensions voids this warranty.

Hand held crimping tools are intended for low volume, prototyping, or repair requirements only.

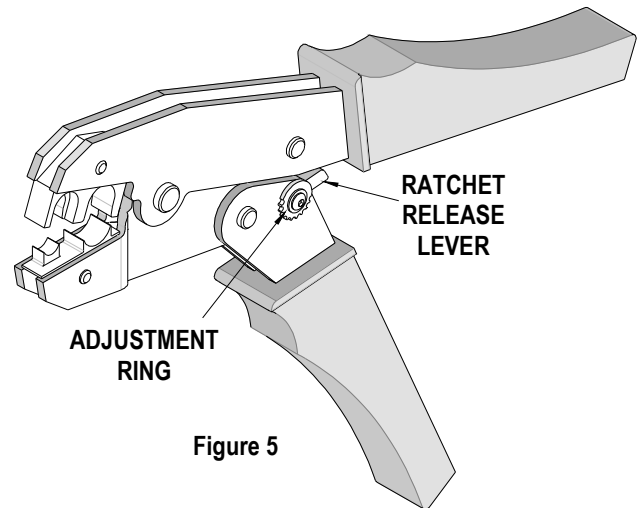

Figure 5

CAUTION: Molex crimp specifications are valid only when used with Molex tooling.

PARTS LIST

Item Number	Order Number	Engineering No.	Description	Quantity
	62100-0200	62100-0200	LFH™ Ferrule Crimp Hand Tool	Figure 6
1	11-31-6379	AM60039-6	Hand Tool Frame	1
2	62100-0201	62100-0201	Die Set Assembly	1
3	N/A	N/A	M4 by 12 Long BHCS	2**

** Available from an industrial supply company such as MSC (1-800-645-7270).

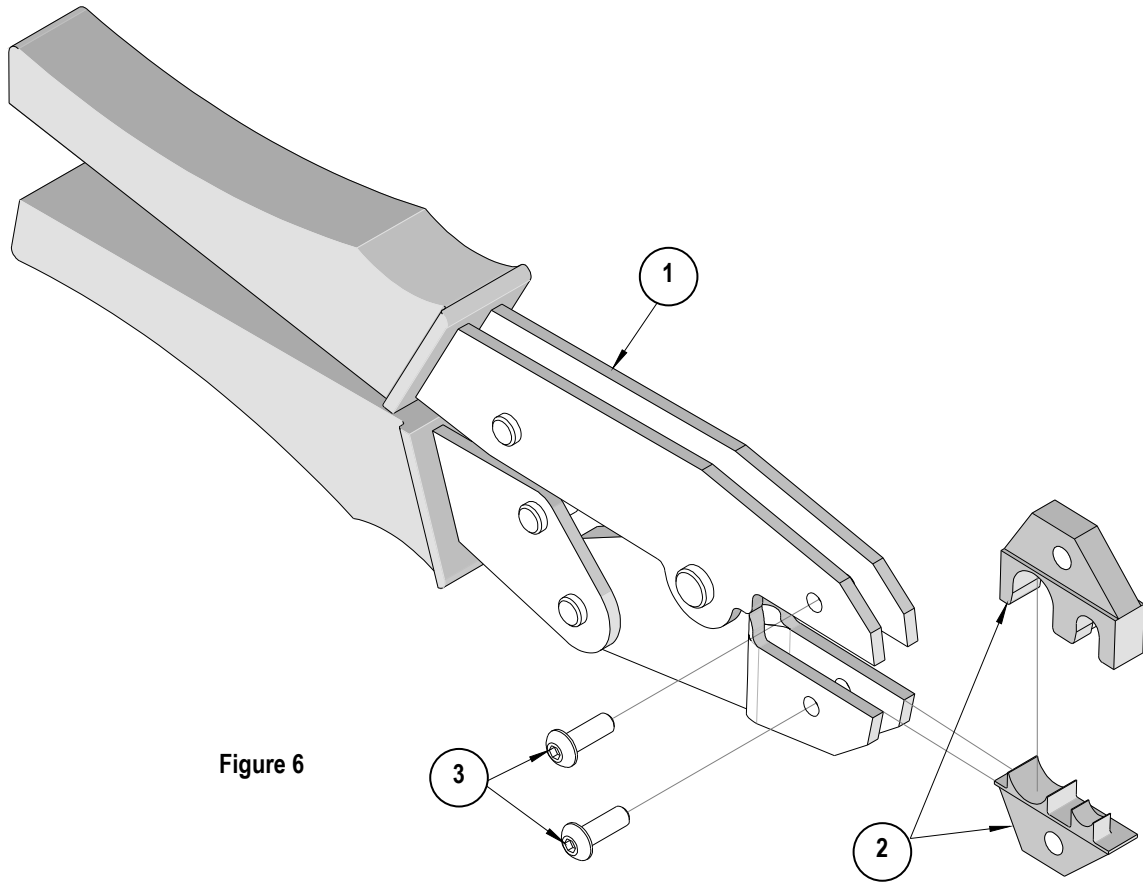

Figure 6

Americas Headquarters
 Lisle, Illinois 60532 U.S.A.
 1-800-78MOLEX
 amerinfo@molex.com

Far East North Headquarters
 Yamato, Kanagawa, Japan
 81-462-65-2324
 feninfo@molex.com

Far East South Headquarters
 Jurong, Singapore
 65-6-268-6868
 fesinfo@molex.com

European Headquarters
 Munich, Germany
 49-89-413092-0
 eurinfo@molex.com

Corporate Headquarters
 2222 Wellington Ct.
 Lisle, IL 60532 U.S.A.
 630-969-4550
 Fax: 630-969-1352

Visit our Web site at <http://www.molex.com>