

15+Gbps 0.5mm pitch Stacking Connectors

FX10 Series Electrical Interface for the OIF 100G Long-Haul DWDM Transmission Module (MSA-100GLH)

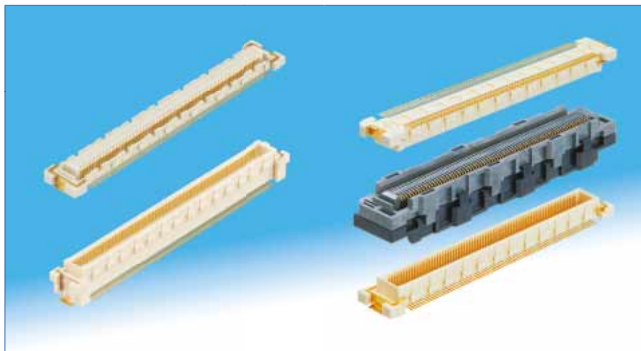

With GND Plate Type

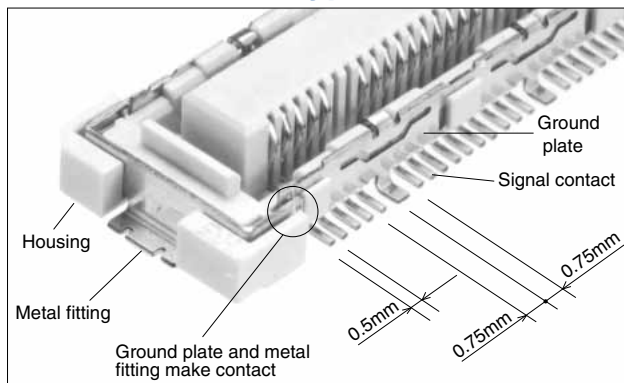

Floating Interposer

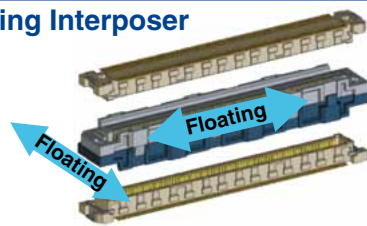

Signal Integrity Features

Insertion-Loss-to-Crosstalk-Ratio(ICR)

The insertion-loss-to-crosstalk-ratio (ICR) with five-aggressor differential FEXT meets the extrapolated IEEE 802.3ap specification for 15+Gbps.

Differential Impedance

85Ω configuration and 100Ω configuration are available.

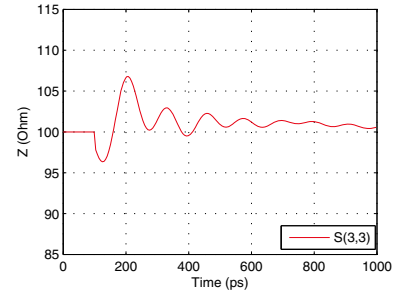
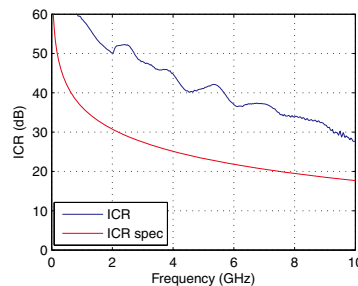

Stack Height

2-piece type

With ground plate

Receptacles	Headers	FX10#-xP/x-SV	FX10#-xP/x-SV1
FX10#-*S/*-SV		4mm	5mm

Without ground plate

Receptacles	Headers	FX10#-xP-SV	FX10#-xP-SV1	FX10#-xP-SV2	FX10#-xP-SV3	FX10#-xP-SV4
FX10#-*S-SV		4mm	5mm	6mm	7mm	8mm

3-piece type

Stacking Height	Header (Mating side)	Interposer	Header(Fixed side)
8mm	FX10#-xP-SV	FX10-xIP-xD(Q)-8H	FX10#-xP-SV
9mm	FX10#-xP-SV		FX10#-xP-SV1
10mm	FX10#-xP-SV1		FX10#-xP-SV1
11mm	FX10#-xP-SV2	FX10-xIP-xD(Q)-8PH	FX10#-xP-SV1
12mm	FX10#-xP-SV3		FX10#-xP-SV1
13mm	FX10#-xP-SV4		FX10#-xP-SV1
			FX10#-xP-SV1

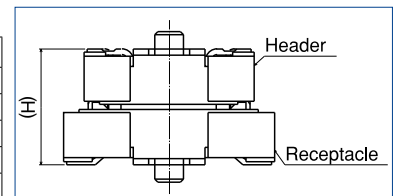

(H) : Reference dimension

Mechanical Features

- 0.5mm Pitch
- Stacking height : 4 to 8mm (2-piece type)
8 to 13mm (3-piece type)

Number of Contacts

With ground plate : 80 / 100 / 120 / 140
Without ground plate : 96 / 120 / 144 / 168
3-piece interposer : 120 / 144 / 168

OIF MSA-100GLH Electrical Interface

FX10A-168P/S-SV(83) assembly is specified for the OIF 100G Long-Haul DWDM Transmission Module host line card - MSA-100GLH electrical connector.



Suited to High-Density Applications

The 0.5 mm signal contact pitch provides a smaller overall connector, using less mounting area on the board.

Optional Ground Plate

An alternate style without the ground plate is available. The space provided by the ground plate removal has been filled with additional signal contacts.
<3-piece type>

- Smooth floating with high speed transmission capability supported by unique 3-piece floating system
- Multiple connectors are allowed on the same PCB (Allowable Mis-alignment Range : ± 0.3mm in XY direction)

General Product Specifications (2 piece type)

Rating	Rated current	0.3 A	Operating temperature range	-55 to 85°C (Note 1)	Storage temperature range	-10 to +60°C (Note 2)
	Rated voltage	50 V AC	Operating humidity range	Relative humidity 95% max (No condensation)	Storage humidity range	40 to 70% (Note 2)
Item	Requirements			Conditions		
1. Insulation resistance	100MΩ min			Measured at 100 V DC		
2. Voltage resistance	No flashover or breakdown			150 V AC applied for 1 minute		
3. Contact resistance	60mΩ max			Measured at 100 mA		
4. Vibration resistance	No electrical discontinuity for 1μs or greater No damage, cracks, or parts looseness			Frequency : 10 to 55 Hz, amplitude of 0.75 mm in 3 axis directions, 10 cycles each.		
5. Shock resistance	No electrical discontinuity for 1μs or greater No damage, cracks, or parts looseness			Acceleration of 490 m/s ² , 11 ms duration, sine half-wave waveform, for 3 cycles in both directions of each of the 3 axes		
6. Damp heat (Steady state)	Contact resistance of 70mΩ max, insulation resistance of 100MΩ min, no damage, cracks, or parts looseness			Temperature of 40°C, humidity of 90 to 95%, duration 96 h		
7. Temperature cycle	Contact resistance of 70mΩ max, insulation resistance of 100MΩ min, no damage, cracks, or parts looseness			Temperature : -55°C → 15 to 35°C → 85°C → 15 to 35°C Time : 30 min. → 2 to 3 min. → 30 min. → 2 to 3 min. for 5 cycles		
8. Mating Cycles	Contact resistance of 70mΩ max No damage, cracks, or parts looseness			50 times		
9. Resistance to soldering heat	No melting of resin portion which affects performance			Reflow : At the recommended temperature profile Soldering iron temperature : 360°C for 5 seconds		

Note 1 : Includes temperature rise caused by current flow.

Note 2 : The term storage refers to unused products kept for a long time prior to board mounting. Operating temperature and humidity range are applicable to the non-conducting state after board assembly.

Note 3 : Information contained in this catalog represents general requirements for this series. Contact us for the drawings and specifications for a specific part number shown.

Materials / Finish

Part	Material	Finish	Notes
Insulator	LCP	Beige	UL94V-0
Contacts	Phosphor bronze	Header	Contact Area: Gold plating Lead Area: Tin plating
		Receptacle	Contact Area: Gold plating Lead Area: Flash plating
Ground plate	Phosphor bronze	Tin plating	_____
Metal fitting	Phosphor bronze	Tin plating	_____

Product Number Structure

Refer to the chart below when determining the product specifications from the product number.

Please select from the product numbers listed in this catalog when placing orders.

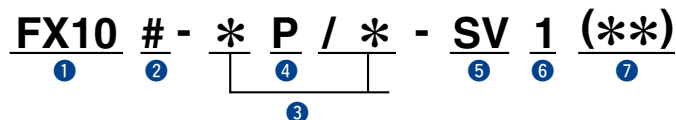

① Series name : FX10	④ Connector type P : Header S : Receptacle
② A : With guide post B : Without guide post	⑤ Mounting style SV : Straight SMT
③ Number of contacts <div style="border: 1px solid black; padding: 2px; display: inline-block;">With ground plate</div> Signal/Ground : 80/8, 100/10, 120/12, 140/14 <div style="border: 1px solid black; padding: 2px; display: inline-block;">Without ground plate</div> Signal : 96, 120, 144, 168	⑥ Product height Blank : Standard 1 : Standard + 1mm
	⑦ Packaging options Blank, (71) : Tray packaging (21), (91) : Embossed tape packaging

Headers without ground plate

4mm Stacking Height

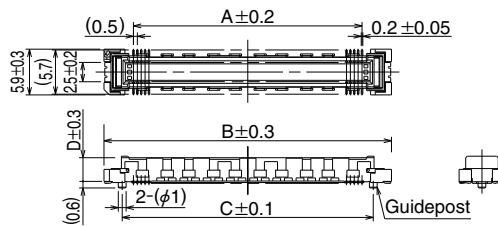
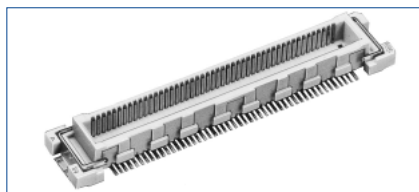

Unit : mm

Part No.	HRS No.	No. of Contacts Signal	A	B	C	D	E	F	Remarks	
										FX10A-96P-SV(**)
FX10A-120P-SV(**)	570-0042-2 **	120	29.5	37.1	32.4	37.5	34.3			
FX10A-144P-SV(**)	570-0043-5 **	144	35.5	43.1	38.4	43.5	40.3			
FX10A-168P-SV(**)	570-0044-8 **	168	41.5	49.1	44.4	4.5	49.5	46.3		
FX10A-96P-SV1(**)	570-0141-4 **	96	23.5	31.1	26.4		31.5	28.3		
FX10A-120P-SV1(**)	570-0142-7 **	120	29.5	37.1	32.4		37.5	34.3		
FX10A-144P-SV1(**)	570-0143-0 **	144	35.5	43.1	38.4	5.25	43.5	40.3		
FX10A-168P-SV1(**)	570-0144-2 **	168	41.5	49.1	44.4		49.5	46.3		
FX10A-120P-SV2(**)	570-0059-5 **	120	29.5	37.1	32.4		37.5	34.3		
FX10A-144P-SV2(**)	570-0056-7 **	144	35.5	43.1	38.4	6.25	43.5	40.3		
FX10A-168P-SV2(**)	570-0302-1 **	168	41.5	49.1	44.4		49.5	46.3		
FX10A-120P-SV3(**)	570-0060-4 **	120	29.5	37.1	32.4		37.5	34.3		
FX10A-144P-SV3(**)	570-0057-0 **	144	35.5	43.1	38.4	7.25	43.5	40.3		
FX10A-168P-SV3(**)	570-0304-7 **	168	41.5	49.1	44.4		49.5	46.3		
FX10A-120P-SV4(**)	570-0061-7 **	120	29.5	37.1	32.4		37.5	34.3		
FX10A-144P-SV4(**)	570-0058-2 **	144	35.5	43.1	38.4	7.25	43.5	40.3		
FX10A-168P-SV4(**)	570-0306-2 **	168	41.5	49.1	44.4		49.5	46.3		
FX10B-96P-SV(**)	570-0051-3 **	96	23.5	31.1	—		3.5	31.5	28.3	Without guideposts
FX10B-120P-SV(**)	570-0052-6 **	120	29.5	37.1	—	37.5		34.3		
FX10B-144P-SV(**)	570-0053-9 **	144	35.5	43.1	—	43.5		40.3		
FX10B-168P-SV(**)	570-0054-1 **	168	41.5	49.1	—	4.5	49.5	46.3		
FX10B-96P-SV1(**)	570-0151-8 **	96	23.5	31.1	—		31.5	28.3		
FX10B-120P-SV1(**)	570-0152-0 **	120	29.5	37.1	—		37.5	34.3		
FX10B-144P-SV1(**)	570-0153-3 **	144	35.5	43.1	—	6.25	43.5	40.3		
FX10B-168P-SV1(**)	570-0154-6 **	168	41.5	49.1	—		49.5	46.3		
FX10B-168P-SV2(**)	570-0303-4 **	168	41.5	49.1	—		5.25	49.5	46.3	
FX10B-168P-SV3(**)	570-0305-0 **	168	41.5	49.1	—	7.25	6.25	49.5	46.3	
FX10B-144P-SV4(**)	570-0063-0 **	144	35.5	43.1	—		7.25	43.5	40.3	
FX10B-168P-SV4(**)	570-0307-5 **	168	41.5	49.1	—		7.25	49.5	46.3	

[Specifications number]-**, (**)
 (71) : Tray packaging / AuP 0.1μm
 (83) : Embossed tape packaging 1RL : 1000pcs / AuP 0.76μm
 (85) : Embossed tape packaging 1RL : 250pcs / AuP 0.76μm
 (91) : Embossed tape packaging 1RL : 1000pcs / AuP 0.1μm
 (93) : Tray packaging / AuP 0.76μm

Note 1: There is no polarity with respect to board mounting for this product.

Note 2: The coplanarity of this product's SMT leads is 0.1mm or less.

Note 3: Please order embossed tape packaged items by the reel.

Recommended PCB Layout Dimensions (Metal mask)

Recommended metal mask thickness : 0.15mm

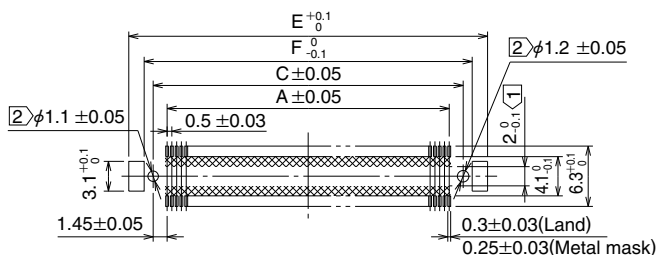

Note ① The cross-hatched area inside the SMT land may come into contact with the connector contacts and thus care should be taken that the pattern does not extend beyond the SMT land width.
 Note ② Not required in products without guideposts.

Board-to-Board Distance

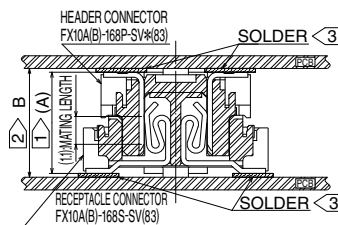

	FX10A(B)-168S-SV(83)	
	① > (A)	② > B
FX10A(B)-168P-SV(83)	4	4.3±0.127
FX10A(B)-168P-SV1(83)	5	5.3±0.127
FX10A(B)-168P-SV2(83)	6	6.0±0.127
FX10A(B)-168P-SV3(83)	7	7.0±0.127
FX10A(B)-168P-SV4(83)	8	8.0±0.127

Note ① Stacking height from lead to lead (reference dimensions)
 Note ② Board-to-board distance
 Note ③ Stencil (metal mask) shall be based on Hirose's recommended aperture and thickness.

■ Receptacles without ground plate

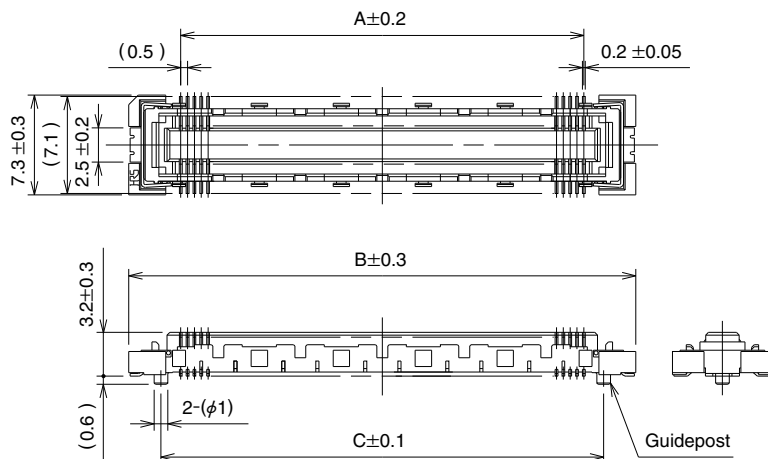

Unit : mm

Part No.	HRS No.	No. of Contacts	A	B	C	D	E	Remarks
		Signal						
FX10A-96S-SV(**)	570-0241-9 **	96	23.5	31.1	26.4	31.5	28.3	With guideposts
FX10A-120S-SV(**)	570-0242-1 **	120	29.5	37.1	32.4	37.5	34.3	
FX10A-144S-SV(**)	570-0243-4 **	144	35.5	43.1	38.4	43.5	40.3	
FX10A-168S-SV(**)	570-0244-7 **	168	41.5	49.1	44.4	49.5	46.3	
FX10B-96S-SV(**)	570-0251-2 **	96	23.5	31.1	26.4	31.5	28.3	Without guideposts
FX10B-120S-SV(**)	570-0252-5 **	120	29.5	37.1	32.4	37.5	34.3	
FX10B-144S-SV(**)	570-0253-8 **	144	35.5	43.1	38.4	43.5	40.3	
FX10B-168S-SV(**)	570-0254-0 **	168	41.5	49.1	44.4	49.5	46.3	

[Specifications number] - **, (**)
 Blank: Tray packaging / AuP 0.1μm
 (21) : Embossed tape packaging 1RL : 1000pcs / AuP 0.1μm
 (83) : Embossed tape packaging 1RL : 1000pcs / AuP 0.76μm
 (84) : Embossed tape packaging 1RL : 500pcs / AuP 0.76μm
 (85) : Embossed tape packaging 1RL : 250pcs / AuP 0.76μm
 (93) : Tray packaging / AuP 0.76μm

- Note 1 : There is no polarity with respect to board mounting for this product.
- Note 2 : The coplanarity of this product's SMT leads is 0.1mm or less.
- Note 3 : Please order embossed tape packaged items by the reel.
- Note 4 : Using multiple connectors between two boards is not recommended.

◆ Recommended PCB Layout Dimensions (Metal mask)

Recommended metal mask thickness : 0.15mm

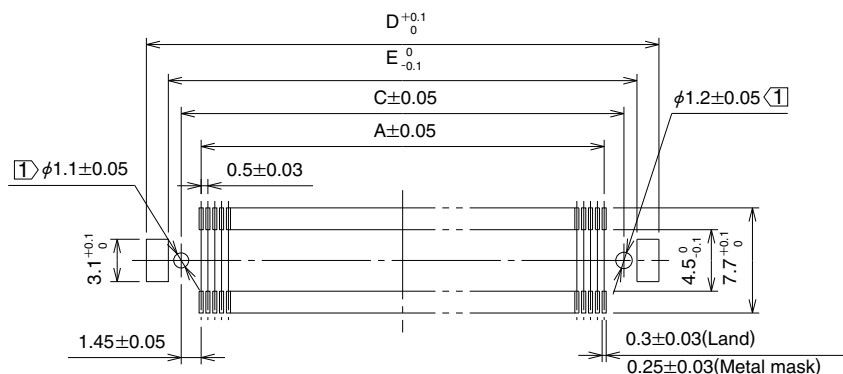

Note 1) Not required in products without guideposts.

■ Headers with ground plate

● 4mm Stacking Height

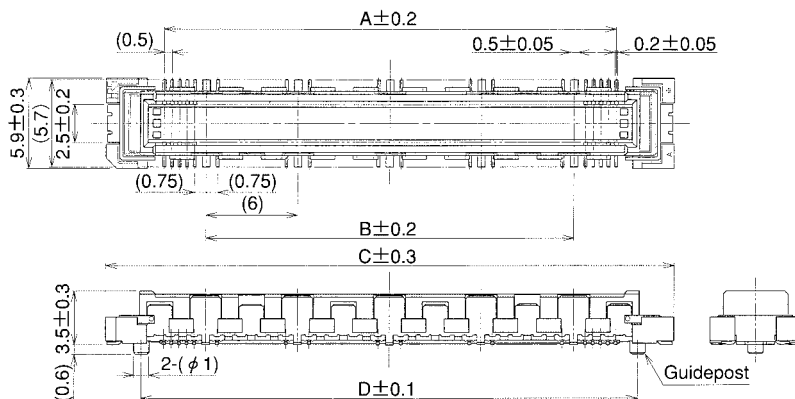

Unit : mm

Part No.	HRS No.	No. of Contacts		A	B	C	D	E	F	Remarks
		Signal	Ground							
FX10A-80P/8-SV(**)	570-0001-5 **	80	8	23.5	18	31.1	26.4	31.5	28.3	With guideposts
FX10A-100P/10-SV(**)	570-0002-8 **	100	10	29.5	24	37.1	32.4	37.5	34.3	
FX10A-120P/12-SV(**)	570-0003-0 **	120	12	35.5	30	43.1	38.4	43.5	40.3	
FX10A-140P/14-SV(**)	570-0004-3 **	140	14	41.5	36	49.1	44.4	49.5	46.3	
FX10B-80P/8-SV(**)	570-0021-2 **	80	8	23.5	18	31.1	—	31.5	28.3	Without guideposts
FX10B-100P/10-SV(**)	570-0022-5 **	100	10	29.5	24	37.1	—	37.5	34.3	
FX10B-120P/12-SV(**)	570-0023-8 **	120	12	35.5	30	43.1	—	43.5	40.3	
FX10B-140P/14-SV(**)	570-0024-0 **	140	14	41.5	36	49.1	—	49.5	46.3	

[Specifications number] - **, (**)
 (71) : Tray packaging
 (91) : Embossed tape packaging

- Note 1 : There is no polarity with respect to board mounting for this product.
- Note 2 : The coplanarity of this product's SMT leads is 0.1mm or less.
- Note 3 : Please order embossed tape packaged items by the reel. (One reel holds 1,000 pieces.)
- Note 4 : Using multiple connectors between identical boards is not recommended.

◆ Recommended PCB Layout Dimensions (Metal mask)

Recommended metal mask thickness : 0.15mm



- Note 1) Cross-hatched portions, totaling n places, indicate the ground circuits.
- Note 2) Cross-hatched portions, 2 places on both sides, indicate the metal fittings.
- Note 3) The cross-hatched area inside the SMT land may come into contact with the connector contacts and thus care should be taken that the pattern does not extend beyond the SMT land width.
- Note 4) Not required in products without guideposts.

■ Headers with ground plate

● 5mm Stacking Height

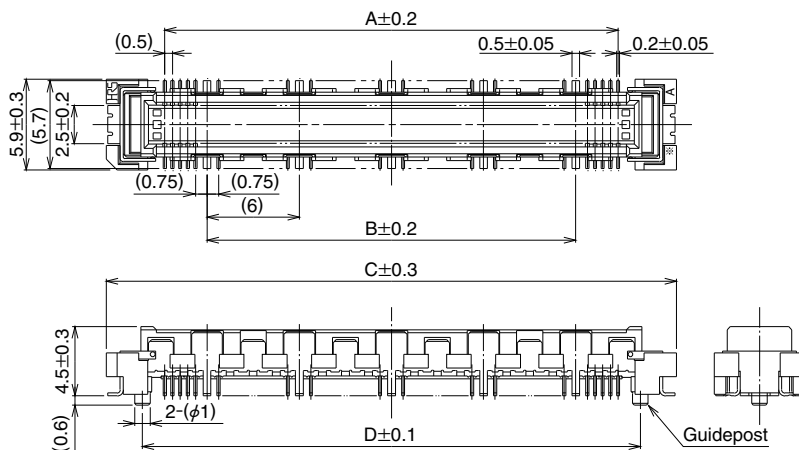

Unit : mm

Part No.	HRS No.	No. of Contacts		A	B	C	D	E	F	Remarks
		Signal	Ground							
FX10A-80P/8-SV1(**)	570-0101-0 **	80	8	23.5	18	31.1	26.4	31.5	28.3	With guideposts
FX10A-100P/10-SV1(**)	570-0102-2 **	100	10	29.5	24	37.1	32.4	37.5	34.3	
FX10A-120P/12-SV1(**)	570-0103-5 **	120	12	35.5	30	43.1	38.4	43.5	40.3	
FX10A-140P/14-SV1(**)	570-0104-8 **	140	14	41.5	36	49.1	44.4	49.5	46.3	
FX10B-80P/8-SV1(**)	570-0121-7 **	80	8	23.5	18	31.1	—	31.5	28.3	Without guideposts
FX10B-100P/10-SV1(**)	570-0122-0 **	100	10	29.5	24	37.1	—	37.5	34.3	
FX10B-120P/12-SV1(**)	570-0123-2 **	120	12	35.5	30	43.1	—	43.5	40.3	
FX10B-140P/14-SV1(**)	570-0124-5 **	140	14	41.5	36	49.1	—	49.5	46.3	

[Specifications number] - **, (**)
 (71) : Tray packaging
 (91) : Embossed tape packaging

- Note 1 : There is no polarity with respect to board mounting for this product.
- Note 2 : The coplanarity of this product's SMT leads is 0.1mm or less.
- Note 3 : Please order embossed tape packaged items by the reel. (One reel holds 1,000 pieces.)
- Note 4 : Using multiple connectors between identical boards is not recommended.

◆ Recommended PCB Layout Dimensions (Metal mask)

Recommended metal mask thickness : 0.15mm

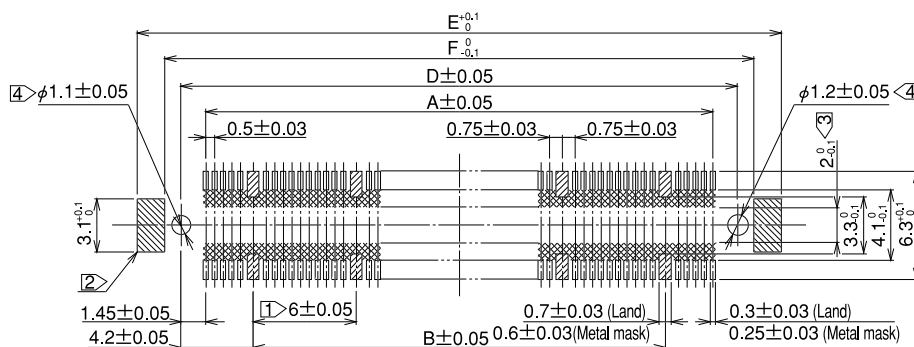

- Note 1) Cross-hatched portions, totaling n places, indicate the ground circuits.
- Note 2) Cross-hatched portions, 2 places on both sides, indicate the metal fittings.
- Note 3) The cross-hatched area inside the SMT land may come into contact with the connector contacts and thus care should be taken that the pattern does not extend beyond the SMT land width.
- Note 4) Not required in products without guideposts.

Receptacles with ground plate

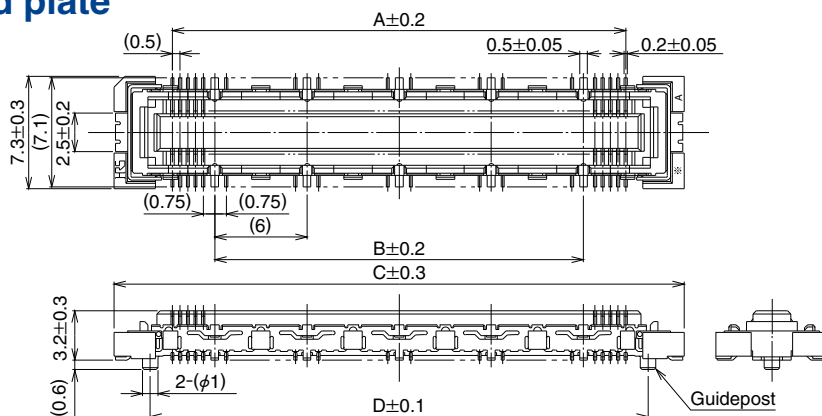

Unit : mm

Part No.	HRS No.	No. of Contacts		A	B	C	D	E	F	Remarks
		Signal	Ground							
FX10A-80S/8-SV(**)	570-0201-4 **	80	8	23.5	18	31.1	26.4	31.5	28.3	With guideposts
FX10A-100S/10-SV(**)	570-0202-7 **	100	10	29.5	24	37.1	32.4	37.5	34.3	
FX10A-120S/12-SV(**)	570-0203-0 **	120	12	35.5	30	43.1	38.4	43.5	40.3	
FX10A-140S/14-SV(**)	570-0204-2 **	140	14	41.5	36	49.1	44.4	49.5	46.3	
FX10B-80S/8-SV(**)	570-0221-1 **	80	8	23.5	18	31.1	—	31.5	28.3	Without guideposts
FX10B-100S/10-SV(**)	570-0222-4 **	100	10	29.5	24	37.1	—	37.5	34.3	
FX10B-120S/12-SV(**)	570-0223-7 **	120	12	35.5	30	43.1	—	43.5	40.3	
FX10B-140S/14-SV(**)	570-0224-0 **	140	14	41.5	36	49.1	—	49.5	46.3	

[Specifications number] - **, (**)
 (71) : Tray packaging
 (91) : Embossed tape packaging

- Note 1 : There is no polarity with respect to board mounting for this product.
- Note 2 : The coplanarity of this product's SMT leads is 0.1mm or less.
- Note 3 : Please order embossed tape packaged items by the reel. (One reel holds 1,000 pieces.)

Recommended PCB Layout Dimensions (Metal mask)

Recommended metal mask thickness : 0.15mm

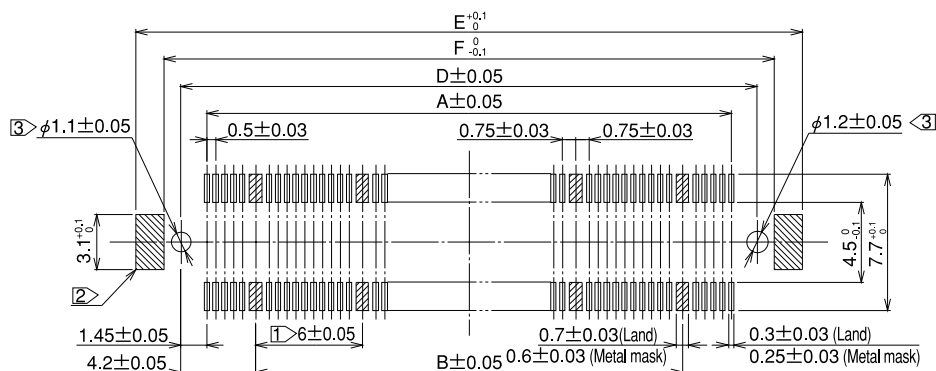

- Note ① Cross-hatched portions, totaling n places, indicate the ground circuits.
- Note ② Cross-hatched portions, 2 places on both sides, indicate the metal fittings.
- Note ③ Not required in products without guideposts.

General Product Specifications (3 piece type)

Rating	Rated current	0.3A	Operating temperature range	-55 to 85°C (Note 1)	Storage temperature range	-10 to +60°C (Note 2)
	Rated voltage	50V AC	Operating humidity range	Relative humidity 95% max (No condensation)	Storage humidity range	40 to 70% (Note 2)

Item	Requirements	Conditions
1. Insulation resistance	100MΩ min	Measured at 100 V DC
2. Voltage resistance	No flashover or breakdown	150 V AC applied for 1 minute
3. Contact resistance	8mm height : 80mΩ max 9mm height : 85mΩ max 10mm height : 90mΩ max 11mm height : 95mΩ max 12mm height : 100mΩ max 13mm height : 105mΩ max	Measured at 100 mA
4. Vibration resistance	No electrical discontinuity for 1μs or greater No damage, cracks, or parts looseness	Frequency : 10 to 55 Hz, amplitude of 0.75mm in 3 axis directions, 10 cycles each.
5. Shock resistance	No electrical discontinuity for 1μs or greater No damage, cracks, or parts looseness	Acceleration of 490m/s ² , 11ms duration, sine half-wave waveform, for 3 cycles in both directions of each of the 3 axes
6. Damp heat (Steady state)	Contact resistance change : 20 mΩ or less, insulation resistance of 100MΩ min, no damage, cracks, or parts looseness	Temperature of 40°C, humidity of 90 to 95%, duration 96 h
7. Temperature cycle	Contact resistance change : 20mΩ or less, insulation resistance of 100MΩ min, no damage, cracks, or parts looseness	Temperature : -55°C → 15 to 35°C → 85°C → 15 to 35°C Time : 30 min. → 2 to 3 min. → 30 min. → 2 to 3 min. for 5 cycles
8. Mating Cycles	Contact resistance change : 20mΩ or less No damage, cracks, or parts looseness	50 times

Note 1 : Includes temperature rise caused by current flow.

Note 2 : The term storage refers to unused products kept for a long time prior to board mounting. Operating temperature and humidity range are applicable to the non-conducting state after board assembly.

Note 3 : Information contained in this catalog represents general requirements for this series. Contact us for the drawings and specifications for a specific part number shown.

Materials / Finish

Part	Material	Finish	Notes
Insulator	LCP	Black/Gray	UL94V-0
Contacts	Phosphor bronze	Contact Area: Gold plating	————
Ground bar	Phosphor bronze	Ni plating	————

Product Number Structure

Refer to the chart below when determining the product specifications from the product number. Please select from the product numbers listed in this catalog when placing orders.

FX10 - # IP - 36 DM1 - #H (#)

①
②
③
④
⑤
⑥
⑦
⑧

① Series Name : FX10	⑥ Pin configuration Blank = Standard (all diff pairs), M* =Reduced GND pins
② Pin count : 120, 144, 168 pins	
③ Connector type IP : Interposer	⑦ Stacking height 8H : 8 to 10mm 8PH : 11 to 13mm
④ Number of Diff-pairs	
⑤ Signal type D : Diff. 100 ohm Q : Diff. 85 ohm (Blank) : Open pin field	⑧ Specification suffix # (Blank) : Ni1.5μm + Au0.1μm (03) : Ni1.5μm + Au0.76μm

Interposer (3piece type)



Unit : mm

Part No.	HRS No.	Signal type	Differential pairs	Single-ended pins	Ground pins	A	Remarks
FX10-168IP-40D-8H(**)	608-0001-3 **	100Ω	40	4	84	49.1	For 8 to 10mm height
FX10-168IP-40D-8PH(**)	608-0004-1 **						For 11 to 13mm height
FX10-168IP-52Q-8H(**)	608-0002-6 **	85Ω	52	8	56		For 8 to 10mm height
FX10-168IP-52Q-8PH(**)	608-0005-4 **						For 11 to 13mm height
FX10-168IP-8H(**)	608-0003-9 **	Open pin field	0	168	0		For 8 to 10mm height
FX10-168IP-8PH(**)	608-0006-7 **						For 11 to 13mm height
FX10-144IP-32D-8H(**)	608-0007-0 **	100Ω	32	12	68	43.1	For 8 to 10mm height
FX10-144IP-32D-8PH(**)	608-0011-7 **						For 11 to 13mm height
FX10-144IP-44Q-8H(**)	608-0008-2 **	85Ω	44	8	48		For 8 to 10mm height
FX10-144IP-44Q-8PH(**)	608-0010-4 **						For 11 to 13mm height
FX10-144IP-8H(**)	608-0009-5 **	Open pin field	0	144	0		For 8 to 10mm height
FX10-144IP-8PH(**)	608-0012-0 **						For 11 to 13mm height
FX10-120IP-28D-8H(**)	608-0013-2 **	100Ω	28	4	60	37.1	For 8 to 10mm height
FX10-120IP-28D-8PH(**)	608-0014-5 **						For 11 to 13mm height
FX10-120IP-36Q-8H(**)	608-0015-8 **	85Ω	36	8	40		For 8 to 10mm height
FX10-120IP-36Q-8PH(**)	608-0016-0 **						For 11 to 13mm height
FX10-120IP-8H(**)	608-0017-3 **	Open pin field	0	120	0		For 8 to 10mm height
FX10-120IP-8PH(**)	608-0018-6 **						For 11 to 13mm height

[Specifications number] -*, (**)
 Blank : Contact plating Ni1.5μm+Au0.1μm
 (03) : Contact plating Ni1.5μm+Au0.76μm

Stacking height	Header (Mating side)	Interposer	Header (Fixed side)
8mm	FX10#-xP-SV	FX10-xIP-xD(Q)-8H	FX10#-xP-SV
9mm	FX10#-xP-SV		FX10#-xP-SV1
10mm	FX10#-xP-SV1		FX10#-xP-SV1
11mm	FX10#-xP-SV2	FX10-xIP-xD(Q)-8PH	FX10#-xP-SV1
12mm	FX10#-xP-SV3		FX10#-xP-SV1
13mm	FX10#-xP-SV4		FX10#-xP-SV1

Signal integrity (2 piece type)

Pin assignment

To match 100 ohm differential impedance and to reduce crosstalk, a staggered GSGSG pin assignment is recommended. (G=ground and S=signal)



Impedance

The differential impedance is 100 +/- 10 ohm for FX10 at 30 ps rise time (20% to 80%).

4mm (without GND)

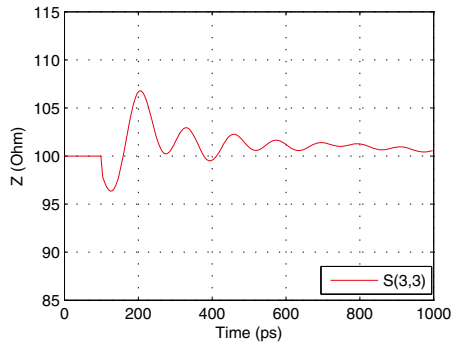

5mm (without GND)

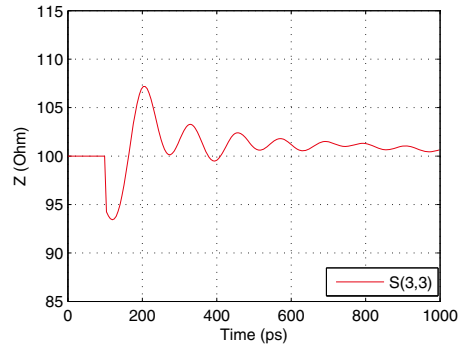

4mm (with GND)

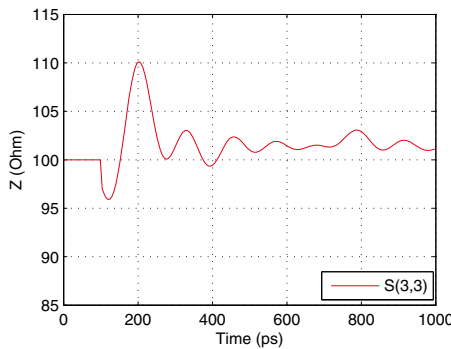

5mm (with GND)

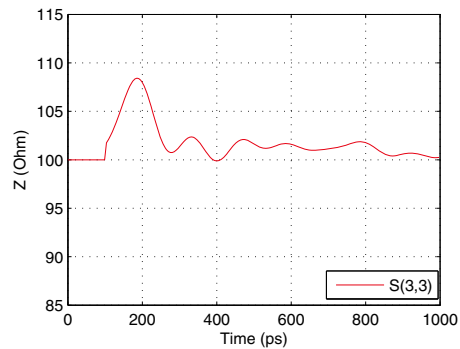

Propagation delay

The propagation delay is 62 and 67 ps for FX10 of 4mm and 5mm height (with and without GND), respectively.

● Insertion loss

The differential insertion loss crosses 1dB at 10.8 and 9.2GHz for FX10 of 4mm and 5mm height, respectively.

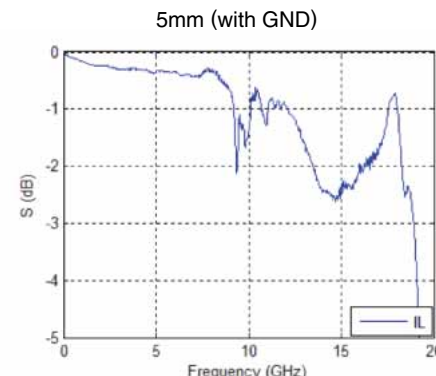
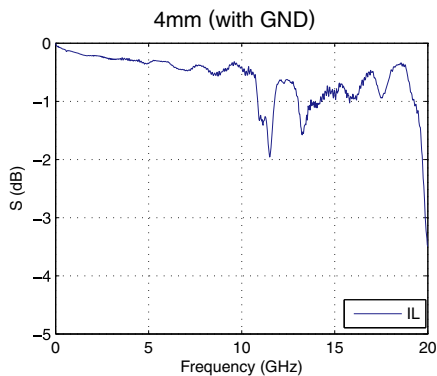
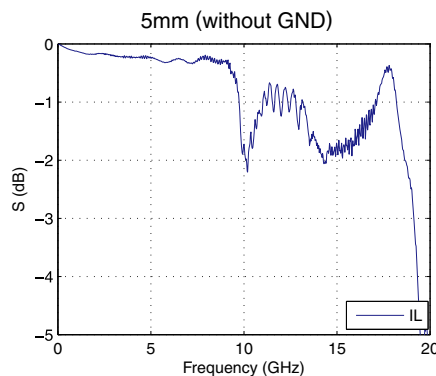
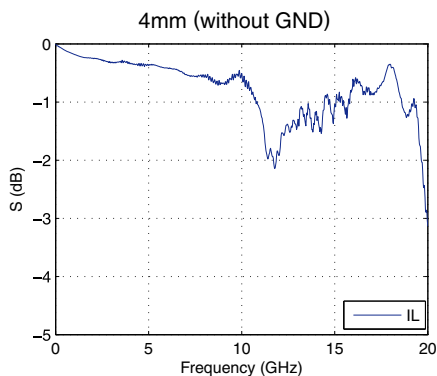

● Return loss

The differential return loss meets the IEEE 802.3ap specification to 20+ and 13.5 GHz for FX10 of 4mm and 5mm height, respectively.

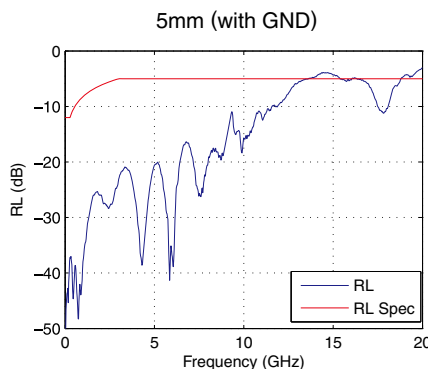
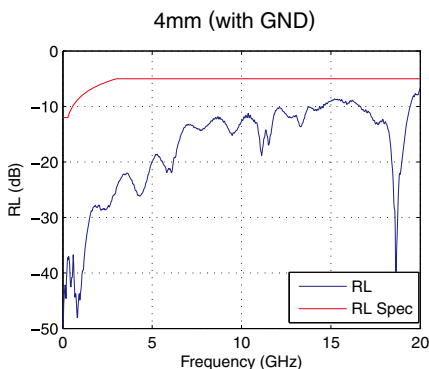
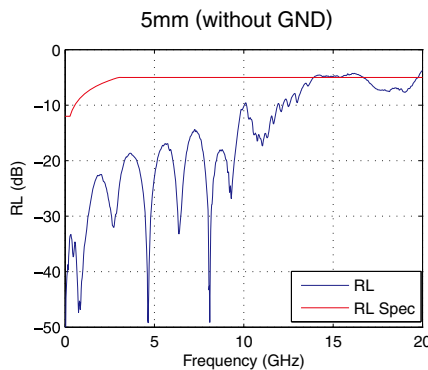
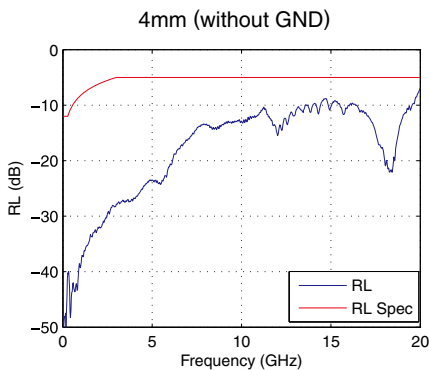

● **Near-end crosstalk (NEXT)**

The staggered GSGSG pin assignment results in low differential NEXT between neighboring pairs.

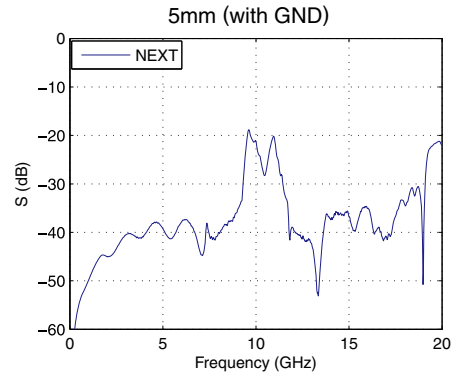
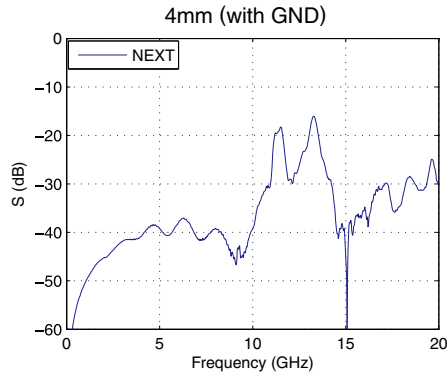
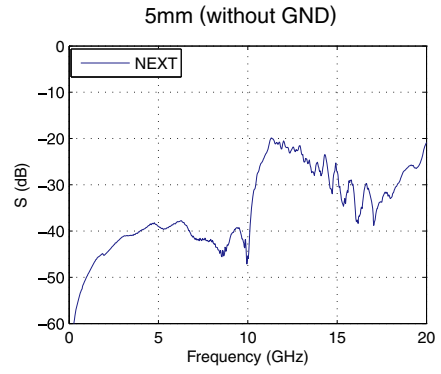
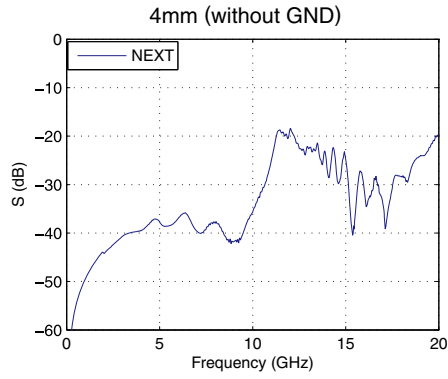

● **Far-end crosstalk (FEXT)**

The staggered GSGSG pin assignment results in low differential FEXT between neighboring pairs.

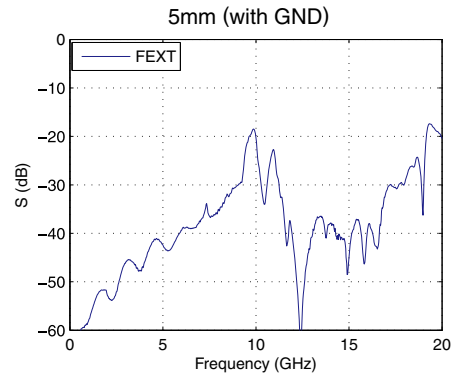
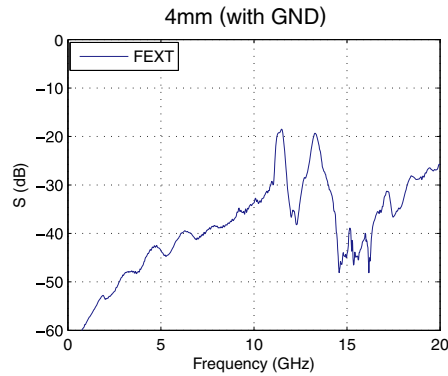
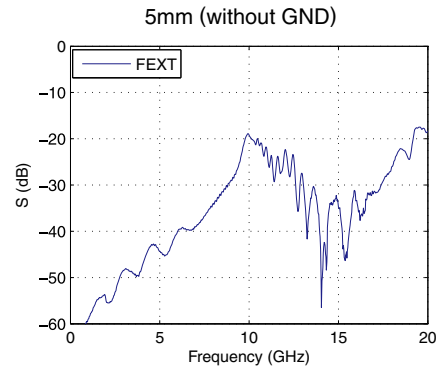
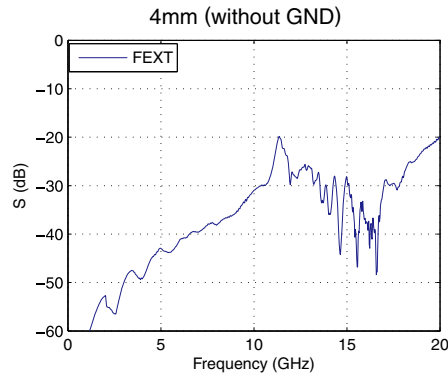

● Insertion-loss-to-crosstalk ratio (ICR)

The insertion-loss-to-crosstalk ratio (ICR) with five-aggressor differential FEXT meets the extrapolated IEEE 802.3ap specification to 10+ Gbps.

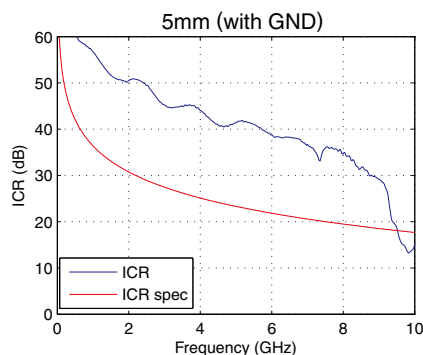
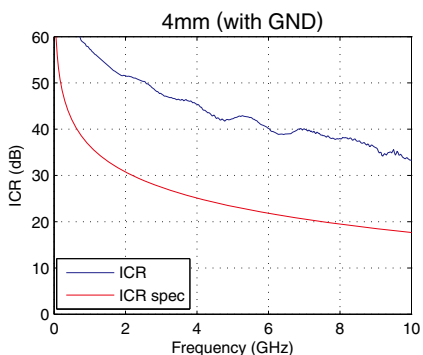
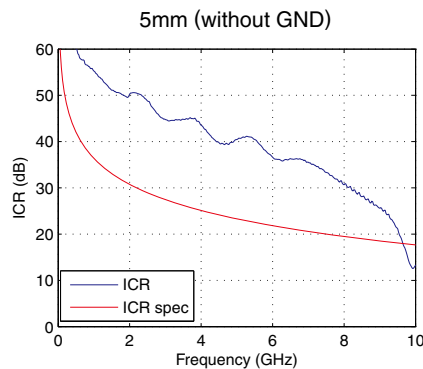
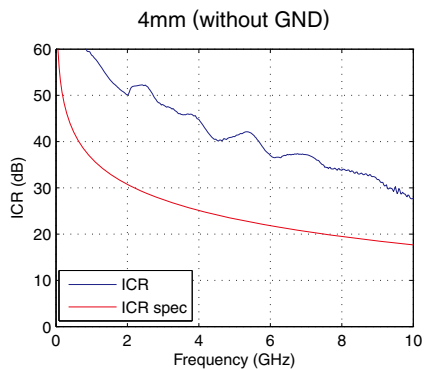

Signal integrity (3-piece type)

Pin assignment

For 100 ohm type interposer, pin assignment shall be GSGSG.

For 85 ohm type interposer, pin assignment shall be GSSG.

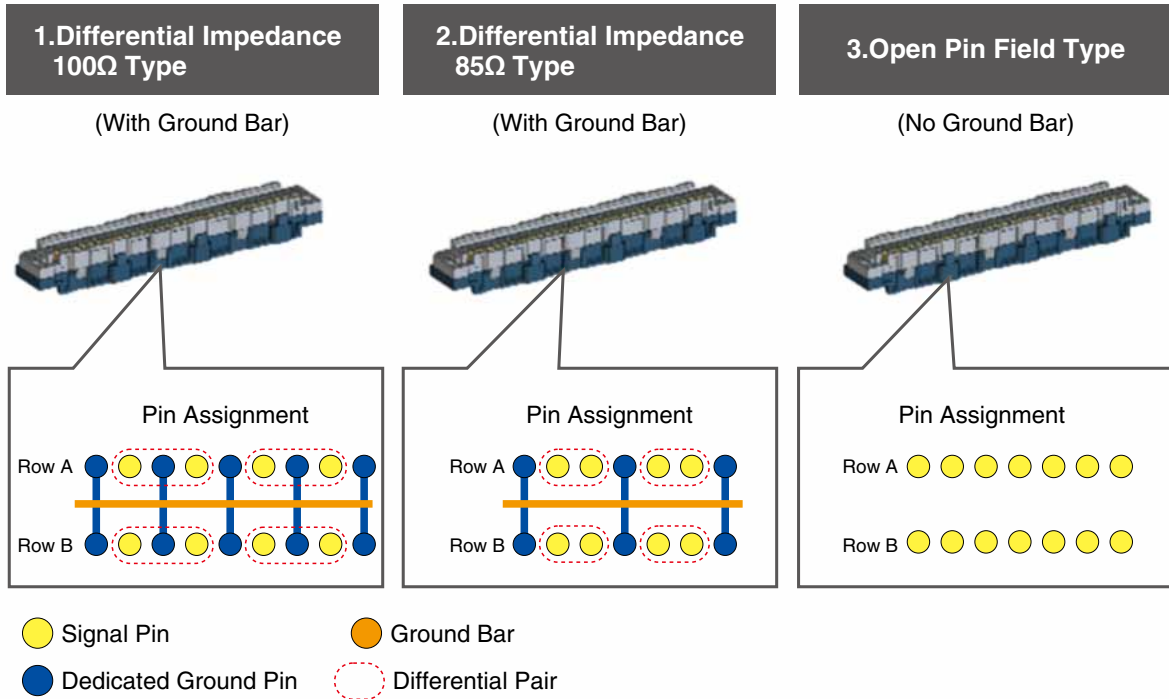

Impedance

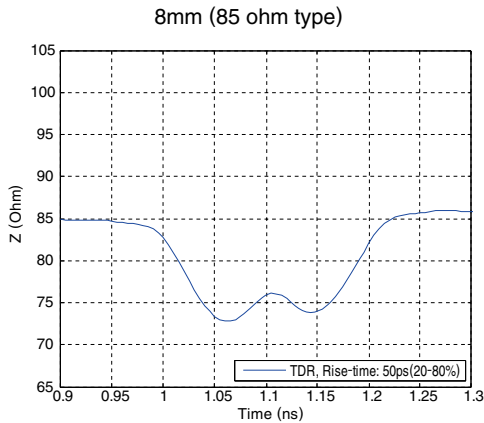

Insertion Loss

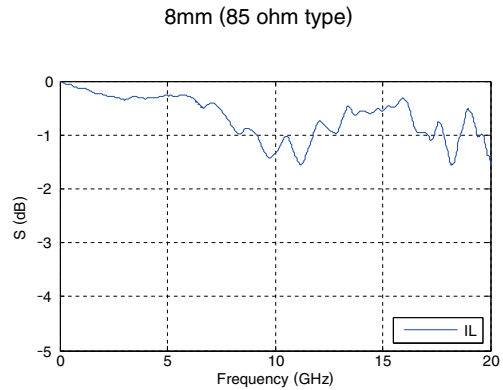

Return Loss

The differential return loss meets the IEEE 802.3ap specification to 20+GHz for FX10 of 8mm height.

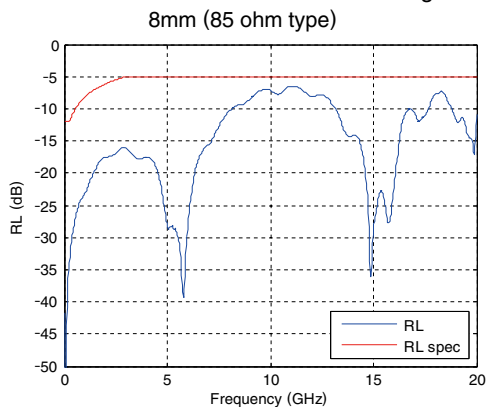

● Near-end crosstalk (NEXT)

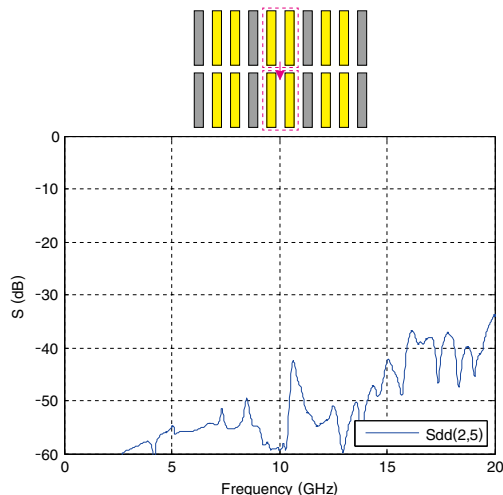
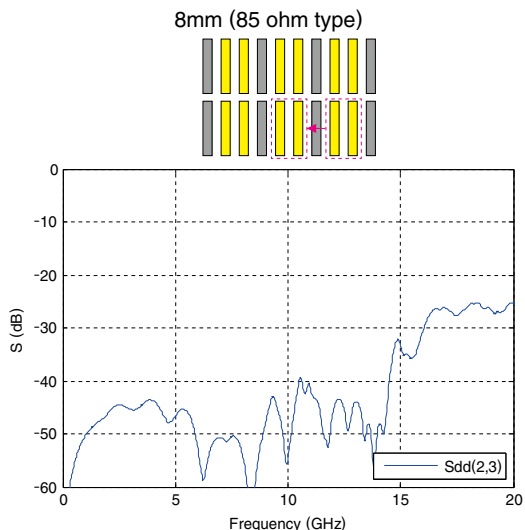

● Far-end crosstalk (FEXT)

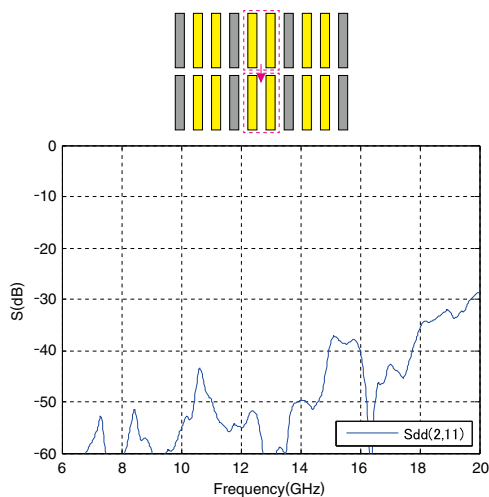
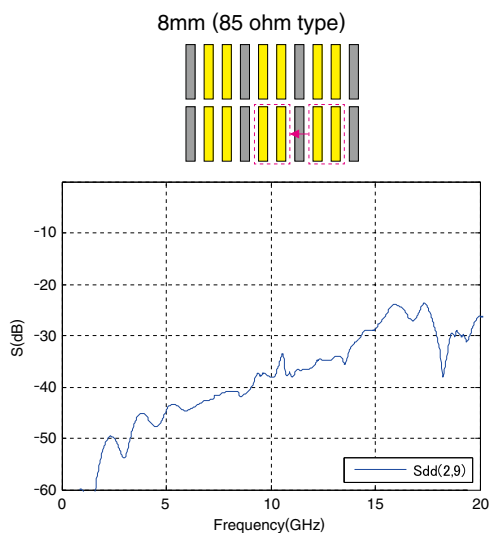

● Insertion-loss-to-crosstalk ratio (ICR)

The insertion-loss-to-crosstalk ratio (ICR) with five-aggressor differential FEXT meets the extrapolated IEEE 802.3ap specification to 15+Gbps.

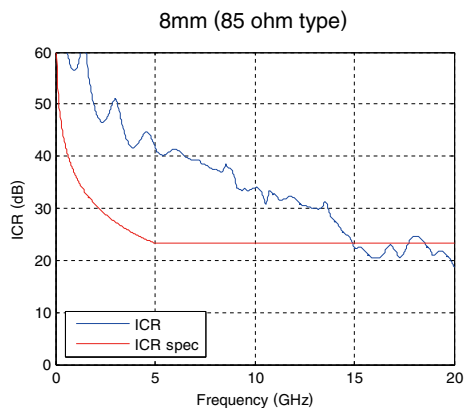

◆ Embossed Carrier Tape Dimensions

● Headers

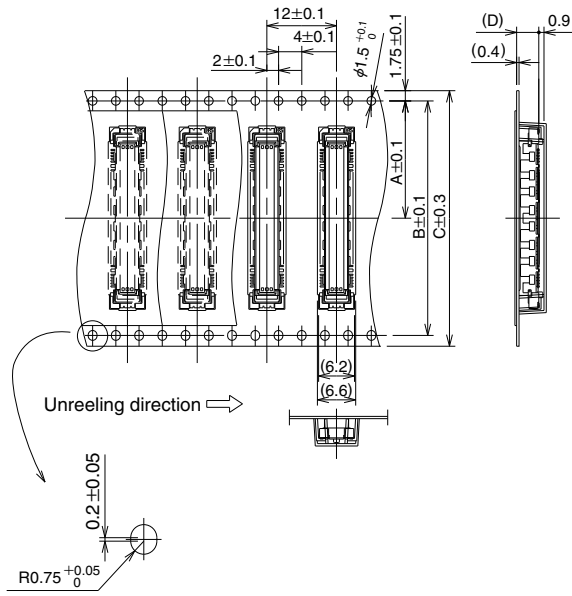

Unit : mm

Insertion Connector	A	B	C	D	E	F	G
FX10#-80P/8-SV	20.2	40.4	44	3.8	45.5	50.5	330
FX10#-100P/10-SV	26.2	52.4	56		59	64	
FX10#-120P/12-SV					76.5	81.5	
FX10#-140P/14-SV	34.2	68.4	72		45.5	50.5	
FX10#-96P-SV	20.2	40.4	44		59	64	
FX10#-120P-SV	26.2	52.4	56		76.5	81.5	
FX10#-144P-SV	34.2	68.4	72		45.5	50.5	
FX10#-168P-SV	20.2	40.4	44		59	64	
FX10#-80P/8-SV1	20.2	40.4	44	4.8	45.5	50.5	370
FX10#-100P/10-SV1	26.2	52.4	56		59	64	
FX10#-120P/12-SV1					76.5	81.5	
FX10#-140P/14-SV1	34.2	68.4	72		45.5	50.5	
FX10#-96P-SV1	20.2	40.4	44		59	64	
FX10#-120P-SV1	26.2	52.4	56		76.5	81.5	
FX10#-144P-SV1	34.2	68.4	72		45.5	50.5	
FX10#-168P-SV1	20.2	40.4	44		59	64	

● Receptacles

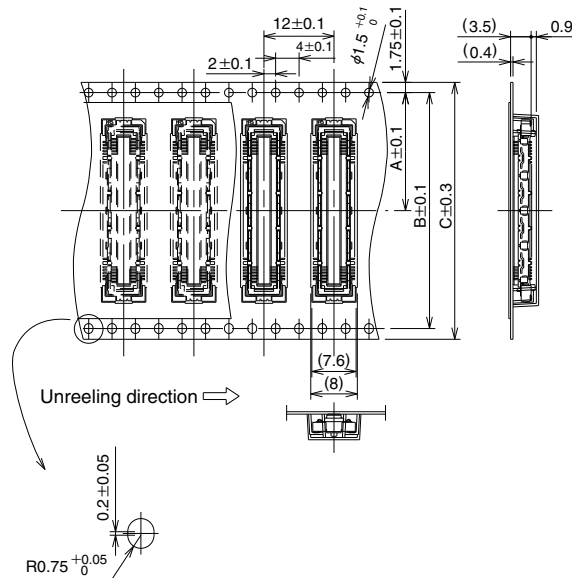

Unit : mm

Insertion Connector	A	B	C	E	F	G
FX10#-80S/8-SV	20.2	40.4	44	45.5	50.5	330
FX10#-100S/10-SV	26.2	52.4	56	59	64	
FX10#-120S/12-SV				76.5	81.5	
FX10#-140S/14-SV	34.2	68.4	72	45.5	50.5	
FX10#-96S-SV	20.2	40.4	44	59	64	
FX10#-120S-SV	26.2	52.4	56	76.5	81.5	
FX10#-144S-SV	34.2	68.4	72	45.5	50.5	
FX10#-168S-SV	20.2	40.4	44	59	64	

Note : There is no polarity with respect to embossed tape packaging for this product.

● Reel Dimensions

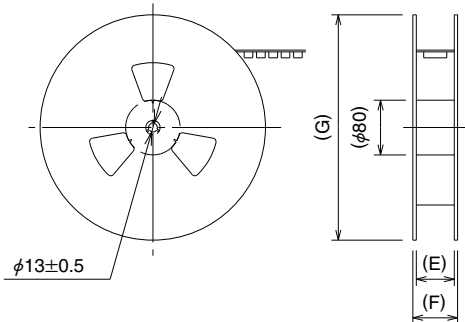

◆ Recommended Temperature Profile

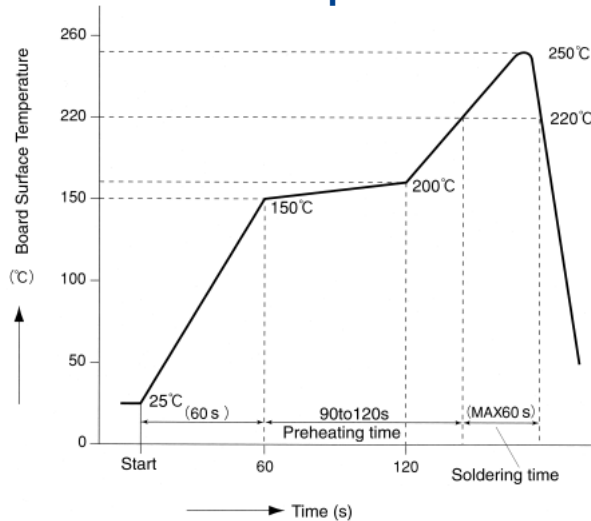

HRS test Conditions

Test board Glass epoxy 161mm×100mm×1.6mm thick
 Solder method : Reflow
 Solder composition : Paste, 96.5%Sn/3%Ag/0.5%Cu
 Metal mask : 0.15mm thick
 Reflow cycles : 2 cycles

The temperature profile is based on the above conditions. In individual applications the actual temperature may vary, depending on solder paste type, volume/thickness and board size/thickness. Consult your solder paste and equipment manufacturer for specific recommendations.

◆ Washing Conditions

Organic Solvent Cleaning

Solvent	Room temperature washing	Heated washing
IPA (Isopropyl alcohol)	○	○
HCFC (Hydrochlorofluorocarbon)	○	○

Water Type Cleaning

When using water based cleaning agents (e.g., terpene, alkali saponifiers) make sure the labeling discloses any effect on metals, platings and plastics. Remove any moisture after cleaning. Residual flux or cleaning agents in the contact areas may affect the electrical performance.

Cleaning Precautions

Residual flux or cleaning agents in the contact areas may affect the electrical performance. Please make sure a thorough cleaning operation has been completed.

◆ Connector Handling Precautions

1. Mating lengths and creepage distance

The effective wipe length for this product is 1.1mm for the signal contact and 1 mm for the ground contact. Creepage of the header and receptacle during mating should be within 0.5 mm of the fully mated position.

2. PCB support

Note that boards should not be supported solely by the connectors themselves. Support should be in the form of spacers and screws or other suitable methods to support the boards.

3. Solder repairs

During repair, the flux could wick onto the contact area of the connector and cause reduced contact reliability. In this case, make sure you understand washing conditions before washing is implemented.

4. Miscellaneous

- Note that excessive twisting while inserting or withdrawing connectors will cause damage.

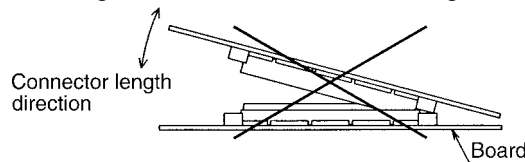
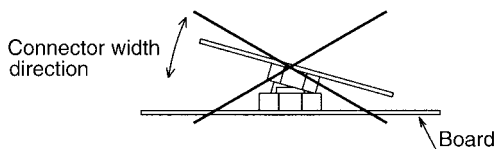

- Slight color differences on the molded items may be noted. However, these color differences will not affect the connector's performance.

Spacer

Spacers are required to support the PWB's and protect the SMT solder joints.

Suggested spacer style is shown below:

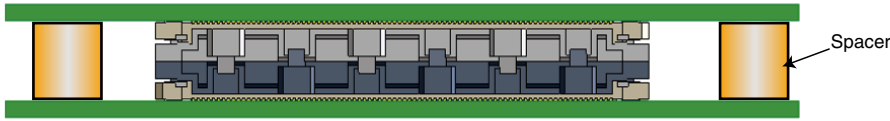

Spacer, male-male, M3 thread

The recommended spacer height corresponds to the interposer stacking height as shown in the chart below.

Stacking height	Recommended spacer height	Remark
4mm	4.3 ± 0.127mm	2 piece type
5mm	5.3 ± 0.127mm	
6mm	6 ± 0.127mm	
7mm	7 ± 0.127mm	
8mm	8 ± 0.127mm	
8mm	8 ± 0.127mm	3 piece type
9mm	9 ± 0.127mm	
10mm	10 ± 0.127mm	
11mm	11 ± 0.127mm	
12mm	12 ± 0.127mm	
13mm	13 ± 0.127mm	

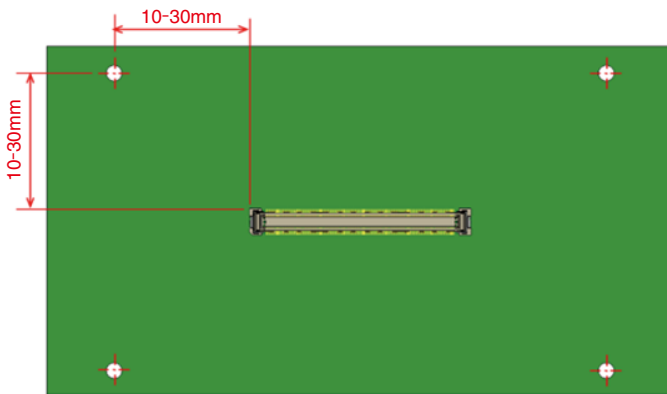

Recommended spacer location

Four spacers located diagonally are required. Spacers should be located 10 to 30mm from the connector to prevent excessive mechanical loading on the interconnections. If assembly will be subjected to vibration, spacer should be located to prevent resonance, and additional spacer may be required.

Interposer installation

Position the interposer directly over the mounting header. (Interposers have no polarity.) Fixed side (black side) of the interposer shall be mated with the mounting header (fixed side). Do not use SV2, SV3, or SV4 headers on both sides of the interposer. The wiping length on the mating side becomes shorter.

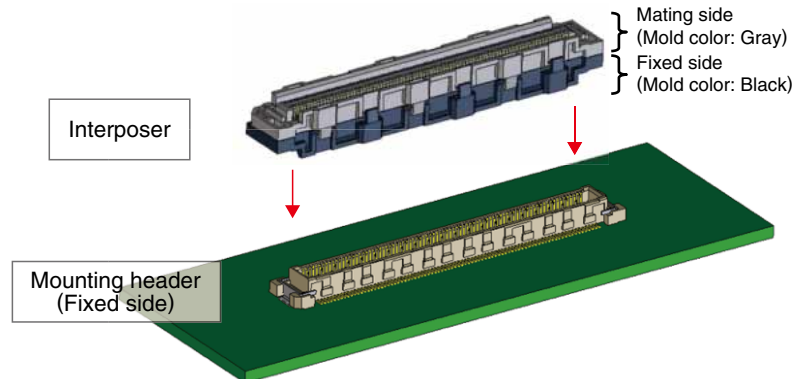

Stacking height	Header (Mating side)	Interposer	Header (Fixed side)
8mm	FX10#-xP-SV	FX10-xIP-xD(Q)-8H	FX10#-xP-SV
9mm	FX10#-xP-SV		FX10#-xP-SV1
10mm	FX10#-xP-SV1		FX10#-xP-SV1
11mm	FX10#-xP-SV2	FX10-xIP-xD(Q)-8PH	FX10#-xP-SV1
12mm	FX10#-xP-SV3		FX10#-xP-SV1
13mm	FX10#-xP-SV4		FX10#-xP-SV1
			FX10#-xP-SV1

◆ Interposer removal

The interposer can be removed from the mounting header by hand. (No special tools are needed.) Removal and re-mating of the fixed side can reduce the extraction force of the fixed side due to wear. It is recommended to replace the interposer to a new one once removed.

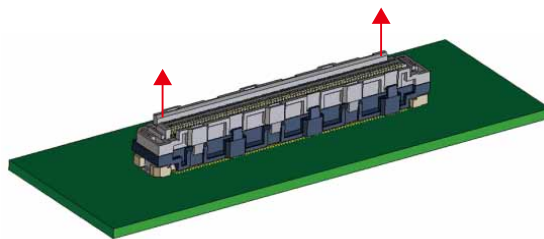

◆ Multiple Mating

<2-piece type>

It is not recommended to use multiple 2-piece FX10 connectors on the same PWB.



<3-piece type>

FX10 3-piece type has multiple mating capability. If multiple connectors are used on the same PWB, they must be oriented in the same direction. It is not recommended to mix orientations.

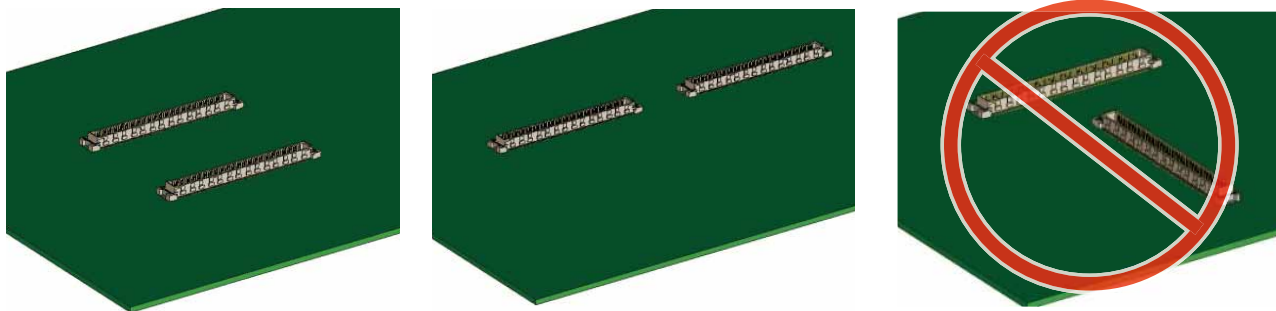

● Mating tolerance (3-piece type)

Due to the floating interposer, FX10 3-piece type can accept mating tolerances of up to $\pm 0.15\text{mm}$ tolerance in the X-axis and up to $\pm 0.15\text{mm}$ in the Y-axis.

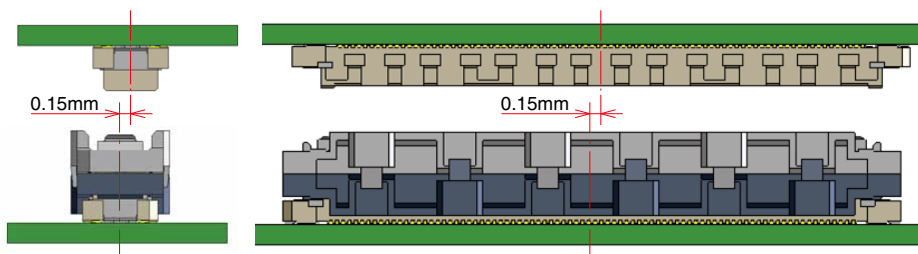

USA:

HIROSE ELECTRIC (U.S.A.), INC. HEADQUARTERS CHICAGO OFFICE
 2300 Warrenville Road, Suite 150,
 Downers Grove, IL 60515
 Phone : +1-630-282-6700
<http://www.hirose.com/us/>

USA:

HIROSE ELECTRIC (U.S.A.), INC. SAN JOSE OFFICE
 2841 Junction Ave, Suite 200
 San Jose, CA. 95134
 Phone : +1-408-253-9640
 Fax : +1-408-253-9641
<http://www.hirose.com/us/>

USA:

HIROSE ELECTRIC (U.S.A.), INC. DETROIT OFFICE (AUTOMOTIVE)
 17197 N. Laurel Park Drive, Suite 253,
 Livonia, MI 48152
 Phone : +1-734-542-9963
 Fax : +1-734-542-9964
<http://www.hirose.com/us/>

THE NETHERLANDS:

HIROSE ELECTRIC EUROPE B.V.
 Hogehillweg #8 1101 CC Amsterdam Z-O
 Phone : +31-20-6557460
 Fax : +31-20-6557469
<http://www.hirose.com/eu/>

GERMANY:

HIROSE ELECTRIC EUROPE B.V. GERMAN BRANCH
 Schoenbergstr. 20, 73760 ostfildern
 Phone : +49-711-456002-1
 Fax : +49-711-456002-299
<http://www.hirose.com/eu/>

GERMANY:

HIROSE ELECTRIC EUROPE B.V. NUREMBERG OFFICE
 Neumeyerstrasse 22-26, 90411 Nurnberg
 Phone : +49-911 32 68 89 63
 Fax : +49-911 32 68 89 69
<http://www.hirose.com/eu/>

GERMANY:

HIROSE ELECTRIC EUROPE B.V. HANOVER OFFICE
 Bayernstr. 3, Haus C 30855 Langenhagen, Germany
 Phone : +49-511 97 82 61 30
 Fax : +49-511 97 82 61 35
<http://www.hirose.com/eu/>

FRANCE:

HIROSE ELECTRIC EUROPE B.V. PARIS OFFICE
 Regus La Garenne Colombes, Place de La Belgique,
 71 Boulevard National La Garenne Colombes, 92250, France
 Phone : +33 (0) 1 7082 3170
 Fax : +33 (1) 7082 3101
<http://www.hirose.com/eu/>

UNITED KINGDOM:

HIROSE ELECTRIC EUROPE BV (UK BRANCH)
 4 Newton Court, Kelvin Drive, Knowlhill,
 Milton Keynes, MK5 8NH
 Phone : +44-1908 202050
 Fax : +44-1908 202058
<http://www.hirose.com/eu/>

CHINA:

HIROSE ELECTRIC (SHANGHAI) CO., LTD.
 1601, Henderson Metropolitan, NO.300, East Nanjing
 Road, Huangpu District, Shanghai, China 200001
 Phone : +86-21-6391-3355
 Fax : +86-21-6391-3335
<http://www.hirose.com/cn/>

CHINA:

HIROSE ELECTRIC (SHANGHAI) CO.,LTD. BEIJING BRANCH
 A1001, Ocean International Center, Building 56# East 4th
 Ring Middle Road, ChaoYang District, Beijing, 100025
 Phone : +86-10-5165-9332
 Fax : +86-10-5908-1381
<http://www.hirose.com/cn/>

CHINA:

HIROSE ELECTRIC TECHNOLOGIES (SHENZHEN) CO., LTD.
 Room 09-13, 19/F, Office Tower Shun Hing Square, Di Wang Commercial Centre,
 5002 Shen Nan Dong Road, Shenzhen City, Guangdong Province, 518008
 Phone : +86-755-8207-0851
 Fax : +86-755-8207-0873
<http://www.hirose.com/cn/>

HONG KONG:

HIROSE ELECTRIC HONGKONG TRADING CO., LTD.
 Room 1001, West Wing, Tsim Sha Tsui Centre, 66
 Mody Road, Tsim Sha Tsui East, Kowloon, Hong Kong
 Phone : +852-2803-5338
 Fax : +852-2591-6560
<http://www.hirose.com/hk/>

TAIWAN:

HIROSE ELECTRIC TAIWAN CO., LTD.
 103 8F, No.87, Zhengzhou Rd., Taipei
 Phone : +886-2-2555-7377
 Fax : +886-2-2555-7350
<http://www.hirose.com/tw/>

KOREA:

HIROSE KOREA CO.,LTD.
 250, Huimanggongwon-ro, Siheung-si,
 Gyeonggi-do, Korea, 15083
 Phone : +82-31-496-7000 or 7124
 Fax : +82-31-496-7100
<http://www.hirose.co.kr/>

SINGAPORE:

HIROSE ELECTRIC SINGAPORE PTE. LTD.
 10 Anson Road #26-16, International Plaza
 079903, Singapore
 Phone : +65-6324-6113
 Fax : +65-6324-6123
<http://www.hirose.com/sg/>

INDIA:

HIROSE ELECTRIC SINGAPORE PTE. LTD. DELHI LIAISON OFFICE
 Office NO.552, Regus-Green Boulevard, Level5, Tower C,
 Sec62, Plot B-9A, Block B, Noida, 201301, Uttar Pradesh, India
 Phone : +91-12-660-8018
 Fax : +91-120-4804949
<http://www.hirose.com/sg/>

INDIA:

HIROSE ELECTRIC SINGAPORE PTE. LTD. BANGALORE LIAISON OFFICE
 Unit No-403, 4th Floor, No-84, Barton Centre, Mahatma
 Gandhi (MG) Road, Bangalore 560 001, Karnataka, India
 Phone : +91-80-4120 1907
 Fax : +91-80-4120 9908
<http://www.hirose.com/sg/>

MALAYSIA:

PENANG REPRESENTATIVE OFFICE
 1-21-01, Suntech @ Penang Cybercity (1164), Lintang
 Mayang Pasir 3,11950, Bayan Baru, Penang, Malaysia.
 Phone : +604-619-2564
 Fax : +604-619-2574
<http://www.hirose.com/sg/>

THAILAND:

BANGKOK OFFICE (REPRESENTATIVE OFFICE)
 Unit 4703, 47th FL., 1 Empire Tower, South Sathorn
 Road, Yannawa, Sathorn, Bangkok 10120 Thailand
 Phone : +66-2-686-1255
 Fax : +66-2-686-3433
<http://www.hirose.com/sg/>



HIROSE ELECTRIC CO.,LTD.

2-6-3,Nakagawa Chuoh,Tsuzuki-Ku,Yokohama-Shi 224-8540,JAPAN
 TEL: +81-45-620-3526 Fax: +81-45-591-3726
<http://www.hirose.com>
<http://www.hirose-connectors.com>