

ESC, Aluminum Electrolytic, 105C LowZ, 470 uF, 20%, 16 VDC, -40/+105C, Lead Spacing = 5mm

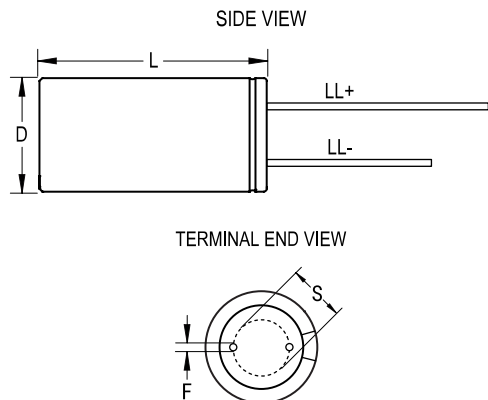

General Information	
Supplier:	KEMET
Series:	ESC
Dielectric:	Aluminum Electrolytic
Description:	LowESR Single Ended Aluminum Electrolytic
Features:	Low ESR
RoHS:	Yes
Lead:	Wire Leads

Dimensions	
D	10mm +/-0.5mm
L	12mm +1.5mm
S	5mm +/-0.5mm
LL Negative	15mm MIN
LL Positive	20mm MIN
F	0.6mm NOM

Specifications	
Capacitance:	470 uF
Capacitance Tolerance:	20%
Voltage DC:	16 VDC, 20 VDC (Surge)
Temperature Range:	-40/+105C
Rated Temperature:	105C
Life:	2000 Hrs
Dissipation Factor:	12.00%
Resistance:	0.085 Ohms (100kHz)
Ripple Current:	800 mAmps (100kHz 105C)
Leakage Current:	75 uA (2min 20C)
Impedance Ratio at -25C:	3
Impedance Ratio at -40C:	4

Packaging Specifications	
Packaging:	Bulk, Bag
Packaging Quantity:	4000