

CAT4237

High Voltage CMOS Boost White LED Driver

Description

The CAT4237 is a DC/DC step-up converter that delivers an accurate constant current ideal for driving LEDs. Operation at a constant switching frequency of 1 MHz allows the device to be used with small value external ceramic capacitors and inductor. LEDs connected in series are driven with a regulated current set by the external resistor R_1 . LED currents up to 40 mA can be supported over a wide range of input supply voltages from 2.8 V to 5.5 V, making the device ideal for battery-powered applications. The CAT4237 high-voltage output stage is perfect for driving six, seven or eight white LEDs in series with inherent current matching in LCD backlight applications.

LED dimming can be done by using a DC voltage, a logic signal, or a pulse width modulation (PWM) signal. The shutdown input pin allows the device to be placed in power-down mode with “zero” quiescent current.

In addition to thermal protection and overload current limiting, the device also enters a very low power operating mode during “Open LED” fault conditions. The device is housed in a low profile (1 mm max height) 5-lead thin SOT23 package for space critical applications.

Features

- Drives 6 to 8 White LEDs in Series from 3 V
- Up to 87% Efficiency
- Low Quiescent Ground Current 0.6 mA
- Adjustable Output Current (up to 40 mA)
- High Frequency 1 MHz Operation
- High Voltage Power Switch
- Shutdown Current Less than 1 μ A
- Open LED Low Power Mode
- Automatic Shutdown at 1.9 V (UVLO)
- Thermal Shutdown Protection
- Thin SOT23 5-lead (1 mm Max Height)
- These Devices are Pb-Free, Halogen Free/BFR Free and are RoHS Compliant

Applications

- Color LCD and Keypad Backlighting
- Cellular Phones
- Handheld Devices
- Digital Cameras
- PDAs
- Portable Game Machine



ON Semiconductor®

<http://onsemi.com>



TSOT-23
TD SUFFIX
CASE 419AE

PIN CONNECTIONS

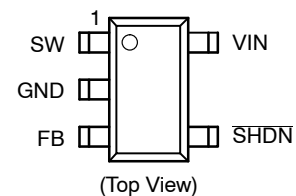

MARKING DIAGRAMS

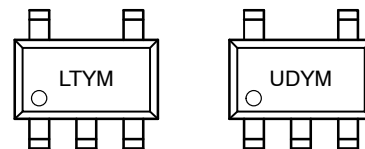

LT = CAT4237TD-T3
UD = CAT4237TD-GT3
Y = Production Year (Last Digit)
M = Production Month (1-9, A, B, C)

ORDERING INFORMATION (Note 3)

Device	Package	Shipping (Note 4)
CAT4237TD-T3 (Note 1)	TSOT-23 (Pb-Free)	3,000/ Tape & Reel
CAT4237TD-GT3 (Note 2)	TSOT-23 (Pb-Free)	3,000/ Tape & Reel

1. Matte-Tin Plated Finish (RoHS-compliant).
2. NiPdAu Plated Finish (RoHS-compliant)
3. For detailed information and a breakdown of device nomenclature and numbering systems, please see the ON Semiconductor Device Nomenclature document, TND310/D, available at www.onsemi.com
4. For information on tape and reel specifications, including part orientation and tape sizes, please refer to our Tape and Reel Packaging Specifications Brochure, BRD8011/D.

CAT4237

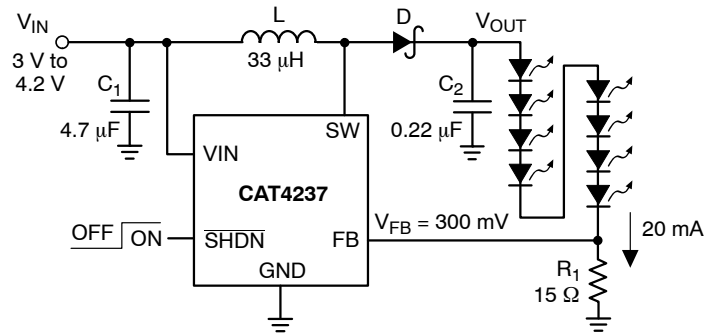

L: Sumida CDRH3D16-330
 D: Central CMDSH05-4 (rated 40 V)
 C2: Taiyo Yuden UMK212BJ224 (rated 50 V)

Figure 1. Typical Application Circuit

Table 1. ABSOLUTE MAXIMUM RATINGS

Parameters	Ratings	Units
V_{IN} , FB voltage	-0.3 to +7	V
SHDN voltage	-0.3 to +7	V
SW voltage	-0.3 to +55	V
Storage Temperature Range	-65 to +160	°C
Junction Temperature Range	-40 to +150	°C
Lead Temperature	300	°C

Stresses exceeding Maximum Ratings may damage the device. Maximum Ratings are stress ratings only. Functional operation above the Recommended Operating Conditions is not implied. Extended exposure to stresses above the Recommended Operating Conditions may affect device reliability.

Table 2. RECOMMENDED OPERATING CONDITIONS

Parameters	Range	Units
V_{IN}	2.8 to 5.5	V
SW pin voltage	0 to 30	V
Ambient Temperature Range	-40 to +85	°C
6, 7 or 8 LEDs	1 to 40	mA

NOTE: Typical application circuit with external components is shown above.

5. Thin SOT23-5 package thermal resistance $\theta_{JA} = 135^{\circ}\text{C}/\text{W}$ when mounted on board over a ground plane.

Table 3. DC ELECTRICAL CHARACTERISTICS

(V_{IN} = 3.6 V, ambient temperature of 25°C (over recommended operating conditions unless otherwise specified))

Symbol	Parameter	Conditions	Min	Typ	Max	Unit
I _Q	Operating Current	V _{FB} = 0.2 V V _{FB} = 0.4 V (not switching)		0.6 0.1	1.5 0.6	mA
I _{SD}	Shutdown Current	V _{SHDN} = 0 V		0.1	1	μA
V _{FB}	FB Pin Voltage	8 LEDs with I _{LED} = 20 mA	285	300	315	mV
I _{FB}	FB pin input leakage				1	μA
I _{LED}	Programmed LED Current	R1 = 10 Ω R1 = 15 Ω R1 = 20 Ω	28.5 19 14.25	30 20 15	31.5 21 15.75	mA
V _{IH} V _{IL}	SHDN Logic High SHDN Logic Low	Enable Threshold Level Shutdown Threshold Level	0.4	0.8 0.7	1.5	V
F _{SW}	Switching Frequency		0.8	1.0	1.3	MHz
I _{LIM}	Switch Current Limit		350	450	600	mA
R _{SW}	Switch "On" Resistance	I _{SW} = 100 mA		1.0	2.0	Ω
I _{LEAK}	Switch Leakage Current	Switch Off, V _{SW} = 5 V		1	5	μA
	Thermal Shutdown			150		°C
	Thermal Hysteresis			20		°C
V _{UVLO}	Undervoltage Lockout (UVLO) Threshold			1.9		V
V _{OV-SW}	Overvoltage Threshold			35		V

Pin Description

VIN is the supply input for the internal logic. The device is compatible with supply voltages down to 2.8 V and up to 5.5 V. It is recommended that a small bypass ceramic capacitor (4.7 μF) be placed between the VIN and GND pins near the device. If the supply voltage drops below 1.9 V, the device stops switching.

SHDN is the shutdown logic input. When the pin is tied to a voltage lower than 0.4 V, the device is in shutdown mode, drawing nearly zero current. When the pin is connected to a voltage higher than 1.5 V, the device is enabled.

GND is the ground reference pin. This pin should be connected directly to the ground plane on the PCB.

SW pin is connected to the drain of the internal CMOS power switch of the boost converter. The inductor and the Schottky diode anode should be connected to the SW pin. Traces going to the SW pin should be as short as possible with minimum loop area. An over-voltage detection circuit is connected to the SW pin. When the voltage reaches 35 V, the device enters a low power operating mode preventing the SW voltage from exceeding the maximum rating.

FB feedback pin is regulated at 0.3 V. A resistor connected between the FB pin and ground sets the LED current according to the formula:

$$I_{LED} = \frac{0.3 V}{R_1}$$

The lower LED cathode is connected to the FB pin.

Table 4. PIN DESCRIPTIONS

Pin #	Name	Function
1	SW	Switch pin. This is the drain of the internal power switch.
2	GND	Ground pin. Connect the pin to the ground plane.
3	FB	Feedback pin. Connect to the last LED cathode.
4	SHDN	Shutdown pin (Logic Low). Set high to enable the driver.
5	VIN	Power Supply input.

Block Diagram

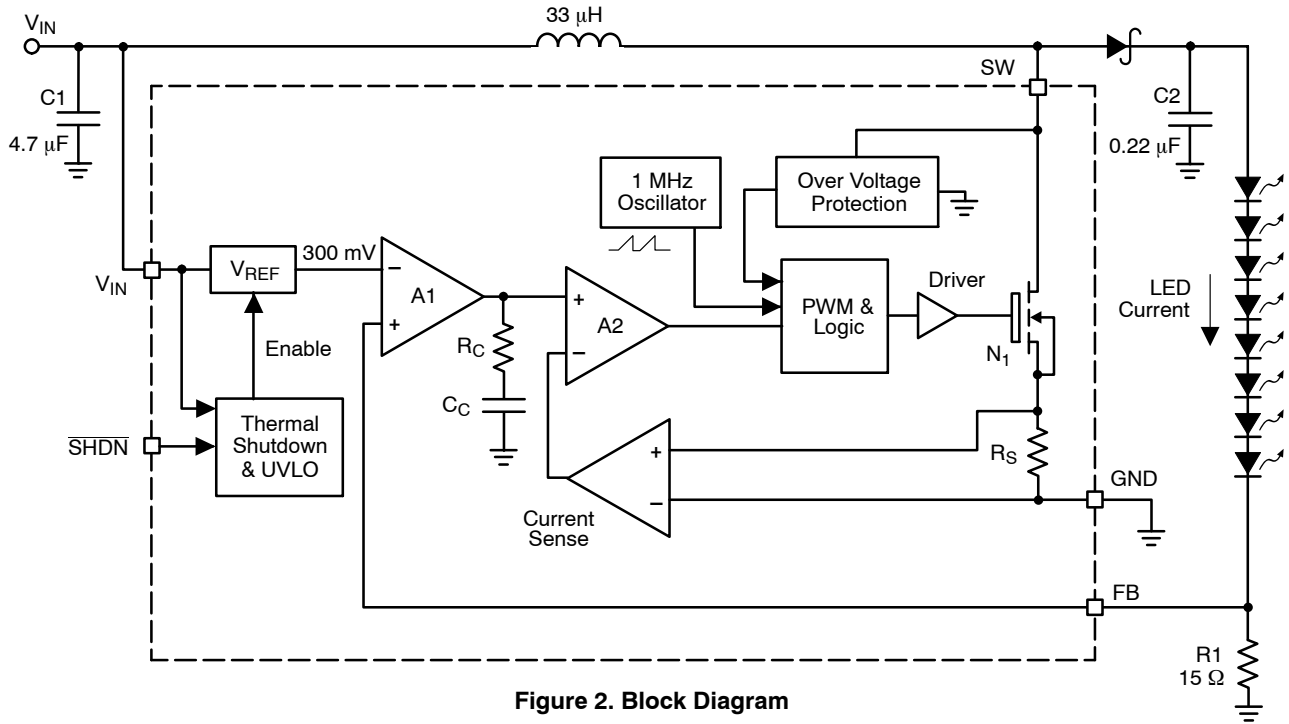

Figure 2. Block Diagram

Device Operation

The CAT4237 is a fixed frequency (1 MHz), low noise, inductive boost converter that provides a constant current with excellent line and load regulation. The device uses a high-voltage CMOS power switch between the SW pin and ground to energize the inductor. When the switch is turned off, the stored energy in the inductor is released into the load via the Schottky diode.

The on/off duty cycle of the power switch is internally adjusted and controlled to maintain a constant regulated voltage of 0.3 V across the feedback resistor connected to the feedback pin (FB). The value of the resistor sets the LED current accordingly ($0.3 \text{ V}/R_1$).

During the initial power-up stage, the duty cycle of the internal power switch is limited to prevent excessive in-rush currents and thereby provide a “soft-start” mode of operation.

While in normal operation, the device can deliver up to 40 mA of load current into a string of up to 8 white LEDs.

In the event of an “Open LED” fault condition, where the feedback control loop becomes open, the output voltage will continue to increase. Once this voltage exceeds 35 V, an internal protection circuit will become active and place the device into a very low power safe operating mode where only a small amount of power is transferred to the output. This is achieved by pulsing the switch once every 60 μs and keep it on for about 1 μs only.

Thermal overload protection circuitry has been included to prevent the device from operating at unsafe junction temperatures above 150°C. In the event of a thermal overload condition the device will automatically shutdown and wait till the junction temperatures cools to 130°C before normal operation is resumed.

Light Load Operation

Under light load condition (under 4 mA) and with input voltage above 4.2 V, the CAT4237 driving 6 LEDs, the driver starts pulse skipping. Although the LED current remains well regulated, some lower frequency ripple may appear.

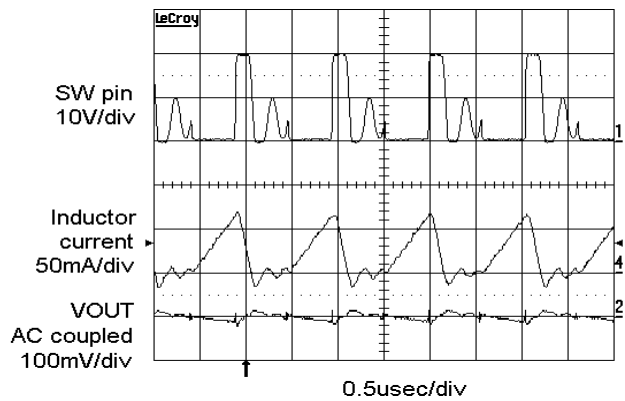

Figure 3. Switching Waveform $V_{IN} = 4.2 \text{ V}$, $I_{LED} = 4 \text{ mA}$

CAT4237

TYPICAL CHARACTERISTICS

($V_{IN} = 3.6\text{ V}$, $C_{IN} = 4.7\ \mu\text{F}$, $C_{OUT} = 0.22\ \mu\text{F}$, $L = 33\ \mu\text{H}$ with 8 LEDs at 20 mA, $T_{AMB} = 25^\circ\text{C}$, unless otherwise specified.)

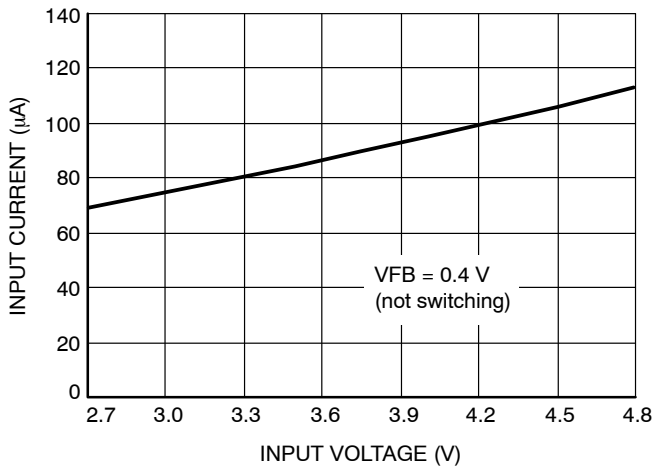

Figure 4. Quiescent Current vs. V_{IN} (Not Switching)

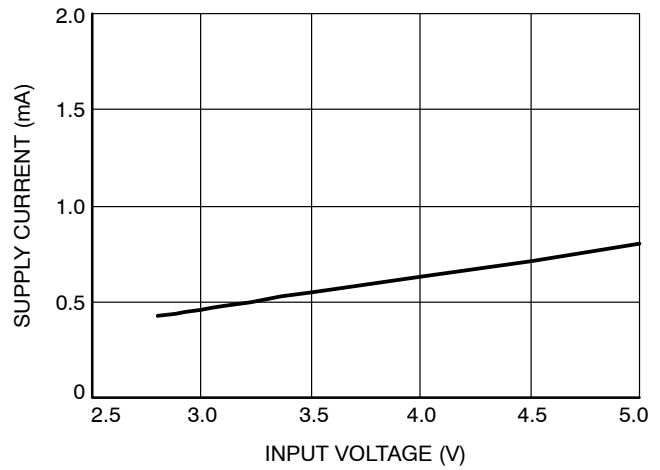

Figure 5. Quiescent Current vs. V_{IN} (Switching)

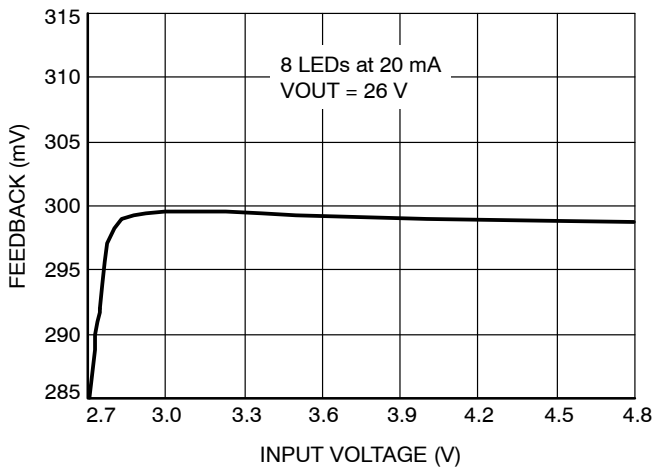

Figure 6. FB Pin Voltage vs. Supply Voltage

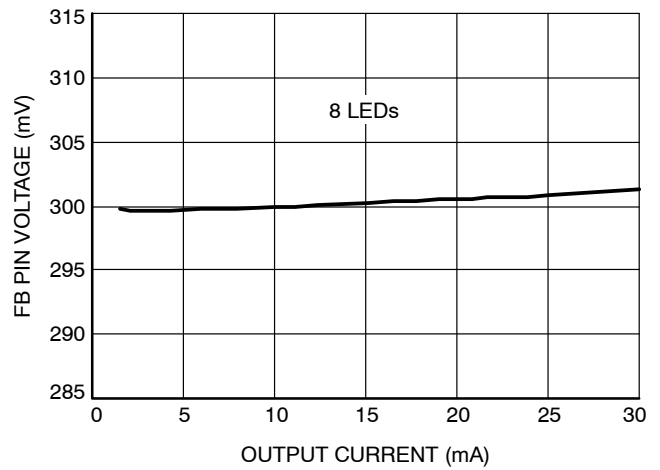

Figure 7. FB Pin Voltage vs. Output Current

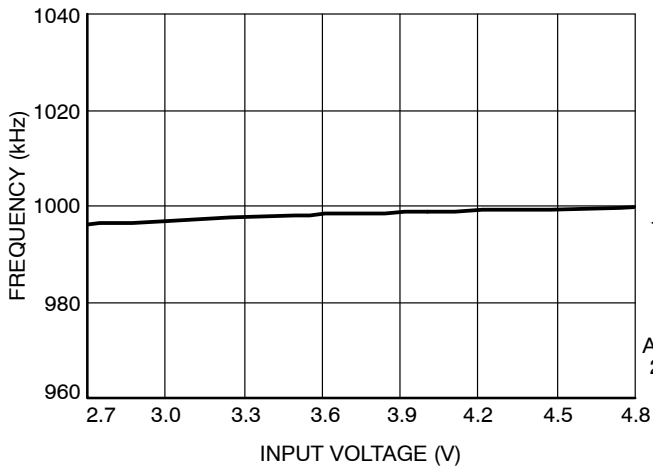

Figure 8. Switching Frequency vs. Supply Voltage

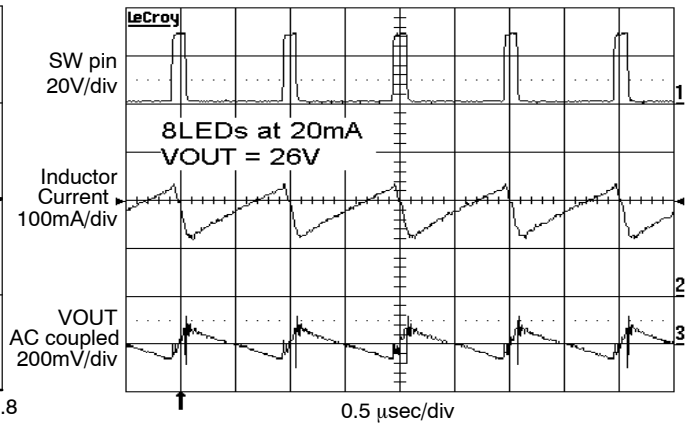

Figure 9. Switching Waveforms

TYPICAL CHARACTERISTICS

($V_{IN} = 3.6\text{ V}$, $C_{IN} = 4.7\ \mu\text{F}$, $C_{OUT} = 0.22\ \mu\text{F}$, $L = 33\ \mu\text{H}$ with 8 LEDs at 20 mA, $T_{AMB} = 25^\circ\text{C}$, unless otherwise specified.)

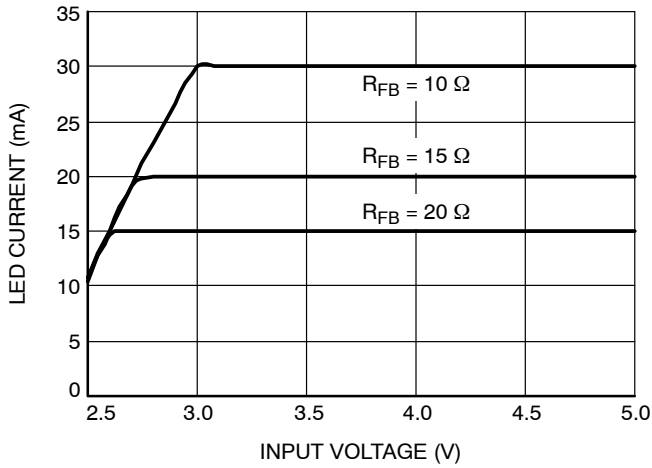

Figure 10. LED Current vs. Input Voltage (8 LEDs)

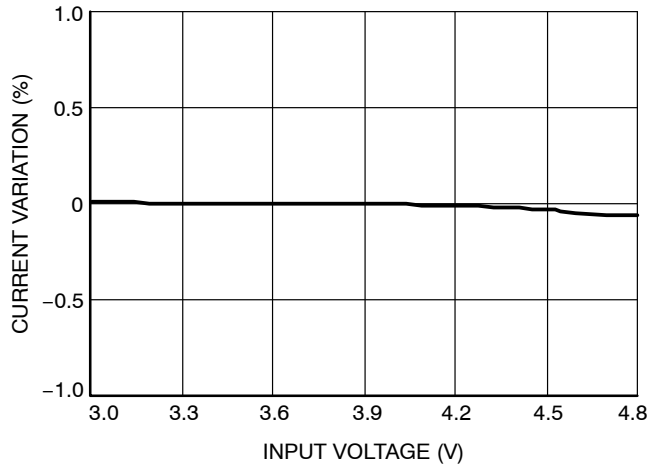

Figure 11. LED Current Regulation (20 mA)

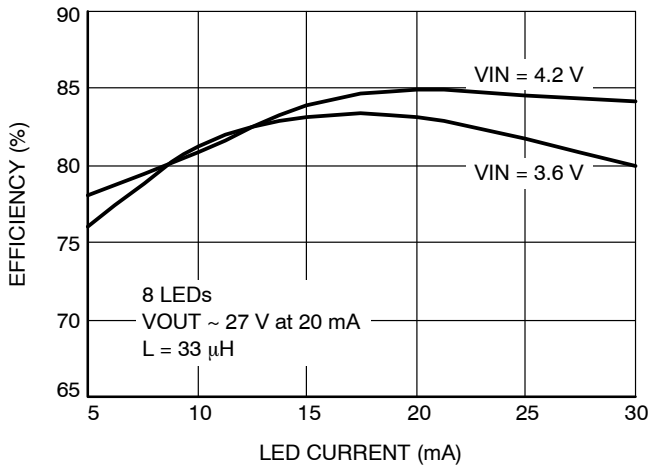

Figure 12. 8 LED Efficiency vs. Load Current

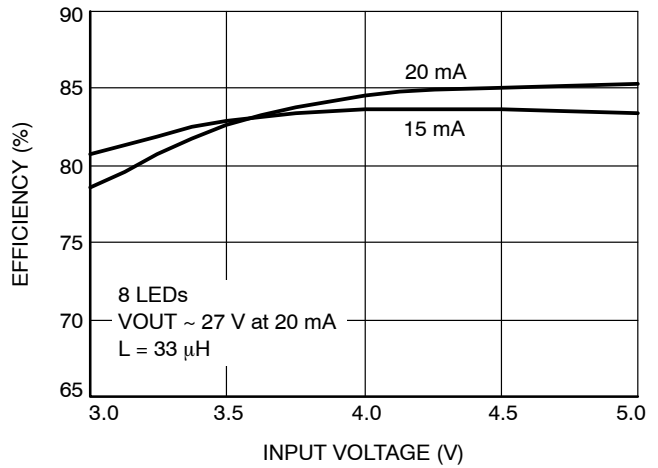

Figure 13. 8 LED Efficiency vs. Input Voltage

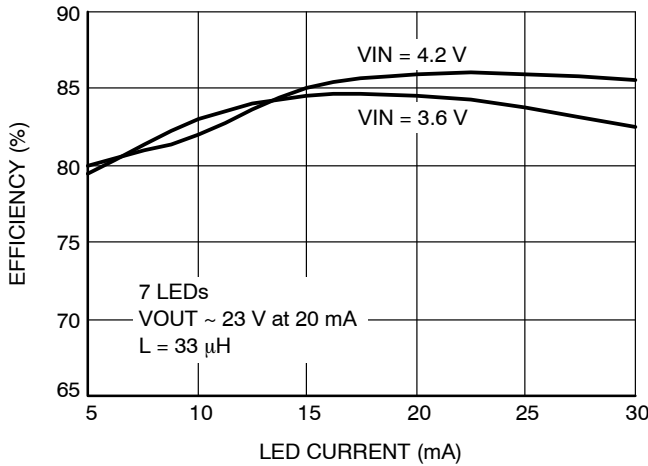

Figure 14. 7 LED Efficiency vs. Load Current

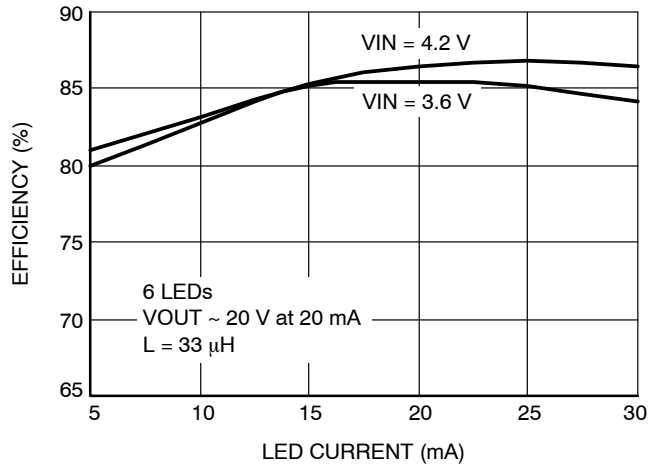

Figure 15. 6 LED Efficiency vs. Load Current

TYPICAL CHARACTERISTICS

($V_{IN} = 3.6\text{ V}$, $C_{IN} = 4.7\ \mu\text{F}$, $C_{OUT} = 0.22\ \mu\text{F}$, $L = 33\ \mu\text{H}$ with 8 LEDs at 20 mA, $T_{AMB} = 25^\circ\text{C}$, unless otherwise specified.)

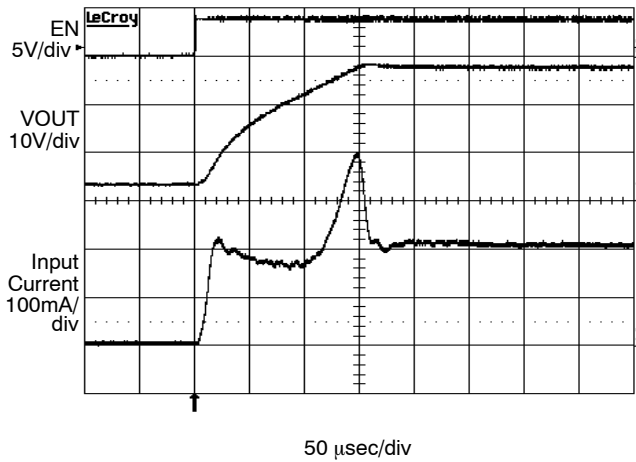

Figure 16. Power-up with 8 LEDs at 20 mA

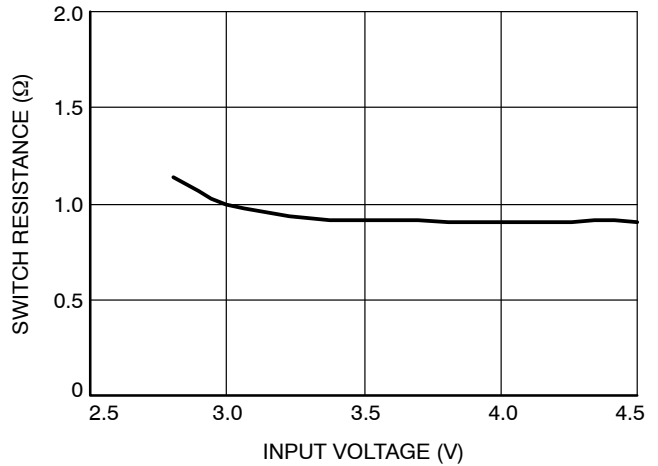

Figure 17. Switch ON Resistance vs. Input Voltage

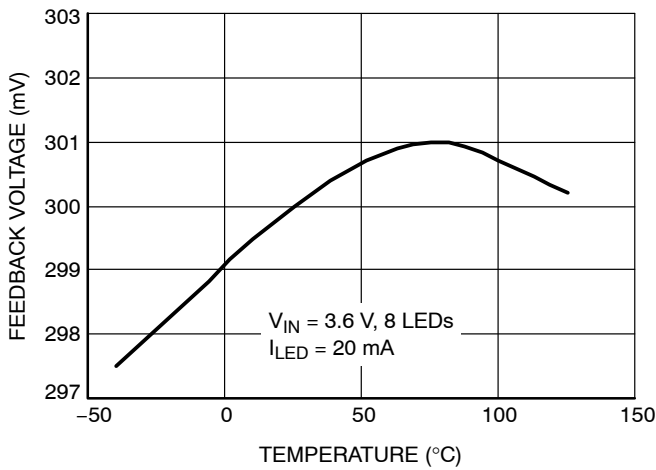

Figure 18. FB Pin Voltage vs. Temperature

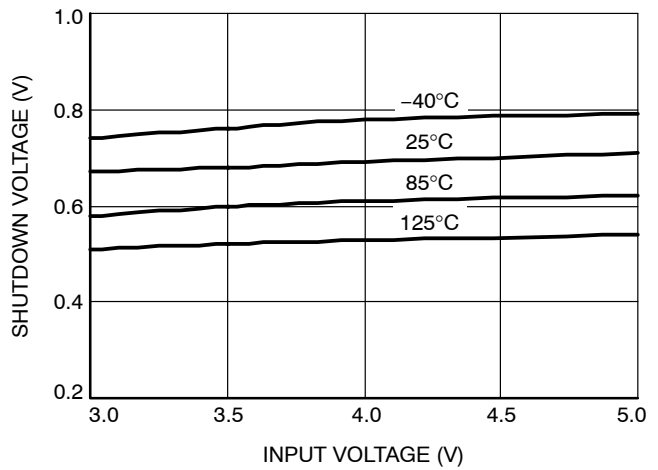

Figure 19. Shutdown Voltage vs. Input Voltage

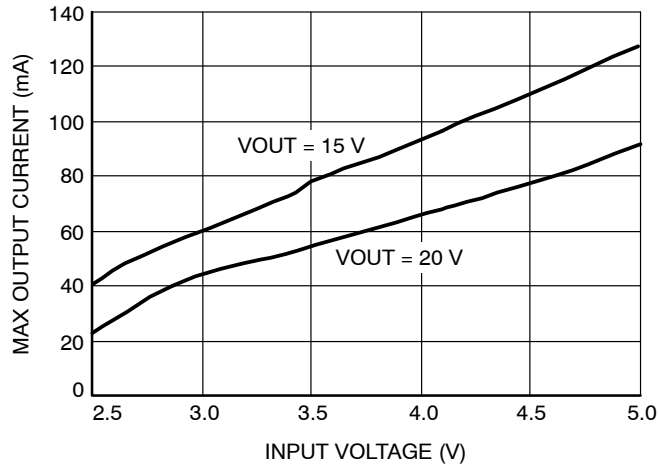

Figure 20. Maximum Output Current vs. Input Voltage

Application Information

External Component Selection

Capacitors

The CAT4237 only requires small ceramic capacitors of 4.7 µF on the input and 0.22 µF on the output. Under normal condition, a 4.7 µF input capacitor is sufficient. For applications with higher output power, a larger input capacitor of 10 µF may be appropriate. X5R and X7R capacitor types are ideal due to their stability across temperature range.

Inductor

A 33 µH inductor is recommended for most of the CAT4237 applications. In cases where the efficiency is critical, inductances with lower series resistance are preferred. Inductors with current rating of 300 mA or higher are recommended for most applications. Sumida CDRH3D16-330 33 µH inductor has a rated current of 320 mA and a series resistance (D.C.R.) of 520 mΩ typical.

Schottky Diode

The current rating of the Schottky diode must exceed the peak current flowing through it. The Schottky diode performance is rated in terms of its forward voltage at a

given current. In order to achieve the best efficiency, this forward voltage should be as low as possible. The response time is also critical since the driver is operating at 1 MHz. Central Semiconductor Schottky diode CMDSH05-4 (500 mA rated) is recommended for most applications.

LED Current Setting

The LED current is set by the external resistor R₁ connected between the feedback pin (FB) and ground. The formula below gives the relationship between the resistor and the current:

$$R_1 = \frac{0.3 \text{ V}}{\text{LED current}}$$

Table 5. RESISTOR R₁ AND LED CURRENT

LED Current (mA)	R ₁ (Ω)
5	60
10	30
15	20
20	15
25	12
30	10

Open LED Protection

In the event of an “Open LED” fault condition, the CAT4237 will continue to boost the output voltage with maximum power until the output voltage reaches approximately 35 V. Once the output exceeds this level, the internal circuitry immediately places the device into a very low power mode where the total input power is limited to about 4 mW (about 1 mA input current with a 3.6 V supply). The SW pin clamps at a voltage below its maximum rating of 60 V. There is no need to use an external zener diode between Vout and the FB pin. A 50 V rated C₂ capacitor is required to prevent any overvoltage damage in the open LED condition.

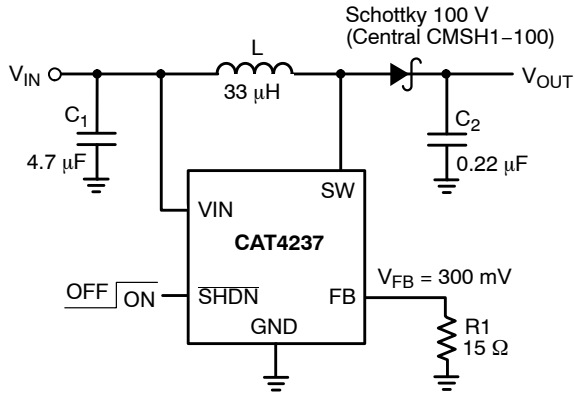

Figure 21. Open LED Protection without Zener

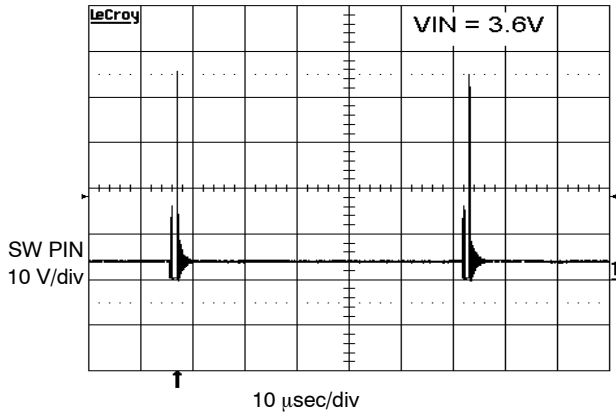

Figure 22. Open LED Switching Waveforms without Zener

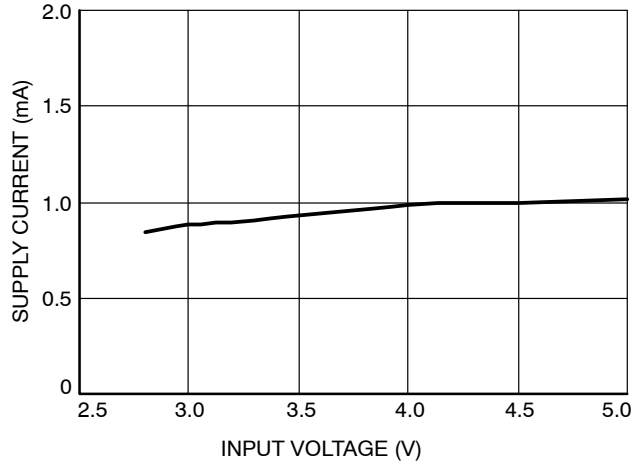

Figure 23. Open LED Supply Current vs. V_{IN} without Zener

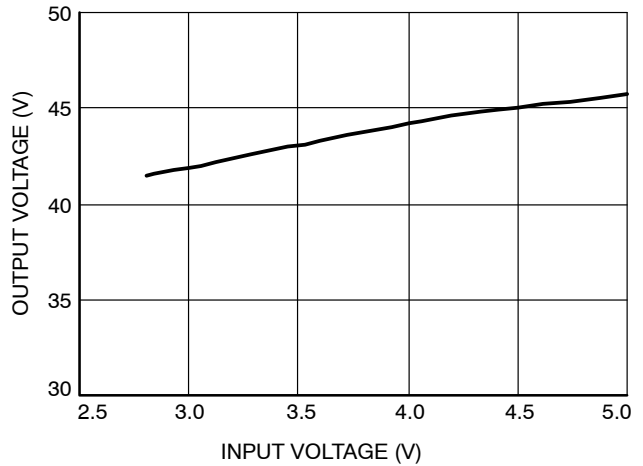

Figure 24. Open LED Output Voltage vs. V_{IN} without Zener

Dimming Control

There are several methods available to control the LED brightness.

PWM Signal on the SHDN Pin

LED brightness dimming can be done by applying a PWM signal to the SHDN input. The LED current is repetitively turned on and off, so that the average current is proportional to the duty cycle. A 100% duty cycle, with SHDN always high, corresponds to the LEDs at nominal current. Figure 25 shows a 1 kHz signal with a 50% duty cycle applied to the SHDN pin. The recommended PWM frequency range is from 100 Hz to 2 kHz.

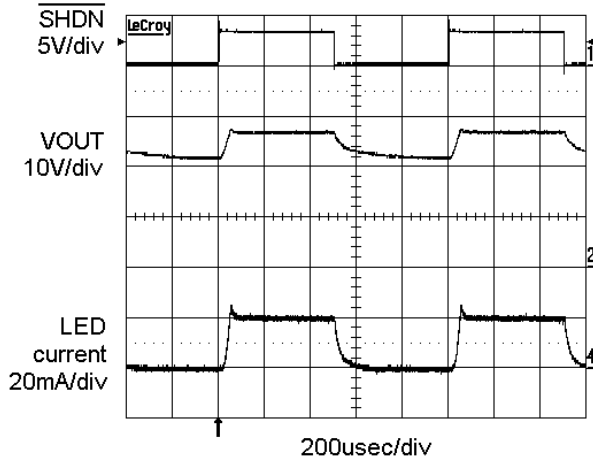

Figure 25. Switching Waveform with 1 kHz PWM on SHDN

Filtered PWM Signal

A filtered PWM signal used as a variable DC voltage can control the LED current. Figure 26 shows the PWM control circuitry connected to the CAT4237 FB pin. The PWM signal has a voltage swing of 0 V to 2.5 V. The LED current can be dimmed within a range from 0 mA to 20 mA. The PWM signal frequency can vary from very low frequency up to 100 kHz.

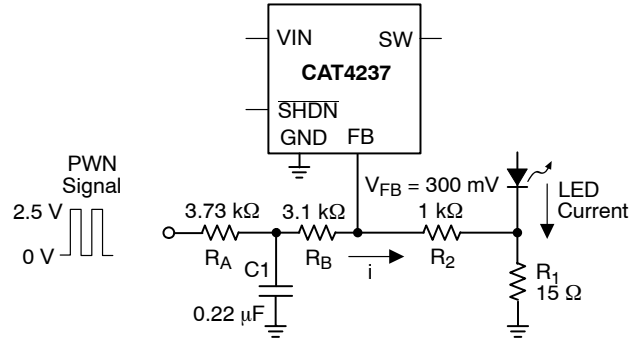

Figure 26. Circuit for Filtered PWM Signal

A PWM signal at 0 V DC, or a 0% duty cycle, results in a max LED current of about 22 mA. A PWM signal with a 93% duty cycle or more, results in an LED current of 0 mA.

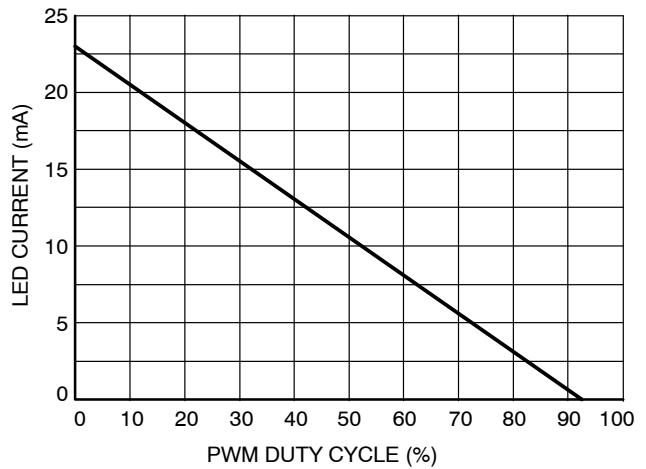

Figure 27. Filtered PWM Dimming (0 V to 2.5 V)

CAT4237

Board Layout

The CAT4237 is a high-frequency switching regulator. The traces that carry the high-frequency switching current have to be carefully layout on the board in order to minimize EMI, ripple and noise in general. The thicker lines on Figure 28 show the switching current path. All these traces have to be short and wide enough to minimize the parasitic inductance and resistance. The loop shown on Figure 28 corresponds to the current path when the CAT4237 internal switch is closed. On Figure 29 is shown the current loop,

when the CAT4237 switch is open. Both loop areas should be as small as possible.

Capacitor C_1 has to be placed as close as possible to the V_{IN} pin and GND. The capacitor C_2 has to be connected separately to the top LED anode. A ground plane under the CAT4237 allows for direct connection of the capacitors to ground. The resistor R_1 must be connected directly to the GND pin of the CAT4237 and not shared with the switching current loops and any other components.

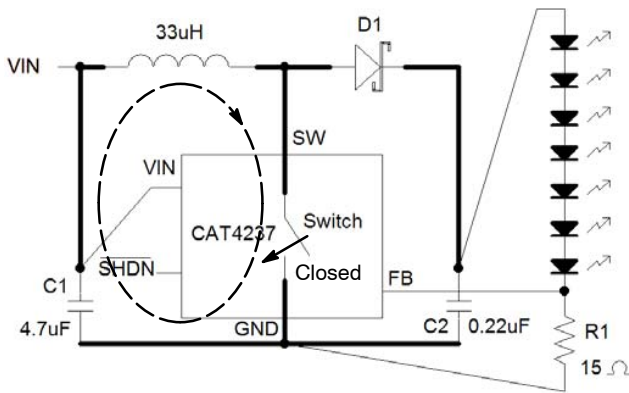

Figure 28. Closed-switch Current Loop

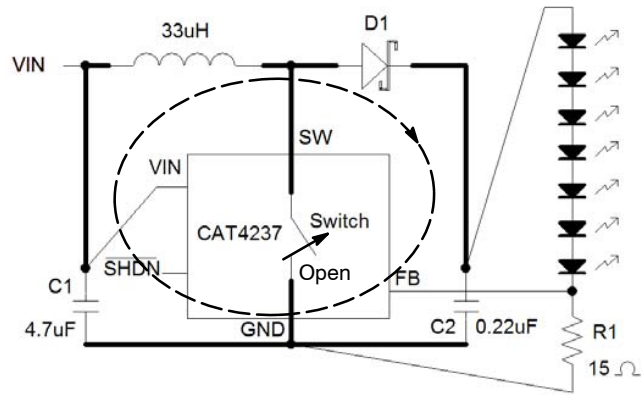
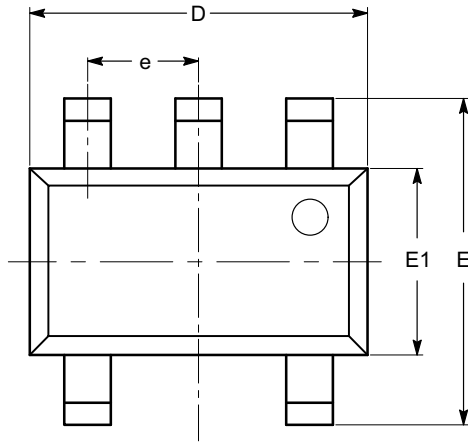

Figure 29. Open-switch Current Loop

CAT4237

PACKAGE DIMENSIONS

TSOT-23, 5 LEAD
CASE 419AE-01
ISSUE O



TOP VIEW

SYMBOL	MIN	NOM	MAX
A			1.00
A1	0.01	0.05	0.10
A2	0.80	0.87	0.90
b	0.30		0.45
c	0.12	0.15	0.20
D	2.90 BSC		
E	2.80 BSC		
E1	1.60 BSC		
e	0.95 TYP		
L	0.30	0.40	0.50
L1	0.60 REF		
L2	0.25 BSC		
θ	0°		8°

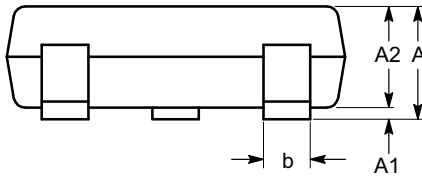

SIDE VIEW

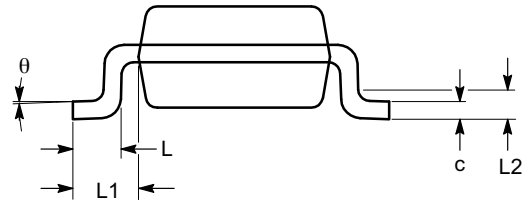

END VIEW

Notes:

- (1) All dimensions are in millimeters. Angles in degrees.
- (2) Complies with JEDEC MO-193.

ON Semiconductor and  are registered trademarks of Semiconductor Components Industries, LLC (SCILLC). SCILLC reserves the right to make changes without further notice to any products herein. SCILLC makes no warranty, representation or guarantee regarding the suitability of its products for any particular purpose, nor does SCILLC assume any liability arising out of the application or use of any product or circuit, and specifically disclaims any and all liability, including without limitation special, consequential or incidental damages. "Typical" parameters which may be provided in SCILLC data sheets and/or specifications can and do vary in different applications and actual performance may vary over time. All operating parameters, including "Typicals" must be validated for each customer application by customer's technical experts. SCILLC does not convey any license under its patent rights nor the rights of others. SCILLC products are not designed, intended, or authorized for use as components in systems intended for surgical implant into the body, or other applications intended to support or sustain life, or for any other application in which the failure of the SCILLC product could create a situation where personal injury or death may occur. Should Buyer purchase or use SCILLC products for any such unintended or unauthorized application, Buyer shall indemnify and hold SCILLC and its officers, employees, subsidiaries, affiliates, and distributors harmless against all claims, costs, damages, and expenses, and reasonable attorney fees arising out of, directly or indirectly, any claim of personal injury or death associated with such unintended or unauthorized use, even if such claim alleges that SCILLC was negligent regarding the design or manufacture of the part. SCILLC is an Equal Opportunity/Affirmative Action Employer. This literature is subject to all applicable copyright laws and is not for resale in any manner.

PUBLICATION ORDERING INFORMATION

LITERATURE FULFILLMENT:

Literature Distribution Center for ON Semiconductor
P.O. Box 5163, Denver, Colorado 80217 USA
Phone: 303-675-2175 or 800-344-3860 Toll Free USA/Canada
Fax: 303-675-2176 or 800-344-3867 Toll Free USA/Canada
Email: orderlit@onsemi.com

N. American Technical Support: 800-282-9855 Toll Free
USA/Canada
Europe, Middle East and Africa Technical Support:
Phone: 421 33 790 2910
Japan Customer Focus Center
Phone: 81-3-5817-1050

ON Semiconductor Website: www.onsemi.com

Order Literature: <http://www.onsemi.com/orderlit>

For additional information, please contact your local Sales Representative