

Recommended Land Pattern

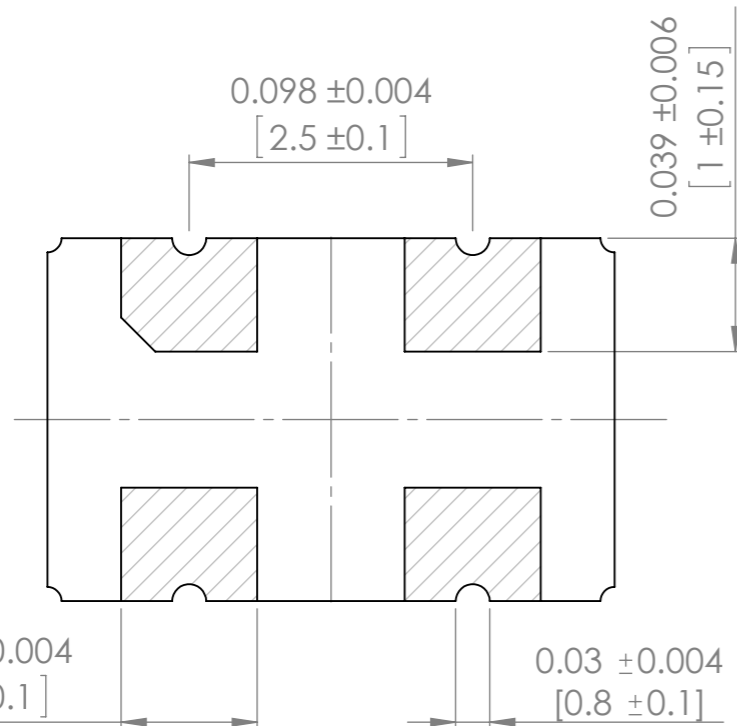

Bottom view

TOP PACKAGE MARKING IS FOR ILLUSTRATION PURPOSES ONLY

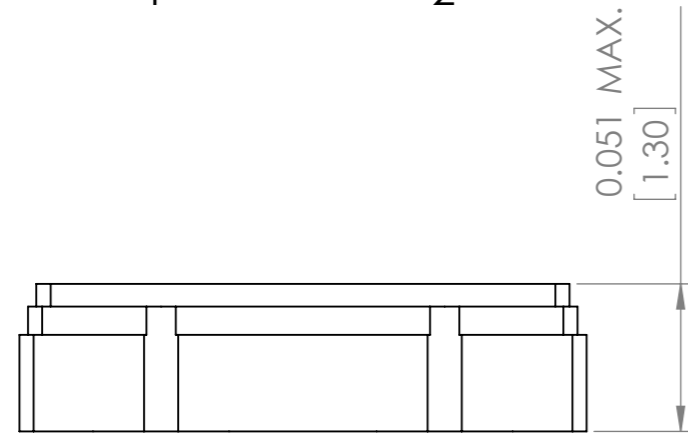
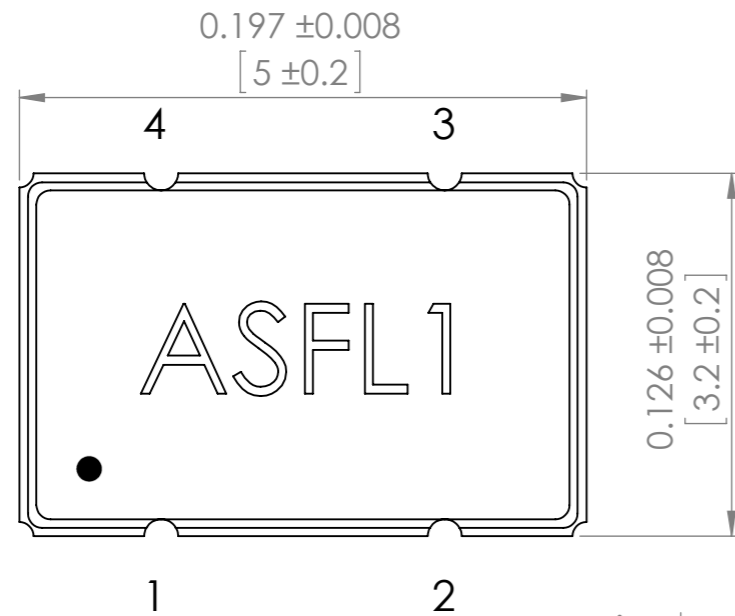
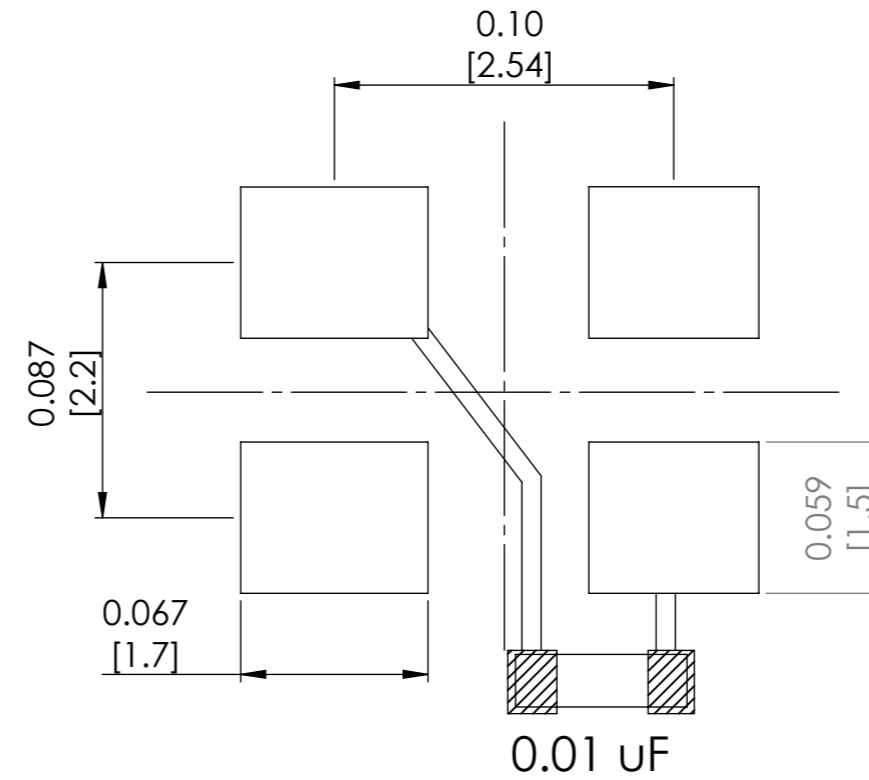

PIN	FUNCTION
1	Tri-state
2	GND
3	Output
4	VDD

Note: : It is recommended to use an approximately 0.01 uF bypass capacitor between PIN 2 and 4.

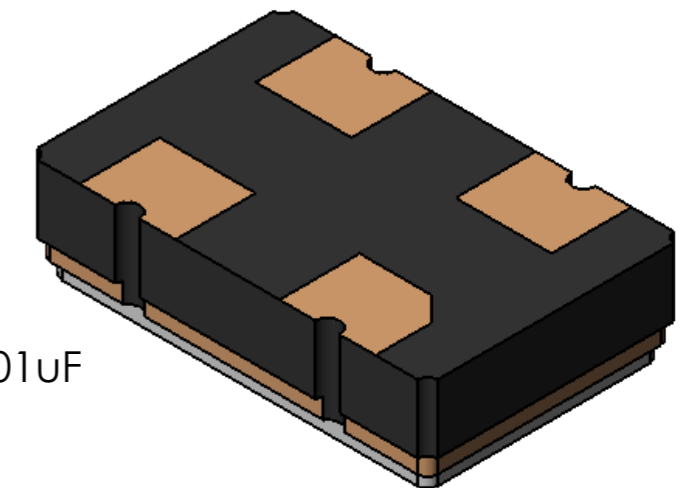
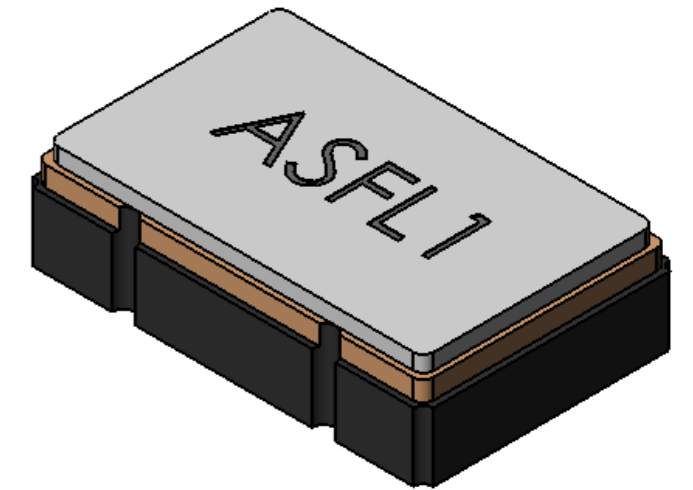

UNLESS OTHERWISE SPECIFIED: DIMENSIONS ARE IN INCH(MM) SURFACE FINISH: TOLERANCES: LINEAR: ANGULAR:		FINISH:	DEBUR AND BREAK SHARP EDGES	DO NOT SCALE DRAWING	REVISION
NAME	SIGNATURE	DATE		 30332 Esperanza, Rancho Santa margarita, California 92688 TITLE: OSCILLATOR DWG NO. ASFL1 SCALE:15:1 SHEET 1 OF 1	
DRAWN	SAAZVAT				
CHK'D	XXXXXX				
APPV'D					
MFG					
Q.A			MATERIAL:		A3
			WEIGHT:		