

© 2007 MaxStream, Inc. All rights reserved

No part of the contents of this manual may be transmitted or reproduced in any form or by any means without the written permission of MaxStream, Inc.

XCite™ is a trademark of MaxStream, Inc.

Technical Support:

Phone: (801) 765-9885

Live Chat: www.maxstream.net

E-mail: rf-xperts@maxstream.net

Contents

1. 9XCite OEM RF Module	4	Appendix A: Agency Certifications	32
1.1. Key Features	4	FCC (United States) Certification	32
1.1.1. Worldwide Acceptance	4	Labeling Requirements	32
1.2. Specifications	5	FCC Notices	32
1.3. Mechanical Drawings	5	Limited Modular Approval	33
1.4. Block Diagram	6	FCC-approved Antennas	33
1.5. Pin Signals	6	IC (Industry Canada) Certification	34
1.6. Electrical Characteristics	7	Labeling Requirements	34
1.6.1. Timing Specifications	7	Appendix B: Additional Information	35
2. RF Module Operation	8	1-Year Warranty	35
2.1. Serial Communications	8	Ordering Information	35
2.1.1. UART-Interfaced Data Flow	8	Contact MaxStream	36
2.1.2. RS-232 and RS-485/422 Data Flow	8		
2.1.3. Serial Data	9		
2.2. Modes of Operation	10		
2.2.1. Idle Mode	10		
2.2.2. Transmit Mode	10		
2.2.3. Receive Mode	11		
2.2.4. Sleep Modes	12		
2.2.5. Command Mode	14		
3. RF Module Configuration	15		
3.1. Command and Parameter Types	15		
3.1.1. AT Commands	15		
3.1.2. Non-AT Settable Parameters (X-CTU Software configurable only)	15		
3.2. Configuration Software	16		
3.2.1. Installation	16		
3.2.2. Serial Communications Software	16		
3.3. Command Reference Tables	17		
3.4. Automatic DIP Switch Configurations	19		
3.5. Command Descriptions	20		
4. Advanced Networking	29		
4.1. Addressing	29		
4.1.1. Vendor Identification Number (ATID)	29		
4.1.2. Channel (ATHP)	30		
4.1.3. Destination Address (ATDT) and Address Mask (ATMK)	30		

1. 9XCite OEM RF Module

The XCite OEM RF Module provides OEMs and system integrators with a low power wireless solution that is easy-to-use.

No configuration is necessary for out-of-box RF operation. Simply feed data into one module; then the data is sent out the other end of the wireless link. If more advanced functionality is needed, the module support an extensive set of commands.

The RF module operates within the ISM 900 MHz frequency band.



1.1. Key Features

Long Range Data Integrity

4 mW Power Output (0 dBm)

- Indoor/Urban: up to 300' (90 m)
- Outdoor RF line-of-sight: up to 1000' (300 m) w/ 2.1 dB dipole antenna

Receiver Sensitivity

- -108 dBm (@ 9600 baud),
- -104 dBm (@ 38400 baud)

Advanced Networking & Security

True Peer-to-Peer (no "master" required), Point-to-Point & Point-to-Multipoint networking
 Hopping (Frequency Hopping Spread Spectrum) or Single Frequency Modes
 7 hopping channels: each with over 65,000 network addresses available
 Up to 9 non-overlapping simultaneous networks

Low Power

Power-down current as low as 20 μ A
 55 mA transmit / 45 mA receive current consumption

Easy-to-Use

No configuration required
 Advanced configurations available through A commands
 2.85 to 5.50 VDC power supply
 Continuous RF data stream of up to 38.4 kbps
 XII™ Interference Immunity
 X-CTU Software included
 Cover more ground with fewer radio modems due to market-leading range

Free & Unlimited Technical Support

1.1.1. Worldwide Acceptance

FCC Certified (USA) [Refer to Appendix A for FCC Requirements]
 Systems that contain XCite Modems inherit MaxStream's FCC Certification

IC (Industry Canada) Certified

ISM (Industrial, Scientific & Medical) license-free 902-928 MHz frequency band

Manufactured under **ISO 9001:2000 registered standards**



1.2. Specifications

Table 1-01. 9XCite OEM RF Module

9XCite 900 MHz OEM RF Module Specifications		
Performance		
Transmit Power Output	4mW	
Indoor/Urban Range	Up to 300' (90 m)	
Outdoor RF line-of-sight Range	Up to 1000' (300 m)	
Interface Data Rate (software selectable using BD command)	1200 –57600 bps	
Throughput Data Rate (baud)	9600 bps	38400 bps
RF Data Rate (baud)	10,000 bps	41,666 bps
Receiver Sensitivity	-108 dBm	-104 dBm
Power Requirements		
Supply Voltage	2.85 to 5.50 VDC	
Transmit Current (@ 2.85V)	55 mA	
Receive Current (@ 2.85V)	45 mA	
Receive Current (@ 5V)	55 mA	
Power-down Current	20 µA	
Networking & Security		
Frequency	902-928 MHz	
Spread Spectrum	Frequency Hopping, Wide band FM modulator	
Modulation	FSK (Frequency Shift Keying)	
Network Topologies Supported	Peer-to-Peer ("Master/Slave" relationship not required), Point-to-Point & Point-to-Multipoint	
Channel Capacity	Hopping Mode - 7 hop sequences share 25 frequencies Single Frequency Mode - 25 available frequencies	
Physical Properties		
RF Module Board Size	1.6" x 2.825" x 0.35" (4.06 cm x 7.17 cm x 0.89 cm)	
Weight	0.8 oz. (24 g)	
Connector	11-Pin & 4-Pin 0.1" spaced Male Berg-type headers	
Operating Temperature	Commercial (0 to 70° C) or Industrial (-40 to 85° C)	
Antenna		
Connector (optional)	RPSMA (Reverse-polarity SMA)	
Type	¼ Wave Monopole, 3" (7.62 cm) integrated wire, 1.9 dBi	
Impedance	50 ohms unbalanced	
Certifications (partial list)		
FCC Part 15.247	OUR-9XCITE	
Industry Canada (IC)	4214A-9XCITE	

1.3. Mechanical Drawings

Figure 1-01. Mechanical Drawings (measured in inches)

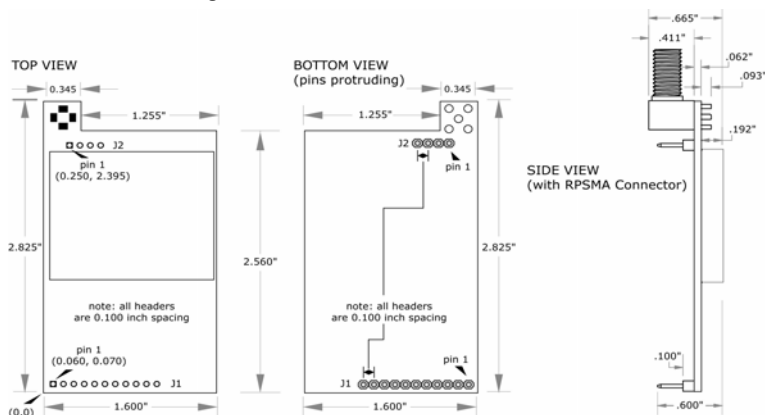

1.4. Block Diagram

Figure 1-02. XCite OEM RF Module Block Diagram

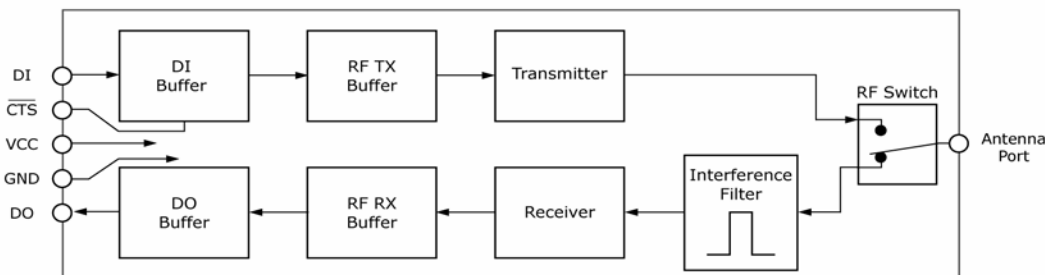

MaxStream's proprietary XII™ (Interference Immunity Technology) is contained in the 'Interference Filter' of the block diagram. The filter blocks interference from pagers and cellular.

1.5. Pin Signals

XCite Module pin signals and their functions:

Table 1-02. J1 Pin Descriptions

(Low-asserted signals distinguished with a horizontal line over signal name.)

Module Pin	Signal Name	I/O	When Active	Description
1	DO2	O*	low	Clear-to-Send (CTS) Flow Control
2	DI3	I*	high	Can be used to enter Sleep Modes that consume less power
3	DO (Data Out)	O*	n/a	Serial Data leaving the XCite Module (to the host)
4	DI (Data In)	I	n/a	Serial data entering the XCite Module (from the host)
5	DI2	I**	low	Request-to-Send (RTS)
6	RESET	I*	low	Reset Module Parameters
7	DO3	O	high	Receive (RX) LED
8	$\overline{\text{TX}}$ / PWR	O	low	$\overline{\text{TX}}$ - Asserted during transmission
			high	PWR - Indicates power is on
9	CONFIG	I***	low	Backup method for entering AT Command Mode. Primary method is with "+++" (refer to the CC parameter)
10	VCC	I	-	2.85 – 5.50 VDC Regulated
11	GND	-	-	Ground

* Pin utilizes 10K Ω Pull-Up resistor (already installed in the module)

** Pin utilizes 10K Ω Pull-Down resistor (already installed in the module)

*** Pin utilizes 100K Ω Pull-Up resistor (already installed in the module)

Note: When integrating the XCite Module onto a Host PC Board, all lines that are not used should be left disconnected (floating).

Table 1-03. J2 Pin Descriptions

J2 pins are used primarily for mechanical stability and may be left disconnected.

Module Pin	Signal Name
1	reserved
2	GND
3	GND
4	GND

1.6. Electrical Characteristics

1.6.1. Timing Specifications

The diagram below shows 9XCite Modules providing an RF Link between hosts.

Figure 1-03. System Block Diagram - RF Link between hosts

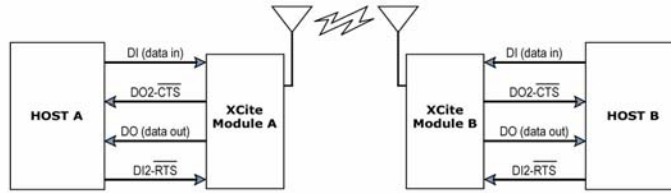

The RF data flow sequence is initiated when the first byte of data is received by the transmitting XCite Module. As long as XCite Module A is not already receiving RF data, the serial data goes into the DI Buffer, is packetized, and then transmitted to XCite Module B.

Figure 1-04. Timing Specifications ("A" and "B" are associated with Figure 6)

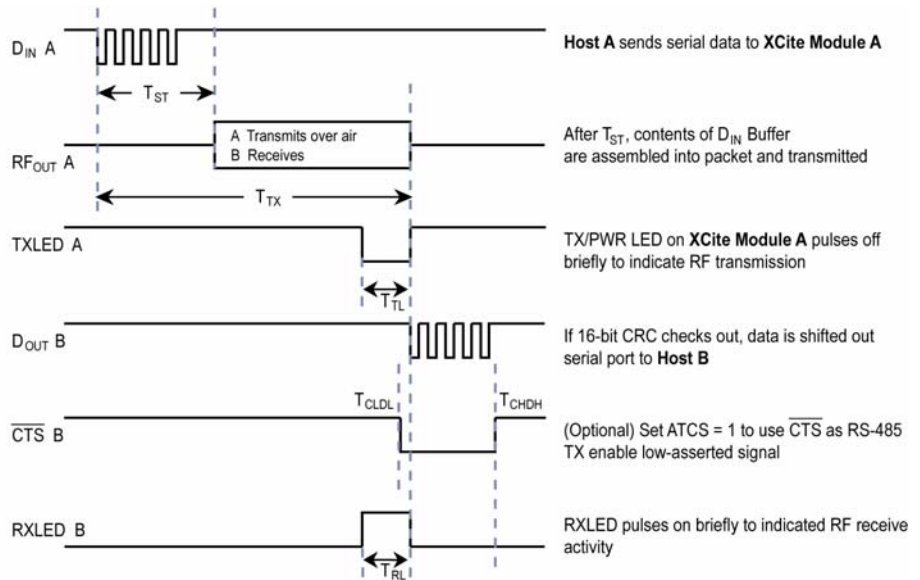

Table 1-04. DC Characteristics (Vcc = 2.85 to 5.50V)

Symbol	Parameter	Condition	Min	Typical	Max	Units
V _{IL}	Input Low Voltage	All input signals	-0.5		0.3 * Vcc	V
V _{IH}	Input High Voltage	All except RESET pin	0.6 * Vcc		Vcc + 0.5	V
V _{IH2}	Input High Voltage	RESET pin *	0.9 * Vcc		Vcc + 0.5	V
V _{OL}	Output Low Voltage	I _{OL} = 20 mA, Vcc = 5V			0.7 0.5	V
V _{OH}	Output High Voltage	I _{OH} = -20 mA, Vcc = 5V	4.0 2.0			V
I _{IL}	Input Leakage Current I/O Pin	Vcc = 5.5V, pin low (absolute value)			3	µA
I _{IH}	Input Leakage Current I/O Pin	Vcc = 5.5V, pin high (absolute value)			3	µA
I _{IL2}		CTS, DO, RESET		(Vcc - VI) / 10 **		mA
I _{IL3}		CONFIG		(Vcc - VI) / 47 **		mA
I _{IH2}		RTS		(Vcc - VI) / 10 **		mA

* Reset pulse must last at least 250 nanoseconds

** VI = the input voltage on the pin

2. RF Module Operation

2.1. Serial Communications

The XCite OEM RF Module interfaces to a host device through a CMOS-level asynchronous serial port. Through its serial port, the XCite Module can communicate directly with any UART-interfaced or RS-232/485/422 device.

2.1.1. UART-Interfaced Data Flow

Devices that have a UART interface can connect directly through the pins of the XCite OEM RF Module as is shown in the figure below.

Figure 2-01. Data Flow in a UART-interfaced environment
(Low-asserted signals distinguished with horizontal line over signal name.)

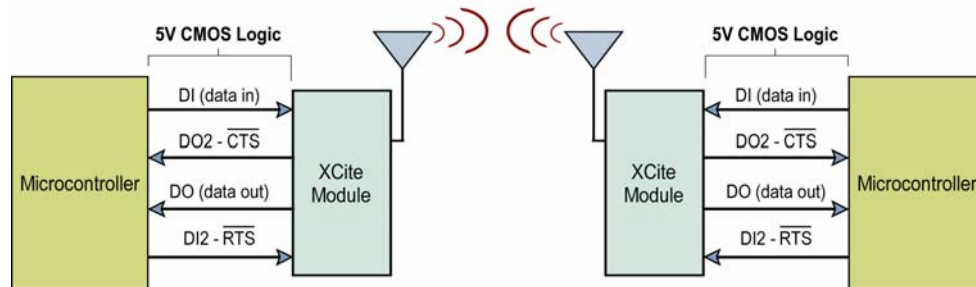

2.1.2. RS-232 and RS-485/422 Data Flow

The XCite Module can enable a host device to communicate wirelessly. To transmit, the host device simply sends serial data to the XCite Module pins. The XCite Module then converts the data into FCC-approved RF data. Once transmitted, the RF data can be detected by receiving XCite Modules, checked for integrity and then sent to a receiving device.

Figure 2-02. Data Flow in RS-232 and RS-485/422 environments.
(Low-asserted signals distinguished with a horizontal line over signal name.)

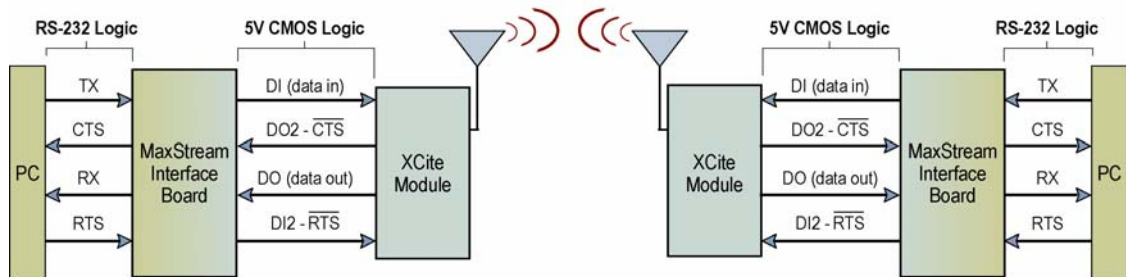

2.1.3. Serial Data

Data enters the MaxStream RF module through the DI Pin as an asynchronous serial signal. The signal should idle high when no data is being transmitted.

The UART performs tasks (such as timing and parity checking) needed for communication. Serial communication consists of two UARTs which must be configured with compatible parameters (Baud rate, parity, start bits, stop bits, data bits) to have successful communication. Each data packet consists of a start bit (low), 8 data bits (least significant bit first) and a stop bit (high). The following figure illustrates the serial bit pattern of data passing through the modem.

Figure 2-03. Serial (UART) data packet 0x1F (decimal "31") as transmitted through the XCite Module
Data Format is 8-N-1 (8 bits - No Parity - 1 Stop Bit)

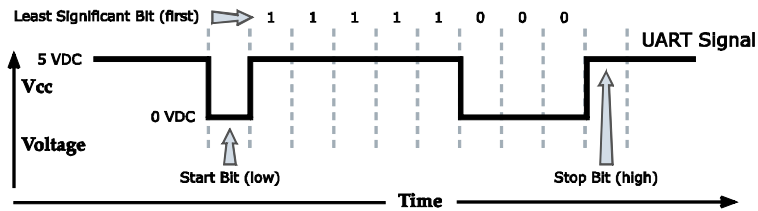

In the example above, the MaxStream RF module transfer 8 bits over-the-air [Selectable using BI (Number of Bits) Parameter]. Start and stop bits of the UART signal are not transmitted over-the-air, but are regenerated by the receiving modem.

The MaxStream OEM RF Modules support the following data formats [See NB (Parity) Parameter]:

- 8-none-1, 7-any-1
- 8-even-1
- 8-odd-1
- 8-mark-1, 8-none-2
- 8-space-1

DI (Data In) Buffer

Once serial data has entered the 9XCite Module through the Data In (DI) Pin, the data is stored in the DI Buffer until it can be transmitted.

Once the first byte of data enters the DI Buffer, the module begins to initialize the RF channel (unless RF data is being received). In the case where the module is receiving RF data, the serial (UART) data is stored in the DI Buffer. When the DI Buffer has only 17 bytes of memory left, the XCite Module de-asserts (high) $\overline{\text{CTS}}$ to signal to the host device to stop sending data. $\overline{\text{CTS}}$ re-asserts once the DI Buffer has at least 35 bytes available in memory. Once in the DI Buffer, the data is packetized for transmission.

2.2. Modes of Operation

XCite RF Modules operate in five modes.

Figure 2-04. Modes of Operation

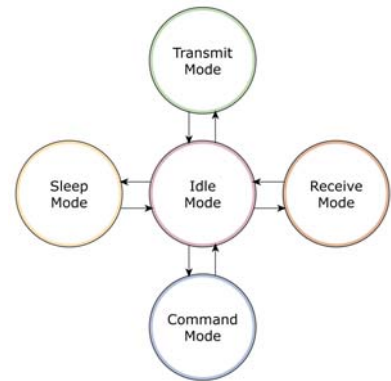

2.2.1. Idle Mode

When not receiving or transmitting data, the RF module is in Idle Mode. The module shifts into the other modes of operation under the following conditions:

- Transmit Mode (Serial data is received in the DI Buffer)
- Receive Mode (Valid RF data is received through the antenna)
- Sleep Mode (Sleep Mode condition is met)
- Command Mode (Command Mode Sequence is issued)

2.2.2. Transmit Mode

When the first byte of serial data comes through the DI Pin and arrives in the DI Buffer, the modem transitions into Transmit Mode. Once in Transmit Mode, the modem initializes a communications channel. During channel initialization, incoming serial data accumulates in the DI buffer. After the channel is initialized, data in the DI buffer is grouped into packets (up to 64 bytes in each packet) and is transmitted. The modem continues to transmit data packets until the DI buffer is empty. Once transmission is finished, the modem returns to Idle Mode. This progression is shown below:

Figure 2-05. Transmission of data

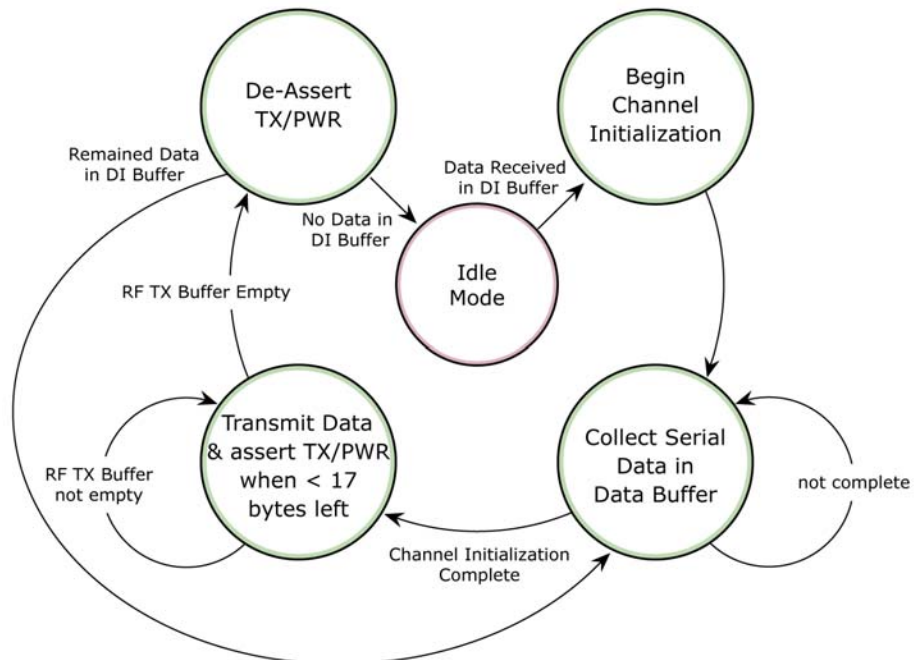

2.2.3. Receive Mode

If a modem detects RF transmitted data while operating in Idle Mode, it transitions into Receive Mode to start receiving packets. Once a packet is received, it goes through the receiving-end of a CRC (cyclic redundancy check) to ensure that the data was transmitted without error. If the CRC data bits on the incoming packet are invalid, the packet is discarded. If the CRC is valid, the packet is placed the DO Buffer. This process is shown in the figure below:

Figure 2-06. Receive Mode Data Flow

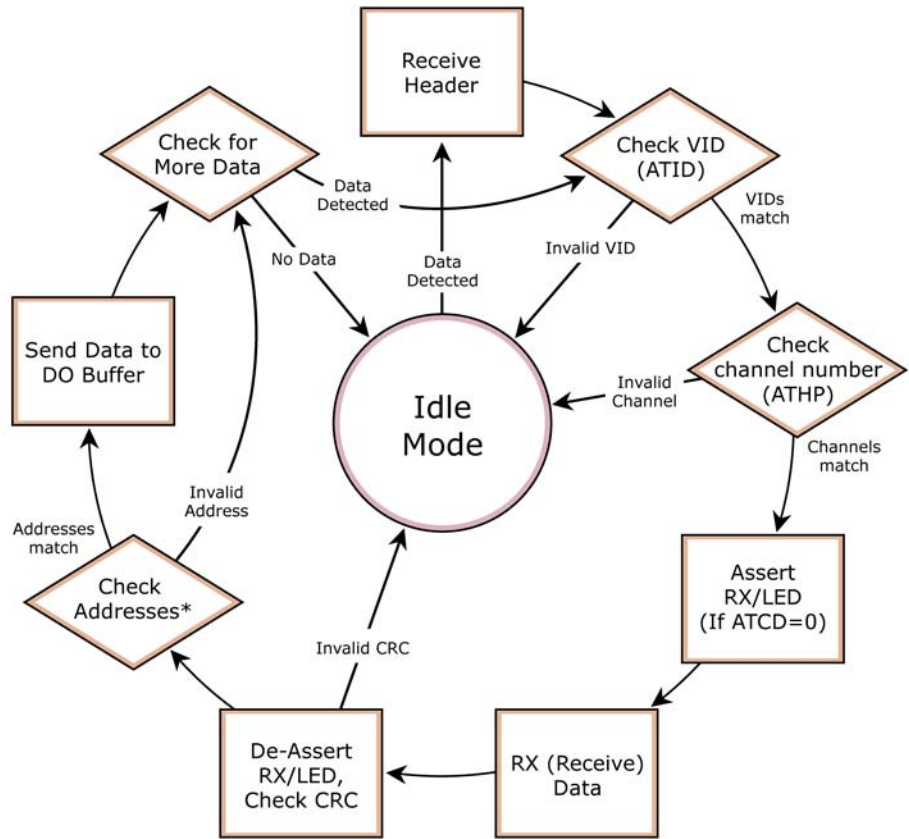

The modem returns to Idle Mode after valid data is no longer detected or once an error is detected in the received data. If serial data-to-transmit is stored in the DI buffer while the modem is giving precedence to Receive Mode, the data will be transmitted after the modem finishes receiving data and returns to Idle Mode.

2.2.4. Sleep Modes

Software Sleep

Sleep Modes enable the module to enter states of low-power consumption when not in use. Three software Sleep Modes are supported:

- Pin Sleep (Host Controlled)
- Serial Port Sleep (Wake on Serial Port activity)
- Cyclic Sleep (Wake on RF activity)

In order to enter Sleep Mode, one of the following conditions must be met (in addition to the module having a non-zero SM parameter value):

1. The module is idle (no data transmission or reception) for the amount of time defined by the ST (Time before Sleep) parameter.
2. SLEEP pin is asserted.

Once in Sleep Mode, the radio modem does not transmit or receive data until it first returns to Idle Mode. The return into Idle Mode is triggered by the de-assertion of the Sleep pin or the arrival of a serial byte through Data In pin.

The following table lists MaxStream's Sleep Mode configurations and the requirements needed to transition into and out of Sleep Mode:

Table 2-01. Sleep Mode Configurations

Sleep Mode Setting	Transition into Sleep Mode	Transition out of Sleep Mode	Related Commands	Power Consumption
Pin Sleep (SM=1)	Microcontroller can shut down and Wake-up modules. Assert (high) Sleep Pin (Pin 2). Note: Module will complete a transmission or reception before activating Pin Sleep.	De-Assert (low) Sleep pin (Pin 2)	SM	20 μ A
Serial Port Sleep (SM=2)	Automatic transition into Sleep Mode after user-defined period of inactivity (no transmitting or receiving). Period of inactivity set using ST Command.	When serial byte is received on the DI pin (Pin 4)	SM, ST	1 mA
Cyclic Sleep (SM=3-8)	Transitions into and out of Sleep Mode in cycles (user-selectable wake-up interval of time (½ second to 16 seconds) set by SM Command). The Cyclic Sleep interval time must be shorter than "Wake-up Initializer Timer" (set by LH Command). (Can be forced into Idle Mode using Sleep Pin if PW (Pin Wake-up) Command is issued.)		HT, LH, PW, SM, ST	typically 76 μ A (when sleeping)

Pin Sleep (SM = 1)

- Pin/Host-controlled

<Lowest Power Configuration> In order to achieve this low-power state, Pin 2 must be asserted (high). The modem remains in Pin Sleep until the Sleep pin is de-asserted. The modem will complete a transmission or reception before activating Pin Sleep.

After enabling Pin Sleep (SM (Sleep Mode) Parameter = 1), Pin 2 controls whether the XCite Module is active or in Sleep Mode. When Pin 2 is asserted (high), the modem transitions to Sleep Mode and remains in its lowest power-consuming state until the Sleep pin is de-asserted. The XCite Module requires 40ms to transition from Sleep Mode to Idle Mode. Pin 2 is only active if the modem is setup to operate in this mode; otherwise the pin is ignored. Once in Pin Sleep Mode, CTS is de-asserted (high), indicating that data should not be sent to the modem. The PWR pin is also de-asserted (low) when the modem is in Pin Sleep Mode

Note: The module will complete a transmission or reception before activating Pin Sleep.

Serial Port Sleep (SM = 2)

- Wake on serial port activity

Serial Port Sleep is a Sleep Mode setting in which the modem runs in a low power state until data is detected on the DI pin.

When Serial Port Sleep is enabled, the modem goes into Sleep Mode after a user-defined period of inactivity (no transmitting or receiving of data). This period of time is determined by ST (Time before Sleep) Command. The modem returns to Idle Mode once a character is received through the DI pin.

Cyclic Sleep (SM = 3-8)

Cyclic Sleep is the Sleep Mode setting in which the XCite Module enters into a low power state and awakens periodically to determine if any transmissions are being sent.

When Cyclic Sleep settings are enabled, the XCite Module goes into Sleep Mode after a user-defined period of inactivity (no transmission or reception on the RF channel). The user-defined period is determined by ST Parameter. [See ST (Time before Sleep) Parameter]

While the modem is in a low-power state, \overline{CTS} de-asserted (high) to indicate that data should not be sent to the modem during this time. When the modem awakens to listen for data, \overline{CTS} is asserted and any data received on the DI Pin is transmitted. The PWR pin is also de-asserted (low) when the modem is in Cyclic Sleep Mode. These pins are asserted each time the modem cycles into Idle Mode to listen for valid data packets and de-asserts when the modem returns to Sleep Mode.

The modem remains in Sleep Mode for a user-defined period of time ranging from 0.5 seconds to 16 seconds (SM Parameters 3 through 8). After this interval of time, the modem returns to Idle Mode and listens for a valid data packet for 100 ms. If the modem does not detect valid data (on any frequency), the modem returns to Sleep Mode. If valid data is detected, the modem transitions into Receive Mode and receives the incoming packets. The modem then returns to Sleep Mode after a Period of inactivity that is determined by ST "Time before Sleep" Parameter.

The modem can also be configured to Wake-up from cyclic sleep when the SLEEP pin is de-asserted (low). To configure a modem to operate in this manner, PW (Pin Wake-up) Command must be issued. Once the Sleep pin is de-asserted, the modem is forced into Idle Mode and can begin transmitting or receiving data. It remains active until no data is detected for the period of time specified by the ST parameter, at which point it resumes its low-power cyclic state.

Note: The cyclic interval time defined by SM (Sleep Mode) Command must be shorter than the interval time defined by LH ("Wake-up Initializer Timer") Command. For example: If SM=4 (Cyclic 1.0 second sleep), the LH Parameter should equal 0xB ("1.1" seconds). With these parameters set, there is no risk of the receiving modem being asleep for the duration of the wake-up initializer transmission. The following section "Cyclic Scanning" explains in further detail the relationship between "Cyclic Sleep" and "Wake-up Initializer Timer"

Cyclic Scanning. Each RF transmission consists of a wake-up initializer and payload data. The wake-up initializer contains initialization information and all receiving modems must Wake-up during the wake-up initializer portion of data transmission in order to synchronize with the transmitter and receive the data.

The cyclic interval time defined by the SM (Sleep Mode) command must be shorter than the interval time defined by LH (Wake-up Initializer Timer) command.

Figure 2-07. Correct Configuration (LH > SM):

The length of the wake-up initializer exceeds the time interval of Cyclic Sleep. The receiver is guaranteed to detect the wake-up initializer and receive the accompanying payload data.

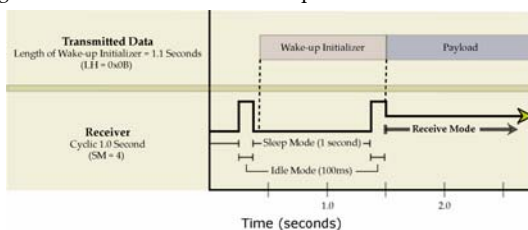

2.2.5. Command Mode

AT Command Mode provides access to AT-Settable parameters. These parameters extend flexibility in configuring modems to fit specific design criteria such as networking modems. Not all of the parameters in the XCite Module can be adjusted using AT Commands.

AT Command Mode

To Enter AT Command Mode:

1. Send the 3-character command sequence "+++" and observe guard times before and after the command characters. [refer to 'Default AT Command Mode Sequence' below.] The 'Terminal' tab (or other serial communications software) of the X-CTU Software can be used to enter the sequence.
[OR]
2. Assert (low) the CONFIG pin and turn the power going to the RF modem off and back on. To achieve this result, simultaneously press the Reset and Config switches [Figure 1-02]; release the Reset Switch; then after 1 second, release the Config Switch. The RF Modem then enters AT Command Mode at the modem's default baud rate

Default AT Command Mode Sequence (for transition to Command Mode):

- No characters sent for one second [refer to the BT (Guard Time Before) Command]
- Input three plus characters ("+++") within one second [refer to the CC (Command Sequence Character) Command.]
- No characters sent for one second [refer to the AT (Guard Time After) Command.]

All of the parameter values in the sequence can be modified to reflect user preferences.

To Send AT Commands:

Send AT commands and parameters using the syntax shown below.

Figure 2-08. Syntax for sending AT Commands

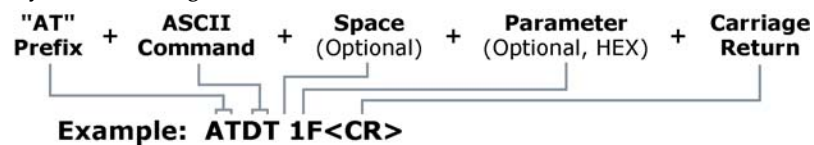

To read a parameter value stored in the module register, leave the parameter field blank.

The preceding example would change the module's Destination Address to "0x1F". To store the new value to non-volatile (long term) memory, the Write (ATWR) command must subsequently be sent before powering off the module.

System Response. When a command is sent to the module, the module will parse and execute the command. Upon successful execution of a command, the module returns an "OK" message. If execution of a command results in an error, the module returns an "ERROR" message.

To Exit AT Command Mode:

1. If no valid AT Commands are received within the time specified by CT (Command Mode Timeout) Command, the module automatically returns to Idle Mode.
[OR]
2. Send ATCN (Exit Command Mode) Command.

For an example of programming the RF module using AT Commands and descriptions of each configurable parameter, refer to the "RF Module Configuration" chapter.

3. RF Module Configuration

The following versions of the XCite RF Modem are available:

- 900 MHz, 9600 Baud (RF data rate), Hopping Channel Mode
- 900 MHz, 9600 Baud, Single Channel mode
- 900 MHz, 38400 Baud, Hopping Channel mode
- 900 MHz, 38400 Baud, Single Channel mode

XCite Modems can operate in both Single Channel and Hopping modes. Mode is selectable using the "Function Set" dropdown list of the "XCite Configuration" tab of the MaxStream-provided X-CTU Software.

The XCite Module is shipped with a unique parameter set in its memory. Parameters within the set are organized under the following categories: AT Commands & Non-AT Settable Parameters.

3.1. Command and Parameter Types

3.1.1. AT Commands

AT Commands can be changed at any time by entering AT Command Mode and sending commands to the modem.

AT Commands can be modified using the any of the following means:

- X-CTU Software "Modem Configuration" tab
- X-CTU Software "Terminal" tab
- Terminal software program (such as "HyperTerminal")
- Microcontroller

3.1.2. Non-AT Settable Parameters (X-CTU Software configurable only)

Non-AT Settable Parameters can only be adjusted using the MaxStream-provided X-CTU Software. To modify Non-AT Settable Parameter, connect the module to the serial com port of a PC (interface board is necessary for RS-232 connection) and modify parameter values through the X-CTU Software interface. These parameters enable features that need to be set before the module is used in the field.

Non-AT Settable Parameters can only be modified using the following means:

- X-CTU Software "Modem Configuration" tab

3.2. Configuration Software

X-CTU is a MaxStream-provided software program used to interface with and configure Max-Stream RF Modules. The software application is organized into the following four tabs:

- PC Settings tab - Setup PC serial ports for interfacing with an RF module
- Range Test tab - Test the RF module's range and monitor packets sent and received
- Terminal tab - Set and read RF module parameters using AT Commands
- Modem Configuration tab - Set and read RF module parameters

Figure B-1. X-CTU User Interface (PC Settings, Range Test, Terminal and Modem Configuration tabs)

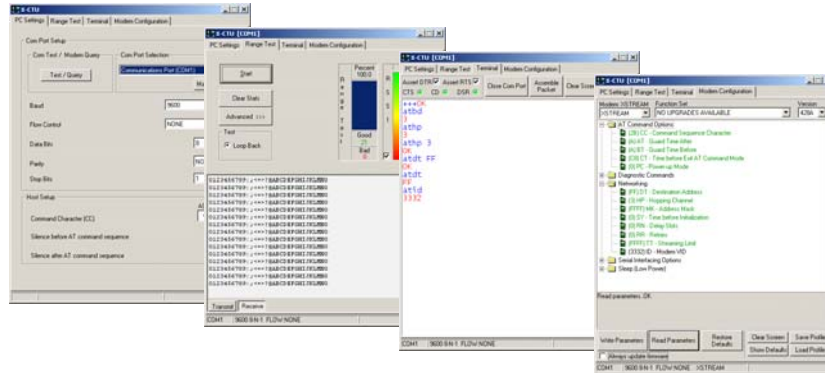

NOTE: PC Setting values are visible at the bottom of the Range Test, Terminal and Modem Configuration tabs. A shortcut for editing PC Setting values is available by clicking on any of the values.

Installation

Double-click the "setup_X-CTU.exe" file and follow prompts of the installation screens. This file is located in the 'setup' folder of the MaxStream CD and also under the 'Downloads' section of the following web page: www.maxstream.net/support/downloads.php

Setup

To use the X-CTU software, a module assembly (An RF module mounted to an interface Board) must be connected to a serial port of a PC.

NOTE: Failure to enter AT Command Mode is most commonly due to baud rate mismatch. The interface data rate and parity settings of the serial port ("PC Settings" tab) must match those of the module (BD (Baud Rate) and NB (Parity) parameters respectively).

Serial Communications Software

A terminal program is built into the X-CTU Software. Other terminal programs such as "HyperTerminal" can also be used to configure modules and monitor communications. When issuing AT Commands through a terminal program interface, use the following syntax:

Figure B-2. Syntax for sending AT Commands

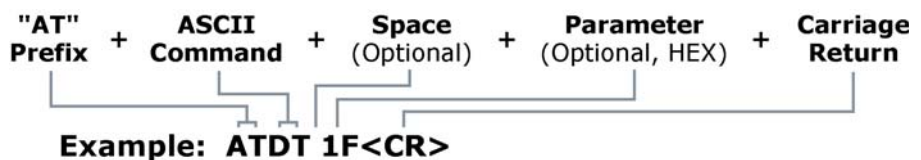

NOTE: To read a parameter value stored in a register, leave the parameter field blank.

The example above issues the DT (Destination Address) command to change destination address of the module to "0x1F". To save the new value to the module's non-volatile memory, issue WR (Write) command after modifying parameters.

3.3. Command Reference Tables

XCite AT Commands [below] and Non-AT Settable Parameters [next page] are organized under the following

command categories:

- AT Command Mode Options
- Diagnostic
- Networking
- Serial Interfacing
- Sleep Mode (Low Power)

Table 3-01. AT Commands

(Settable/Readable using X-CTU Software, serial communications software or microcontroller)

AT Designator	Command Name & Description	Parameter Range	Command Category	# Bytes Returned	Factory Default
CD	DI3 Configuration. Redefines the RX LED I/O line (RX LED signal).	0 – 2 0 = RX LED 1 = high 2 = low	Serial Interfacing	1	0
CN	Exit AT Command Mode. Explicitly exit radio modem from AT Command Mode and return it to Idle Mode.	--	AT Command Mode Options	--	--
CS	DO2 Configuration. Select behavior of DI2 (Digital Output 2) between CTS and RS-485 options.	0 – 4 0 = normal CTS 1 = RS-485 enable low 2 = high 3 = RS-485 enable high 4 = low	Serial Interfacing	1	0
DB	Receive Signal Strength. Returns the signal strength (in decibels) of the last received packet.	0x25 – 0x6A [Read-only]	Diagnostic	1	--
DT	Destination Address. Set the address that identifies the destination of the RF packet. Only radio modems having matching addresses can communicate with each other.	0 – 0xFFFF	Networking	2	0
FH	Force Wake-up Initializer. Force a Wake-up Initializer to be sent on the next transmission. WR (Write) Command does not need to be issued with FH Command. Use only with cyclic sleep modes (SM = 3-8) active on remote modems.	--	Sleep (Low Power)	--	--
HP	Channel *. Select "Hopping" or "Single Frequency" channel on which the radio modem is to communicate. Channels are not noninterfering.	Hopping: 0 – 6 Single Frequency): 0 – 0x18	Networking	1	0
HV	Hardware Version. Read the hardware version of the modem.	Range: 0 – 0xFFFF [Read-only]	Diagnostic	2	--
MK	Address Mask. Set address mask to configure local and global address space.	0 – 0xFFFF	Networking	2	0xFFFF (65535d)
RE	Restore Defaults. Restore AT-settable parameters to the factory default configuration.	--	(Special)	--	--
SH	Serial Number High. Read High 16 bits of unique serial number of radio modem.	0 – 0xFFFF [Read-only]	Diagnostic	2	--
SL	Serial Number Low. Read Low 16 bits of unique serial number of radio modem.	0 – 0xFFFF [Read-only]	Diagnostic	2	--
VR	Firmware Version. Read firmware version currently loaded on radio modem.	0 – 0xFFFF [Read-only]	Diagnostic	2	--
WR	Write. Write parameters to radio modem's non-volatile memory in order for changes to persist through next power-up or reset.	--	(Special)	--	--

Table 3-02. Non-AT Settable Parameters

(Settable/Readable using the X-CTU Software “Modem Configuration” tab only)

AT Designator	Command Name & Description	Parameter Range	Command Category	# Bytes Returned	Factory Default
AT	Guard Time After. Set required DI pin silent time after the Command Sequence Characters of the AT Command Mode Sequence (BT+ CC + AT).	0x02 – 0xFFFF [x 1 ms]	AT Command Mode Options	2	0x1F4 (500d)
BD	Interface Data Rate. Set serial data rate (baud rate at which radio modem interfaces with host). Serial data rate is different than RF data rate which is fixed and factory-set. If the serial data rate is set higher than RF data rate, flow control may need to be observed to prevent DI buffer overrun.	0 – 6 (1200 - 57600 bps)	Serial Interfacing	1	Set to equal radio modem's fixed RF data rate.
BI	Number of Bits. (7 or 8) – Sets number of data bits per character (bits between start and stop bits).	0 – 1 0 = 7 bits 1 = 8 bits	Serial Interfacing	1	1
BT	Guard Time Before. Set required DI pin silent time before the Command Sequence Characters of the Command Mode Sequence (BT+ CC + AT).	0 – 0xFFFF [x 1 ms]	AT Command Mode Options	2	0x1F4 (500d)
CC	Command Sequence Character. Set the ASCII character to be used between Guard Times of the AT Command Mode Sequence (BT+ CC + AT). The AT Command Mode Sequence enters the radio modem to AT Command Mode (from Idle Mode).	0x20 – 0x7F	AT Command Mode Options	1	0x2B (plus sign (+) in ASCII)
CT	Time before Exit AT Command Mode. Set time period of inactivity (no valid commands received) after which radio modem automatically exits from AT Command Mode.	0x02 – 0xFFFF [x 100 ms]	AT Command Mode Options	2	0xC8 (200d)
FL	Software Flow Control. Enable serial software flow control on the radio modem. (Hardware flow control (CTS) is on by default.)	0 - 1 0 = disable 1 = enabled	Serial Interfacing	1	0
HT	Time before Wake-up Initializer. Set time period of inactivity (no serial or RF data is sent or received) before a Wake-up Initializer is sent. Base station tracks awake-status of remote radios. HT of base radio should be set shorter than ST of remote radios.	0 – 0xFFFF [x 100 ms]	Sleep (Low Power)	2	0xFFFF (no wake-up Initializer will be sent)
ID	Modem VID. Read radio modem VID (Vendor Identification Number). Only radio modems with matching VIDs can communicate with each other.	0 – 0x7FFF (above this range is Read-only)	Networking	2	0x3332
LH	Wake-up Initializer Time. Set time of the Wake-up Initializer used to wake remote radios that are in cyclic sleep mode. Time of Wake-up Initializer should be longer than that of the remote radio's cyclic sleep cycle (SM 3 - 8).	0 – 0xFF [x 100 ms]	Sleep (Low Power)	1	1
NB	Parity. Select parity format. Settings 0-4 transfer only 8 bits out the antenna port and generate the parity bit on the radio modem receiving side.	0 – 4 0 = 8-none-1, 7-any-1 1 = 8-even-1 2 = 8-odd-1 3 = 8-mark-1, 8-none-2 4 = 8-space-1	Serial Interfacing	1	0
PW	Pin Wake-up. Enable pin wake-up from Cyclic Sleep Mode.	0 – 1 0 = disabled 1 = enabled	Sleep (Low Power)	1	0
RT	DI2 Configuration. Enable $\overline{\text{RTS}}$ Mode	0 - 1 0 = Disabled 1 = RTS flow control	Serial Interfacing	1	0
SB	Stop Bits. Set number of stop bits.	0 – 1 0 = 1 stop bit 1 = 2 stop bits	Serial Interfacing	1	0
SM	Sleep Mode. Specify Sleep Mode settings.	0 – 8 0 = No sleep 1 = Pin Sleep 2 = Serial Port Sleep 3 to 8 = Cyclic intervals ranging from 0.5 to 16.0 seconds	Sleep (Low Power)	1	0
ST	Time before Sleep. Set time period of inactivity (no serial or RF data is sent or received) before activating Sleep Mode. Use with Cyclic Sleep and Serial Port Sleep [refer to SM Command]	0x10 – 0xFFFF [x 100 ms]	Sleep (Low Power)	2	0x64 (100d)

3.4. Automatic DIP Switch Configurations

Each time the RF Modem is powered-on, intelligence on the Max-Stream Interface Board (located inside the RF Modem) sends AT Commands that program the modem based on positions of the DIP Switch. Automatic configurations that take place during the power-on sequence affect RF Modem parameter values as shown below.

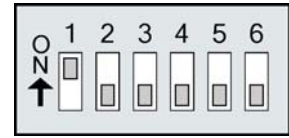

To avoid overwriting previously stored custom configurations (due to the automatic configurations that take place each time the RF Modem is powered-on), it is necessary to disable a processor located on the XIB-R interface board. To disable the processor, populate J7 of the XIB-R Interface Board. (By default, J7 jumper is not populated.)

Table 3-03. RF Modem Power-up Options (J7 jumper and Config Switch)

Condition	Behavior
If J7 is populated	Processor is disabled and AT Commands are not sent to the RF Modem
If Config Switch is pressed	Processor is disabled and RF Modem enters into AT Command Mode
If J7 is NOT populated and Config Switch is NOT pressed	Execute logic as shown in Table 6.

AT Commands Sent as result of DIP Switch Settings (SW = DIP Switch)

Condition	Behavior
Serial Interfacing Options	
If SW1 is ON (up)	AT Commands sent: ATCS 0 (RS-232 Operation: $\overline{\text{CTS}}$ function for $\overline{\text{CTS}}$ line) ATCD 2 (DO3 - RX LED = low)
If SW1 is OFF (down)	AT Commands sent: ATCS 3 (RS-485 or RS-422 Operation) ATCD 2 (DO3 - RX LED = low)
Exit AT Command Mode	
Always	AT Commands sent: ATCN (Exit AT Command Mode)

3.5. Command Descriptions

Commands and parameters are listed alphabetically. Parameter types and categories are designated between "< >" symbols. For example: <AT Command: Networking>. "AT Command" is the command/parameter type and "Networking" is the command/parameter category.

AT (Guard Time After) Parameter

<Non-AT Settable Parameter: AT Command Options> AT Parameter is used to set the DI pin silent time that follows the command sequence character (CC Parameter). By default, 1 half of a second (500 milliseconds) must elapse before entering another character. The AT Command Mode Sequence used to enter AT Command Mode is as follows:

"No characters sent for 1 millisecond [BT (Guard Time Before) Parameter]

"Send three plus characters "+++ " [CC (Command Sequence Character) Parameter]

"No characters sent for 1 millisecond [AT (Guard Time After) Parameter]

All of the values in this sequence can be adjusted. AT Parameter is used to adjust the period of silence that follows the command sequence character.

Parameter Range: 0x02 - 0xFFFF (x 1 millisecond)

of bytes returned: 2

Default Parameter Value: 0x1F4 (500 decimal)

Related Commands: BT (Guard Time Before), CC (Commands Sequence Character)

BD (Interface Data Rate) Parameter

<Non-AT Settable Parameter: Serial Interfacing> BD Parameter allows the user to adjust the UART baud rate and thus modify the rate at which serial data is sent to the modem. Baud rates range from 1200 to 57600 baud (bps). The new baud rate does not take effect until CN (Exit AT Command Mode) Command is issued.

Note: If the serial data baud rate is set to exceed the fixed RF data baud rate of the XCite radio modem, flow control may need to be implemented.

Parameter Ranges: 0 – 6

Parameter	Configuration (bps)
0	1200
1	2400
2	4800
3	9600
4	19200
5	38400
6	57600

Default Parameter Value: Set to equal radio modem's fixed RF data rate (baud)

Number of bytes returned: 1

BI (Number of Bits) Parameter

<Non-AT Settable Parameter: Serial Interfacing> BI Parameter allows the user to define the number of data bits between the start and stop bits. Setting 7 bits and Mark or Space parity (NB Parameter) will result in a setting of 7 bits and no parity.

Parameter Ranges: 0 – 1

Parameter	Configuration
0	7 bits
1	8 bits

Default Parameter Value: 1

Number of bytes returned: 1

BT (Guard Time Before) Parameter

<Non-AT Settable Parameter: AT Command Options> BT Parameter is used to set the DI pin silent time that precedes the command sequence character (CC Parameter). By default, 1 half of a second (500 milliseconds) must elapse before entering another character. The AT Command Mode Sequence used to enter AT Command Mode is as follows:

"No characters sent for 1 millisecond [BT (Guard Time Before) Parameter]
 "Send three plus characters "+++" [CC (Command Sequence Character) Parameter]
 "No characters sent for 1 millisecond [AT (Guard Time After) Parameter]

All of the values in this sequence can be adjusted. AT Command is used to adjust the period of silence that precedes the command sequence character.

Parameter Range: 0 - 0xFFFF (x 1 millisecond)

of bytes returned: 2

Default Parameter Value: 0x1F4 (500 decimal)

Related Commands: AT (Guard Time After), CC (Commands Sequence Character)

CC (Command Sequence Character) Parameter

<Non-AT Settable Parameter: AT Command Options> CC Parameter is used to adjust the command sequence character used when entering AT Command Mode.

The AT Command Mode Sequence used to enter AT Command Mode is as follows:

"No characters sent for 1 millisecond [BT (Guard Time Before) Parameter]
 "Send three plus characters "+++" [CC (Command Sequence Character) Parameter]
 "No characters sent for 1 millisecond [AT (Guard Time After) Parameter]

Parameter Range: 0x20 - 0x7F

of bytes returned: 1

Default Parameter Value: 0x2B (ASCII "+" sign)

Related Parameters: AT (Guard Time After), BT (Guard Time Before)

CD (DO3 Configuration) Command

<AT Command: Serial Interfacing> Used to redefine the RX LED I/O line.

AT Command: ATCD

Parameter Ranges: 0 - 2

Parameter	Configuration
0	RX LED
1	High
2	Low

Default Parameter Value: 0

Number of bytes returned: 1

CN (Exit AT Command Mode) Command

<AT Command: AT Command Mode Options> CN Command allows users to explicitly exit AT Command Mode and return the radio modem into Idle Mode.

AT Command: CN

CS (DO2 Configuration) Command

<AT Command: Serial Interfacing> CS Command is used to modify the behavior of the CTS signal such that it either provides RS-232 flow control, enables RS-485 transmission / reception or determines RS-422 transmit enable. By default, CTS provides RS-232 flow control. CS Parameter must be adjusted for the modem to operate in RS-485/422 environments.

AT Command: ATCS

Parameter Ranges: 0 – 4

Parameter	Configuration
0	Normal CTS
1	RS-485 enable (low)
2	high
3	RS-485 enable (high)
4	low

Default Parameter Value: 0

Number of bytes returned: 1

CT (Time before Exit AT Command Mode) Parameter

<Non-AT Settable Parameter: AT Command Options> AT Command Mode can be exited manually using CN (Exit AT Command Mode) Command or, after a given time of inactivity, the modem exits AT Command Mode on its own and return to Idle Mode. CT Command sets the amount of time before AT Command Mode is exited automatically. If no characters are received before this time elapses, the modem will return to Idle Mode.

Parameter Range: 0x02 - 0xFFFF [x 100 ms]**# of bytes returned:** 2**Default Parameter Value:** 0xC8 (200d (20 decimal seconds))**DB (Receive Signal Strength) Command**

<AT Command: Diagnostic> DB Parameter returns the receive signal strength (in decibels) of the last received packet. This Parameter is useful in determining range characteristics of the XCite Modules under various conditions.

AT Command: DB

Parameter Range: 0x25 - 0x6A [Read-only]

of bytes returned: 1

DT (Destination Address) Command

<AT Command: Networking> DT Command is used to set the address of the XCite Radio Modem. XCite Radio Modems use three network layers - the Vendor Identification Number (ATID), Channels (ATHP) and Destination Addresses (ATDT).

DT Command assigns an address to a radio modem that enables it to communicate only with radio modems that have matching addresses. This is similar to interconnecting several PCs under a common hub. All radio modems that share the same destination address can communicate freely with each other. Radio Modems in the same network with a different destination address (than that of the transmitter) will listen to all transmissions to stay synchronized, but will not send any of the data out their serial ports.

AT Command: DT**Parameter Range:** 0 - 0xFFFF**# of bytes returned:** 2**Default Parameter Value:** 0**Related Commands:** ID (Modem ID), HP (Channel), MK (Address Mask)

FH (Force Wake-up Initializer) Command

<AT Command: Sleep (Low Power)> FH Command is used to force a Wake-up Initializer to be sent on the next transmission. WR (Write) Command does not need to be issued with FH Command. Use only with cyclic sleep modes active on remote modems.

AT Command: FH

FL (Software Flow Control) Parameter

<Non-AT Settable Parameter: Serial Interfacing> FL Parameter is used to adjust serial flow control. Hardware flow control is implemented with the XCite Radio Modem as the CTS pin (which regulates when serial data can be transferred to the radio modem). FL Parameter can be used to allow software flow control to also be enabled. The XON character to use is 0x11 ("17" decimal). The XOFF character to use is 0x13 ("19" decimal).

Parameter Ranges: 0 – 1

Parameter	Configuration
0	No Software Flow Control
1	Use Software Flow Control

Default Parameter Value: 0

Number of bytes returned: 1

HP (Channel) Command

<AT Command: Networking> HP Command is used to set the radio modem channel number. A channel is one of three layers of addressing available to the XCite Radio Modem. In order for radio modems to communicate with each other, the modems must have the same channel number since each channel uses a different hopping sequence or single frequency. Different channels can be used to prevent modems in one network from listening to transmissions of another.

The XCite Radio Modem can operate both in Hopping and Single Frequency Channel Modes. Switching between Single Channel and Hopping Modes can only be done only using the "Function Set" dropdown list on the "Modem Configuration" tab of the X-CTU Software

A "Hopping Channel" is a channel comprised of a group of frequencies. When in Hopping Channel Mode, the radio modem hops between the frequencies them when transmitting data. This option utilizes FHSS (Frequency Hopping Spread Spectrum) technology. This option helps bolster security in wireless data communications and also makes the system less prone to interference.

The 25 center frequencies available in Single Frequency Channel Mode are spaced 300 KHz apart. Since each channel occupies a 500 KHz bandwidth, adjacent channels therefore overlap. If modems are used in the same vicinity but on different channels, the channels used should occupy every other channel at a minimum separation. If channels used on different radio modems can be separated more they should be. This will provide for more isolation and less interference.

AT Command: ATHP

Parameter Range (Hopping Mode): 0 – 6

Parameter Range (Single Frequency Mode): 0 – 0x18 [refer to rows below]

Parameter	Frequency (MHz)
0x00	910.5
0x01	910.8
0x02	911.1
0x03	911.4
0x04	911.7
0x05	912.0
0x06	912.3
0x07	912.6
0x08	912.9
0x09	913.2
0x0A	913.5
0x0B	913.8
0x0C	914.1
0x0D	914.4
0x0E	914.7
0x0F	915.0
0x10	915.3
0x11	915.6
0x12	915.9
0x13	916.2
0x14	916.5
0x15	916.8
0x16	917.1
0x17	917.4
0x18	917.7

Default Parameter Value: 0

Number of bytes returned: 1

HT (Time before Wake-up Initializer) Parameter

<Non-AT Settable Parameter: Sleep (Low Power)> If any modems within range are running in a "Cyclic Sleep Setting", a wake-up initializer must be sent by the transmitter for the other radio modems to synchronize to the transmitter [see LH ("Wake-up Initializer Timer") Command]. When a receiving radio modem in Cyclic Sleep wakes, it must detect the wake-up initializer portion of the RF packet in order to synchronize to the transmitter and receive data. HT Parameter sets time period of inactivity (no serial or RF data is sent or received) before a Wake-up Initializer is sent. Base station tracks awake-status of remote radios. HT of base radio should be set shorter than ST (Time before Sleep) of remote radios.

From the receiver perspective, after "HT" time elapses and the ST (Time before Sleep) Parameter is met, the receiver goes into cyclic sleep. Once in cyclic sleep, the radio modem must first detect the wake-up initializer and synchronize to the transmitter before it can receive data. Thus, when time "HT" time elapses, the transmitter then knows it needs to send a long wake-up initializer for all receivers to be able to synchronize to its next transmission. Matching "HT" to the "ST" time on the receiver(s) guarantees that all receivers will detect the next transmission.

Parameter Range: 0 - 0xFFFF [x 100 ms]

of bytes returned: 2

Default Parameter Value: 0xFFFF (long wake-up initializer will not be sent)

Related Parameters: LH (Wake-up Initializer Timer), SM (Sleep Mode), ST (Time before Sleep)

HV (Hardware Version) Command

<AT Command: Diagnostic> Reads and returns the hardware version of the module.

AT Command: HV

Parameter Range: 0 - 0xFFFF [Read-only]

of bytes returned: 2

ID (Modem VID) Parameter

<Non-AT Settable Parameter: Networking> ID Parameter reads and edits the module's VID. VID is a MaxStream-specific acronym that stands for "Vendor Identification Number". RF modules can only communicate with other modems having the same VID.

Parameter Range: 0 - 0x7FFF (above this range is Read-only)

of bytes returned: 2

Default Parameter Value: 0x3332

LH (Wake-up Initializer Timer) Parameter

<Non-AT Settable Parameter: Sleep (Low Power)> LH Parameter adjusts the duration of time in which the wake-up initializer is sent. When receiving modems are put into the Cyclic Sleep Mode, they power-down after a period of inactivity (specified by ST (Time before Sleep) Parameter) and will periodically awaken and listen for transmitted data. In order for the receiving modems to initialize with the transmitter, they must detect ~35ms of the wake-up initializer. LH Parameter must be used whenever a receiver is operating in Cyclic Sleep Mode. This lengthens the wake-up initializer to a specific amount of time (in x 100 ms). The long wake-up initializer must be longer than the cyclic sleep time that is determined by SM (Sleep Mode) Command. If the wake-up initializer time were less than the Cyclic Sleep interval, the connection would be at risk of missing the wake-up initializer transmission. The following data and figures illustrate this behavior:

Parameter Range: 0 - 0xFF [x 100 ms]

of bytes returned: 1

Default Parameter Value: 0x01 (0.1 second)

Related Parameters: HT (Time before Wake-up Initializer), SM (Sleep Mode), ST (Time before Sleep)

Figure 3-01. Correct Configuration (LH > SM)

The length of the wake-up initializer exceeds the time interval of Cyclic Sleep. The receiver is guaranteed to detect the wake-up initializer and receive the accompanying payload data.

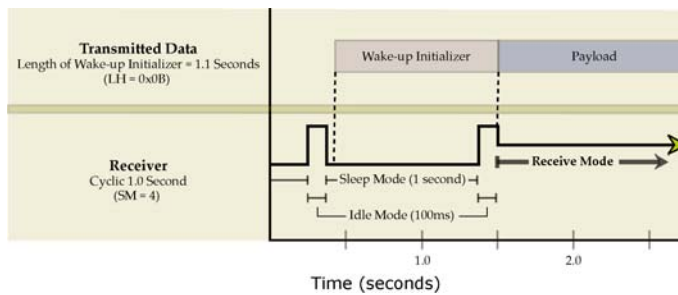
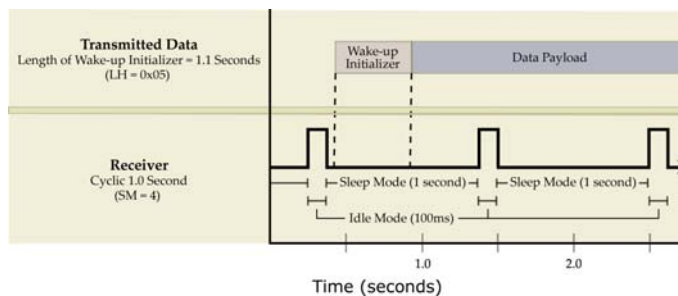

Figure 3-02. Incorrect Configuration (LH < SM)

The length of the wake-up initializer is shorter than the time interval of Cyclic Sleep. This configuration is vulnerable to the receiver waking and missing the wake-up initializer (and therefore also the accompanying payload data).



MK (Address Mask) Command

<AT Command: Networking> MK Command is used to set the radio modem address mask. All RF packets contain the Destination Address of the transmitting radio modem. When an RF packet is received, the transmitter's Destination Address is logically "ANDed" (bitwise) with the Address Mask of the receiver. The resulting value must match the Destination Address or the Address Mask of the receiver for the packet to be received and sent out the receiving modem serial port. If the "ANDed" value does not match either the Destination Address or the Address Mask of the receiver, the packet is discarded. (All "0" values are treated as "irrelevant" values and ignored.)

AT Command: MK

Parameter Range: 0 - 0xFFFF

of bytes returned: 2

Default Parameter Value: 0xFFFF (When set to this value, the Destination Address of the transmitter must exactly match the Destination Address of the receiver.)

Related Commands: DT (Destination Address), HP (Channel)

NB (Parity) Parameter

<Non-AT Settable Parameter: Serial Interfacing> NB Parameter allows parity for the modem to be changed. Parity is an error detection method in which a bit (0 or 1) is added to each group of bits so that it will have either an odd number of 1's or an even number of 1's. For example, if parity is odd, then any group of bits that arrives with an even number of 1's must contain an error.

Parameter Ranges: 0 - 4

Parameter	Configuration
0	8-bit (no parity) or 7-bit (with any parity)
1	8-bit even parity
2	8-bit odd parity
3	8-bit mark parity
4	8-bit space parity

Default Parameter Value: 0

Number of bytes returned: 1

PW (Pin Wake-up) Parameter

<Non-AT Settable Parameter: Sleep (Low Power)> Under normal operation, a radio modem in Cyclic Sleep Mode cycles from an active state to a low-power state at regular intervals until data is ready to be received. If PW Parameter is set to 1, the SLEEP Pin (Pin 2 of the embedded OEM RF Module) can be used to awaken the modem from Cyclic Sleep. If the SLEEP Pin is de-asserted (low), the radio modem will be fully operational and will not go into Cyclic Sleep. Once SLEEP is asserted, the radio modem will remain active for the period of time specified by ST (Time before Sleep) Command, and will return to Cyclic Sleep Mode (if no data is ready to be transmitted). PW Command is only valid if Cyclic Sleep has been enabled using SM Command.

Parameter Ranges: 0 - 1

Parameter	Configuration
0	disabled
1	enabled

Default Parameter Value: 0

Number of bytes returned: 1

RE (Restore Defaults) Command

<AT Command: AT Command Options> RE Command restores all AT-settable parameters to factory default settings. However, RE Command will not write the default values to non-volatile memory. Unless the WR (Write) Command is issued after the RE Command, the default settings will not be saved in the event of radio modem reset or power-down.

AT Command: RE

Related Command: WR (Write)

RT (DI2 Configuration) Parameter

<Non-AT Settable Parameter: Serial Interfacing>
RT Parameter enables RTS Mode.

Parameter Ranges: 0 – 1

Parameter	Configuration
0	disabled
1	Enables RTS Handshaking

Default Parameter Value: 0

Number of bytes returned: 1

SB (Stop Bits) Parameter

<Non-AT Settable Parameter: Serial Interfacing>
SB Parameter allows the user set the number of stop bits used in data transmission.

Parameter Ranges: 0 – 1

Parameter	Configuration
0	1 stop bit
1	2 stop bits

Default Parameter Value: 0

Number of bytes returned: 1

SH (Serial Number High) Command

<AT Command: Diagnostic> SH Command reads and returns the RF module serial number high word.

AT Command: SH

Parameter Range: 0 - 0xFFFF [Read-only]

of bytes returned: 2

Related Command: SL (Serial Number Low)

SL (Serial Number Low) Command

<AT Command: AT Command Options> SL Command reads and reports the RF module serial number low word.

AT Command: SL

Parameter Range: 0 - 0xFFFF [Read-only]

of bytes returned: 2

Related Command: SH (Serial Number High)

SM (Sleep Mode) Parameter

<Non-AT Settable Parameter: Sleep Mode (Low Power)> SM Parameter is used to adjust Sleep Mode settings. By default, Sleep Mode is disabled and the radio modem remains continually active. SM Parameter allows the radio modem to run in a lower-power state and be configured in one of eight settings.

Cyclic Sleep settings wake the radio modem after the amount of time designated by SM Command. If the radio modem detects a wake-up initializer during the time it is awake, it will synchronize with the transmitting radio modem and start receiving data after the wake-up initializer runs its duration. Otherwise, it returns to Sleep Mode and continue to cycle in and out of sleep until the wake-up initializer is detected. If a Cyclic Sleep setting is chosen, the ST, LH and HT parameters must also be set as described in the "Sleep Mode" section of this manual.

Parameter Ranges: 0 – 8

Parameter	Configuration
0	No Sleep
1	Pin Sleep
2	Serial Port Sleep
3	Cyclic 0.5 seconds
4	Cyclic 1.0 seconds
5	Cyclic 2.0 seconds
6	Cyclic 4.0 seconds
7	Cyclic 8.0 seconds
8	Cyclic 16.0 seconds

Default Parameter Value: 0

Number of bytes returned: 1

ST (Time before Sleep) Parameter

<Non-AT Settable Parameter: Sleep Mode (Low Power)> ST Parameter sets the period of time (in tenths of seconds) in which the radio modem remains inactive before entering into Sleep Mode. For example, if the ST Parameter is set to 0x64 ("100" decimal), the radio modem will enter into Sleep Mode after 10 seconds of inactivity (no transmitting or receiving). This command can only be used if either Cyclic Sleep or Serial Port Sleep Mode settings have been selected using SM (Sleep Mode) Parameter.

Parameter Range: 0x10 - 0xFFFF [x 100 ms]

of bytes returned: 2

Default Parameter Value: 0x64 ("100" decimal)

Related Parameters: SM (Sleep Mode), LH (Wake-up Initializer Timer), HT (Time before Wake-up Initializer)

VR (Firmware Version) Command

<AT Command: AT Command Options> Reads and returns the currently loaded firmware version of the XCite Radio Modem.

AT Command: VR

Parameter Range: 0 - 0xFFFF [Read-only]

of bytes returned: 2

WR (Write) Command

<AT Command: (Special)> WR Command writes all configurable parameters to non-volatile memory. Using WR Command saves parameters to the radio modem's persistent memory. (This means that the parameters remain in the radio modem's memory until explicitly overwritten by future uses of WR Command.)

AT Command: WR

4. Advanced Networking

4.1. Addressing

XCite radio modems utilize three layers of addressing to communicate between radio modems. The network layers are depicted below. Only radio modems with the matching addresses are able to communicate. The main layers of XCite Networking and Addressing are:

- Vendor Identification Number (ATID)
- Channel (ATHP)
- Destination Address (ATDT)

Figure 4-01. Addressing layers contained in the RF packet header

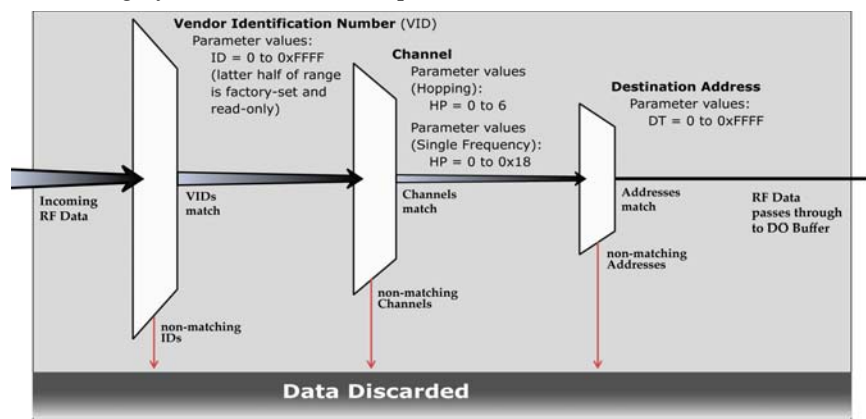

Each network layer provides a separate layer of filtration. The Vendor Identification Number (VID) provides the first layer of filtration through the ID (Modem ID) Parameter. If the incoming RF data carries a matching VID number, the data continues through to the subsequent Channel and Destination Address layers. The Destination Address is the last network layer and provides the most granular form of filtration. If at any point during the incoming RF data flow the numbers in question do not match, the data is discarded.

XCite Modules and RF Modems are built around a peer-to-peer protocol that inherently supports a multidrop type network (similar to RS-485). In their default state, any XCite radio modem will communicate with any other XCite radio modem in its default state.

4.1.1. Vendor Identification Number (ATID)

The bottom half of the ID (Vendor Identification Number) Parameter range is user-settable. The upper half of the range is factory-set and read-only. The value of the ID Command is called the Vendor Identification Number (VID). A unique VID is available upon special request. The VID is programmed to the XCite Module at the factory and is stored in the modem's permanent memory. Only modems with matching VIDs can communicate with each other.

VID addressing ensures that radio modems ignore transmissions and receptions of XCite Radio Modems having a different VID in the same vicinity. To request a unique VID, contact MaxStream to obtain the VID Request Form.

4.1.2. Channel (ATHP)

Channels provide a network layer from which channels can be used for isolation. HP (Channel) Parameter is used to define channel values.

Hopping Channel Mode: HP Parameter value range is 0 through 6

Single Frequency Channel Mode: HP range is 0 through 0x18 (decimal range: 0 - 24)

In "Hopping Channel Mode", each channel utilizes a different pseudo-random hopping sequence to navigate through shared hopping channels. In the event that two modems from different networks collide on a channel, the two modems will jump to separate channels on the next hop. Multiple modem pairs can operate in the same vicinity with minimal interference from each other.

4.1.3. Destination Address (ATDT) and Address Mask (ATMK)

XCite Destination Addresses and Masks provide the means to set up global or local addresses for establishing modem groups, subnets, etc. The Destination Address network layer provides for more granular isolation of radio modems. The XCite Destination Addresses and Masks can be used to:

- Set up point-to-point and point-to-multipoint network configurations
- Provide greater flexibility in establishing modem groups, subnets, etc.

Each radio modem in a network can be configured with a 16-bit Destination Address to establish selective communications within a network. This address is set to one of 65535 values using DT (Destination Address) Command. The default Destination Address is 0.

All radio modems with the same Destination Address can transmit and receive data among themselves. Radio modems having different Destination Addresses still detect and listen to the data (in order to maintain network synchronization); however, the data is discarded rather than passing on through the DO pin.

Packet-based Radio Modems

XCite Radio Modems are packet based. This means all data shifted into one modem is packetized and sent out the antenna port. Because XCite modems use a peer-to-peer architecture, all modems on the same channel (ATHP) will receive the packet and decide whether to pass it to the host or to throw it away. Each transmitted packet contains information about the transmitting modem.

Any modem that receives a packet will check the address values and decide what to do with the packet. The options are as follows:

- Receive the packet as a global packet
- Receive the packet as a local packet
- Discard the packet

Address Mask

The mask parameter can be used to allow a base modem to receive data from a range of addresses. It may also be used to configure "subnets" of modems that communicate in a group together.

Refer to the "Bit-wise AND Truth" table for the Pseudo 'C' Code that qualifies the Destination Addresses and address masks.

The Pseudo Code uses the bit-wise "AND" operation, "&". This operation is performed bit by bit on each of the 16 bits in the TXDT, RXDT and RXMK parameters.

Table 4-01. Bit-wise AND Truth

Bit-wise AND Operation ("&")		
Operand 1	& Operand 2	= Result
0	0	0
0	1	0
1	0	0
1	1	1

For example: Hexadecimal: 0x03 & 0x09 = 0x01

The Address Mask can be used as an additional method of facilitating communications between modems. The Address Mask can be set to one of 65535 possible values using MK (Address Mask) Command. The default value of the MK Parameter is 0xFFFF.

All transmitted data packets contain the Destination Address of the transmitting modem. When a transmitted packet is received by a modem, the Destination Address of the transmitter (contained in the packet) is logically "ANDed" (bitwise) with the Address Mask of the Receiver. If the resulting value matches the Destination Address of the Receiver, or if it matches the Receiver Address Mask, the packet is accepted. Otherwise, the packet is discarded.

Note:When performing this comparison, any "0" values in the Receiver Address Mask are treated as irrelevant and are ignored.

Appendix A: Agency Certifications

FCC (United States) Certification

The XCite OEM RF Module complies with Part 15 of the FCC rules and regulations. Compliance with the labeling requirements, FCC notices and antenna usage guidelines is required.

In order to operate under MaxStream's FCC Certification, OEMs/integrators must comply with the following regulations:

1. The OEM/integrator must ensure that the text provided with this device [Figure A-01] is placed on the outside of the final product and within the final product operation manual.
2. The XCite OEM RF Module may only be used with antennas that have been tested and approved for use with this module [refer to 'FCC-approved Antennas' section].

Labeling Requirements



WARNING: The Original Equipment Manufacturer (OEM) must ensure that FCC labeling requirements are met. This includes a clearly visible label on the outside of the final product enclosure that displays the text shown in the figure below.

Figure A-01. Required FCC Label for OEM products containing the XCite OEM RF Module

Contains FCC ID: OUR-9XCITE

The enclosed device complies with Part 15 of the FCC Rules. Operation is subject to the following two conditions: (i.) this device may not cause harmful interference and (ii.) this device must accept any interference received, including interference that may cause undesired operation.

FCC Notices

IMPORTANT: The XCite OEM RF Module has been certified by the FCC for use with other products without any further certification (as per FCC section 2.1091). Modifications not expressly approved by MaxStream could void the user's authority to operate the equipment.

IMPORTANT: OEMs must test final product to comply with unintentional radiators (FCC section 15.107 & 15.109) before declaring compliance of their final product to Part 15 of the FCC Rules.

IMPORTANT: The RF module has been certified for remote and base radio applications. If the module will be used for portable applications, the device must undergo SAR testing.

This equipment has been tested and found to comply with the limits for a Class B digital device, pursuant to Part 15 of the FCC Rules. These limits are designed to provide reasonable protection against harmful interference in a residential installation. This equipment generates, uses and can radiate radio frequency energy and, if not installed and used in accordance with the instructions, may cause harmful interference to radio communications. However, there is no guarantee that interference will not occur in a particular installation.

If this equipment does cause harmful interference to radio or television reception, which can be determined by turning the equipment off and on, the user is encouraged to try to correct the interference by one or more of the following measures: Re-orient or relocate the receiving antenna, Increase the separation between the equipment and receiver, Connect equipment and receiver to outlets on different circuits, or Consult the dealer or an experienced radio/TV technician for help.

Limited Modular Approval

Power output is conducted at the antenna terminal and can be adjusted from 1 mill-watt to 1 Watt at the OEM level. This is an RF module approved for Limited Modular use operating as a mobile transmitting device with respect to section 2.1091 and is limited to OEM installation for Mobile and Fixed applications only. During final installation, end-users are prohibited from access to any programming parameters. Professional installation adjustment is required for setting module power and antenna gain to meet EIRP compliance for high gain antenna(s).

Final antenna installation and operating configurations of this transmitter including antenna gain and cable loss must not exceed the EIRP of the configuration used for calculating MPE. Grantee (MaxStream) must coordinate with OEM integrators to ensure the end-users and installers of products operating with the module are provided with operating instructions to satisfy RF exposure requirements.

The FCC grant is valid only when the device is sold to OEM integrators. Integrators are instructed to ensure the end-user has no manual instructions to remove, adjust or install the device.

FCC-approved Antennas



WARNING: This device has been tested with Reverse Polarity SMA connectors with the antennas listed in the tables of this section. When integrated into OEM products, fixed antennas require installation preventing end-users from replacing them with non-approved antennas. Antennas not listed in the tables must be tested to comply with FCC Section 15.203 (unique antenna connectors) and Section 15.247 (emissions).

Fixed Base Station and Mobile Applications

MaxStream RF Modules are pre-FCC approved for use in fixed base station and mobile applications. When the antenna is mounted at least 20cm (8") from nearby persons, the application is considered a mobile application.

Portable Applications and SAR Testing

When the antenna is mounted closer than 20cm to nearby persons, then the application is considered "portable" and requires an additional test be performed on the final product. This test is called Specific Absorption Rate (SAR) testing and measures the emissions from the module and how they affect the person.

RF Exposure

This statement must be included as a CAUTION statement in OEM product manuals.



WARNING: This equipment is approved only for mobile and base station transmitting devices. Antenna(s) used for this transmitter must be installed to provide a separation distance of at least 30 cm from all persons and must not be co-located or operating in conjunction with any other antenna or transmitter.

NOTE: The separation distance indicated in the above is 30 cm, but any distance greater than or equal to 23 cm can be used (per MPE evaluation).

Antenna Options (1-watt transmit power output or lower)**Table A-01. Antennas approved for use with the 9XCite (900 MHz) OEM RF Module**

Part Number	Type	Gain	Application
*	Yagi	6.2dBi	Fixed/Mobile **
*	Yagi	7.2dBi	Fixed/Mobile **
A09-Y8	Yagi	8.2dBi	Fixed/Mobile **
	Yagi	9.2dBi	Fixed/Mobile **
	Yagi	10.2dBi	Fixed/Mobile **
A09-Y11	Yagi	11.2dBi	Fixed/Mobile **
	Yagi	12.2dBi	Fixed/Mobile **
	Yagi	13.2dBi	Fixed/Mobile **
	Yagi	14.2dBi	Fixed/Mobile **
A09-Y15	Yagi	15.2dBi	Fixed/Mobile **
A09-F2	Omni Direct	2.2dBi	Fixed **
A09-F5	Omni Direct	5.2dBi	Fixed **
A09-F8	Omni Direct	8.2dBi	Fixed **
*	Omni Direct	9.2dBi	Fixed **
*	Omni Direct	7.2dBi	Fixed **
A09-M7	Omni Direct	7.2dBi	Fixed **
A09-H	1/2 wave antenna	2.1dBi	Fixed/Mobile **
A09-HBMM-P5I	1/2 wave antenna	2.1dBi	Fixed/Mobile **
A09-QBMM-P5I	1/4 wave antenna	1.9 dBi	Fixed/Mobile **
*	1/4 wave integrated wire antenna	1.9 dBi	Fixed/Mobile **

* FCC-approved antennas not inventoried by MaxStream - Contact MaxStream for more information.

** Can be approved for portable applications if integrator gains approval through SAR testing

Over 100 additional antennas that have been tested and are approved for use with MaxStream 900 MHz Radio Modems (including "Mag Mount", "Dome", "Multi-path" and "Panel" antennas).

Because of the large number of approved antennas, MaxStream requests that you send specific information about an antenna you would like to use with the modem and MaxStream will evaluate whether the antenna is covered under our FCC filing.

Contact MaxStream (801) 765-9885 for more information.

IC (Industry Canada) Certification

Labeling Requirements

Labeling requirements for Industry Canada are similar to those of the FCC. A clearly visible label on the outside of the final product enclosure must display the following text:

Contains Model 9XCite Radio (900 MHz), IC: 4214A-9XCITE

Integrator is responsible for its product to comply with IC ICES-003 & FCC Part 15, Sub. B - Unintentional Radiators. ICES-003 is the same as FCC Part 15 Sub. B and Industry Canada accepts FCC test report or CISPR 22 test report for compliance with ICES-003.

Appendix B: Additional Information

1-Year Warranty

XCite RF Modules from MaxStream, Inc. (the "Product") are warranted against defects in materials and workmanship under normal use, for a period of 1-year from the date of purchase. In the event of a product failure due to materials or workmanship, MaxStream will repair or replace the defective product. For warranty service, return the defective product to MaxStream, shipping prepaid, for prompt repair or replacement.

The foregoing sets forth the full extent of MaxStream's warranties regarding the Product. Repair or replacement at MaxStream's option is the exclusive remedy. THIS WARRANTY IS GIVEN IN LIEU OF ALL OTHER WARRANTIES, EXPRESS OR IMPLIED, AND MAXSTREAM SPECIFICALLY DISCLAIMS ALL WARRANTIES OF MERCHANTABILITY OR FITNESS FOR A PARTICULAR PURPOSE. IN NO EVENT SHALL MAXSTREAM, ITS SUPPLIERS OR LICENSORS BE LIABLE FOR DAMAGES IN EXCESS OF THE PURCHASE PRICE OF THE PRODUCT, FOR ANY LOSS OF USE, LOSS OF TIME, INCONVENIENCE, COMMERCIAL LOSS, LOST PROFITS OR SAVINGS, OR OTHER INCIDENTAL, SPECIAL OR CONSEQUENTIAL DAMAGES ARISING OUT OF THE USE OR INABILITY TO USE THE PRODUCT, TO THE FULL EXTENT SUCH MAY BE DISCLAIMED BY LAW. SOME STATES DO NOT ALLOW THE EXCLUSION OR LIMITATION OF INCIDENTAL OR CONSEQUENTIAL DAMAGES. THEREFORE, THE FOREGOING EXCLUSIONS MAY NOT APPLY IN ALL CASES. This warranty provides specific legal rights. Other rights which vary from state to state may also apply.

Ordering Information

Figure B-01. Divisions of the XCite RF Module Part Numbers

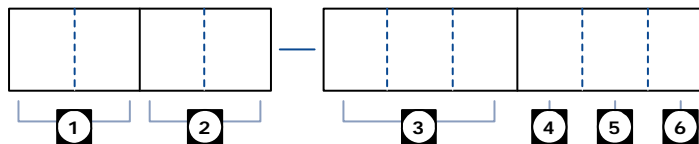

Divisions of the MaxStream OEM RF Module Part Number:

- | | |
|---|---|
| <p>1 MaxStream Product Family
 XC = XCite
 X = XStream
 XT = XTend</p> <p>2 Operating Frequency
 09 = 902-928 MHz
 24 = 2.4000 - 2.4835 GHz
 (XStream only)
 H9 = 923 MHz (XStream/XTend only)</p> <p>3 Throughput Data Rate
 001 = 1200 bps (XStream only)
 009 = 9600 bps
 019 = 19200 bps (XStream only)
 038 = 38400 bps (XCite Only)
 (blank) = All XTend RF Modems support 9600 & 115200 bps (software selectable)</p> | <p>4 Whip Antenna
 W = Integrated Whip Antenna
 N = No whip antenna</p> <p>5 Antenna Connector
 S = RPSMA Connector
 M = MMCX
 N = No connector (wire antenna)</p> <p>6 Temperature Rating
 C = Commercial: 0 to 70° C
 I = Industrial: -40 to 85° C, conformal coated
 T = Tested: -40 to 85° C, conformal coating, 100% tested</p> |
|---|---|

Contact MaxStream

Free and unlimited technical support is included with every MaxStream Radio Modem sold. For the best in wireless data solutions and support, please use the following resources:

Documentation:	www.maxstream.net/support/downloads.php	
Technical Support:	Phone.	(866) 765-9885 toll-free U.S.A. & Canada (801) 765-9885 Worldwide
	Live Chat.	www.maxstream.net
	E-Mail.	rf-xperts@maxstream.net

MaxStream office hours are 8:00 am - 5:00 pm [U.S. Mountain Standard Time]