

Specification

Part No.	:	MCS6.A
Product Name	:	NB-IoT / CAT M1 Low Profile LTE SMD Dielectric Antenna
Features	:	GSM / CDMA / DCS / PCS / WCDMA / UMTS /HSDPA / GPRS / EDGE NB-IoT / CAT M1 Bands 698~960MHz / 1710~2690MHz High Efficiency Multi-Band SMD antenna Low profile 42*10*3mm RoHs Compliant



1. Introduction

The MCS6.A is a low profile SMD NB-IoT / CAT M1 Bands / 4G/3G/2G embedded antenna designed for direct SMD mount on a device PCB. It provides high efficiency in a very small form factor of just 42*10*3mm.

NB-IoT / CAT M1 is a low power wide area (LPWA) technology specifically designed for IoT and M2M. NB-IoT / CAT M1 technology offers lower maintenance cost, with greater efficiency and reliability by reducing power consumption and providing deeper penetration compared to standard cellular technologies. It operates on secure mobile networks making it suited to automotive, smart meter, medical and smart city applications.

If tuning is required, the MCS6.A can be tuned for the device environment without the need for new tooling. Its rectangular shape and very small size makes it very easy to integrate. It is supplied on tape and reel ensuring that it can be mounted via pick and place to reflow solder directly on the edge of the PCB board.

This antenna is recommended to be used with longer ground-plane lengths of 120mm or more to attain its highest rated efficiency. Note the Return Loss and Efficiency graphs on Page 16.

Contact Taoglas local regional sales office for quick and professional support from our senior engineering team on integration and matching of the antenna to your device.

2. Specification Table

ELECTRICAL						
Frequency(MHz)	Band 2		Band 4		Band 12	
	Tx	Rx	Tx	Rx	Tx	Rx
	1850-1910	1930-1990	1710-1755	2110-2155	699-716	729-746
Peak Gain (dBi)*	2.76	3.26	3.11	3.75	-1.05	-0.02
Average Gain (dBi)*	-2.04	-1.67	-1.65	-1.85	-3.50	-2.25
Efficiency (%)*	62.46	67.47	68.33	65.67	44.58	59.60
Return Loss (dB)*	<-10 typ. <-6 at the band edge		<-10 typ. <-7 at the band edge		<-10 typ. <-5 at the band edge	
Polarization	Linear					
Impedance	50Ω					
Maximum Input Power	5W					
MECHANICAL						
Antenna Dimensions	42mm x 10mm x 3mm					
Material	FR4					
Weight	2.50g					
Soldering Type	SMT through Reflow					
ENVIRONMENTAL						
Operation Temperature	-40°C ~ +85°C					
Storage Temperature	-40°C ~ +85°C					

*All measurements were done on 123*45mm EVB board with 100mm length ground plane.

3. Antenna Characteristics

3.1. Return Loss

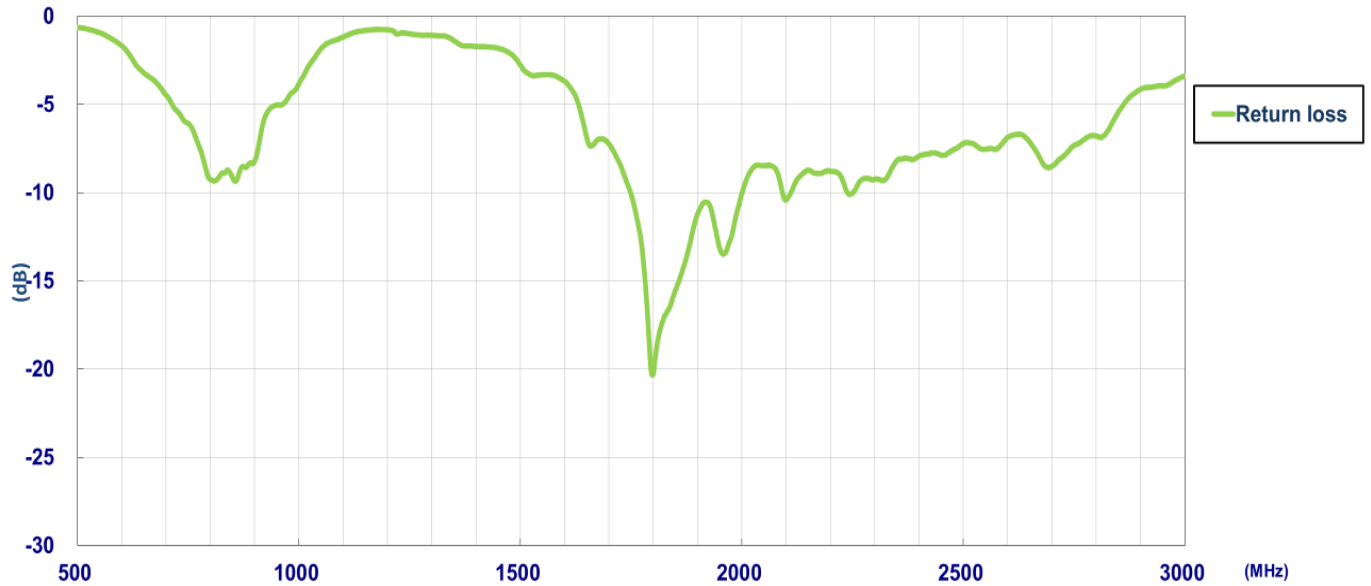

3.2. Peak Gain

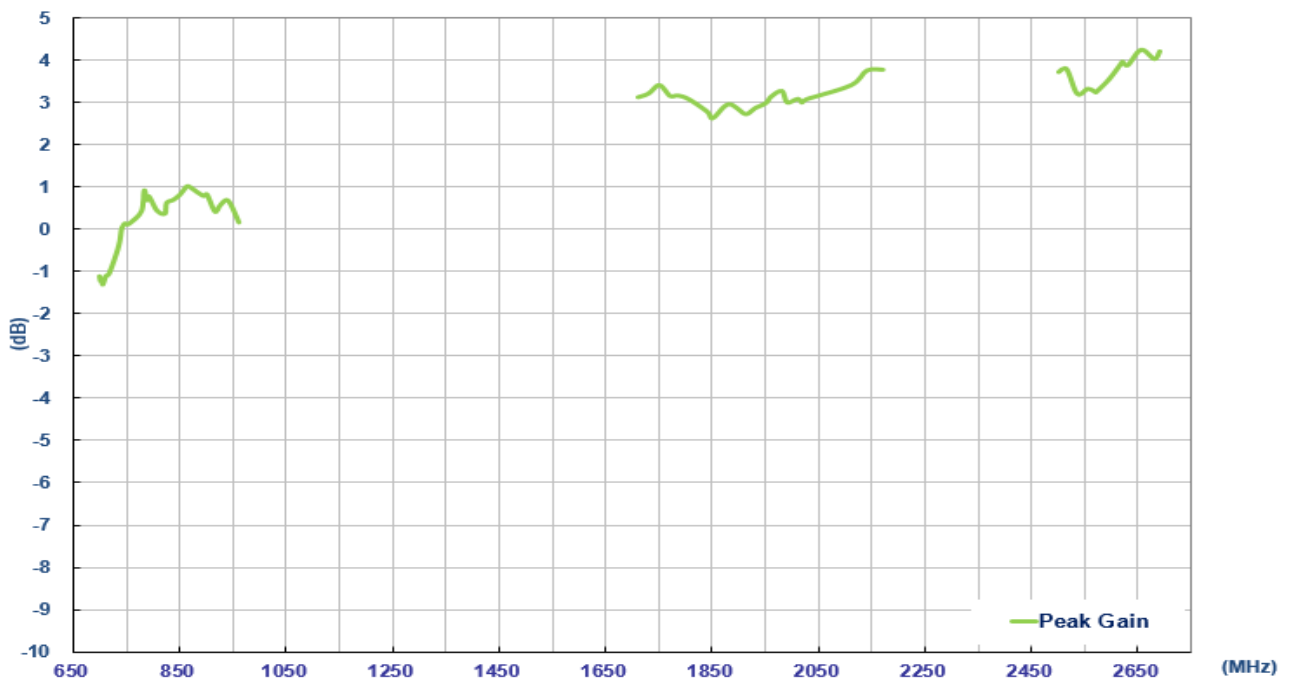

3.3. Average Gain

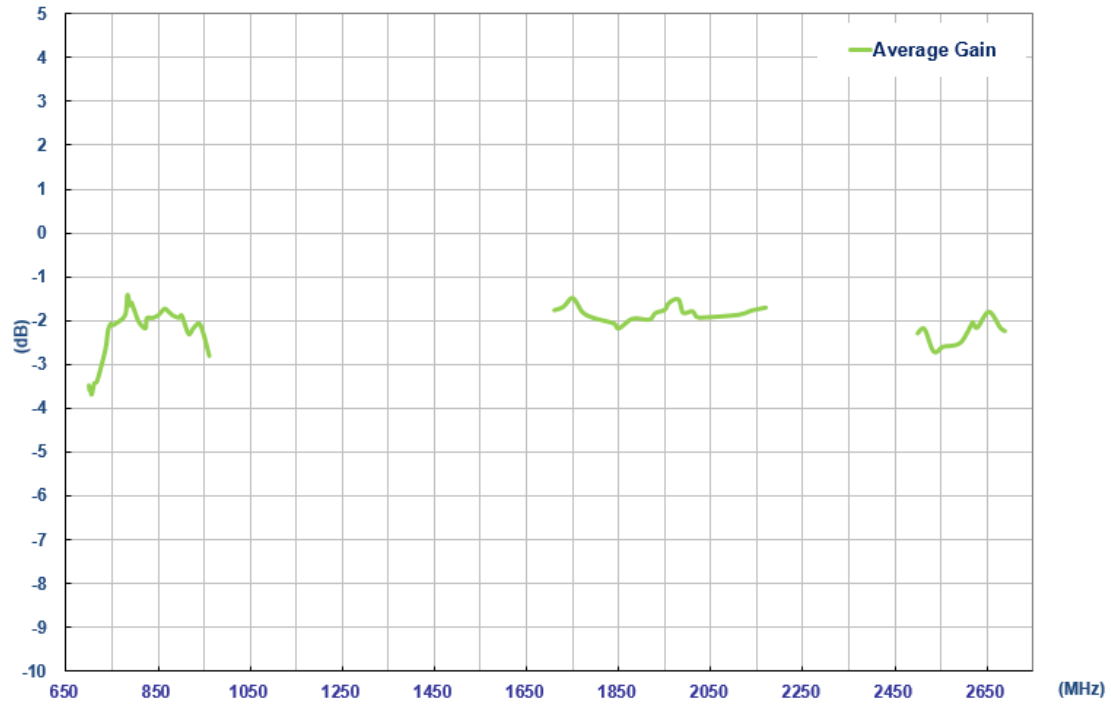

3.4. Efficiency

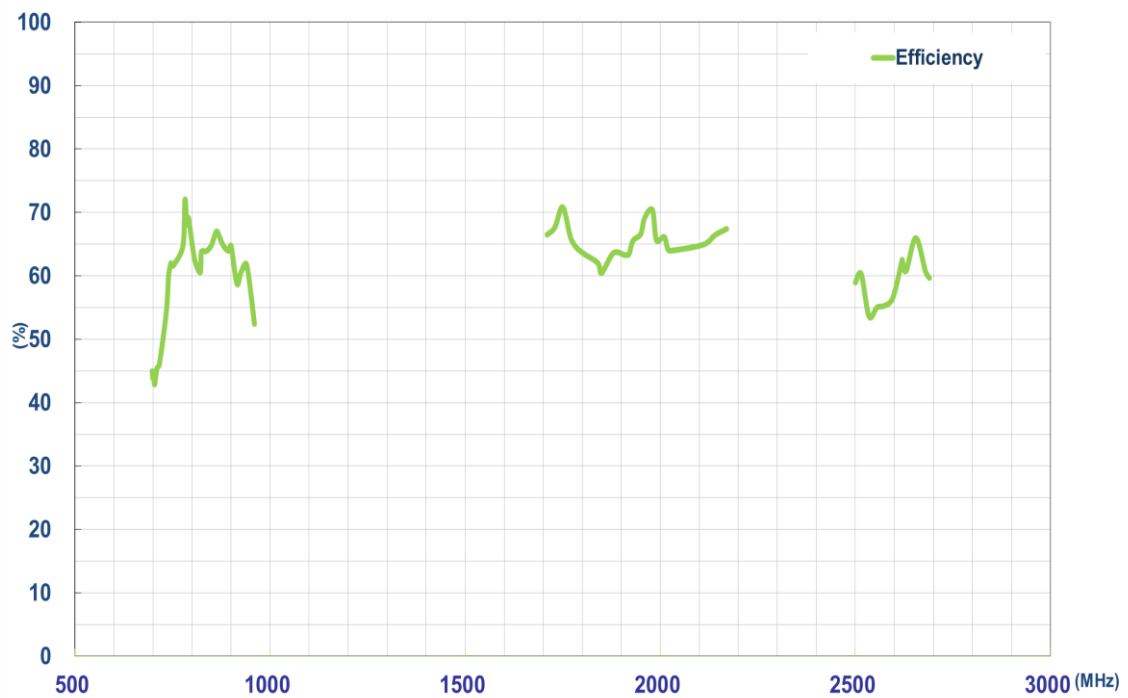

4. Radiation Patterns

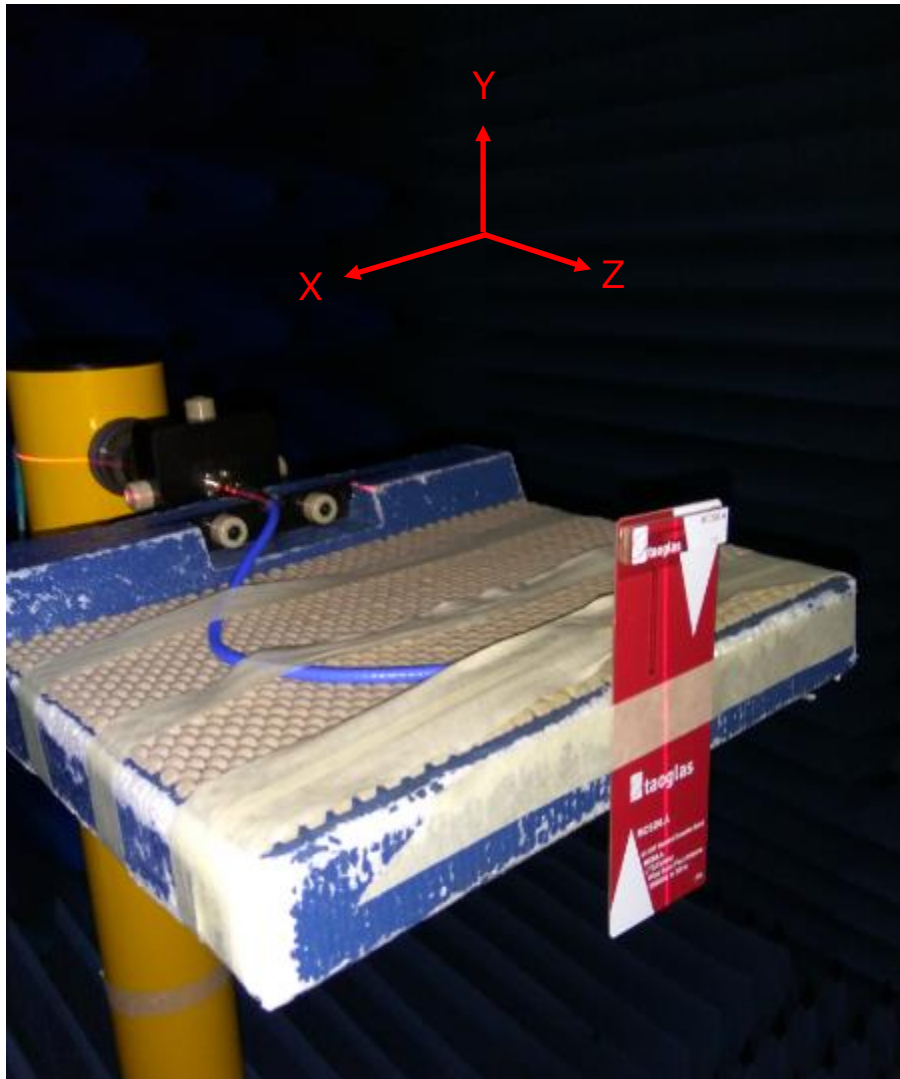

4.1. 2D Radiation Pattern

XY Plane

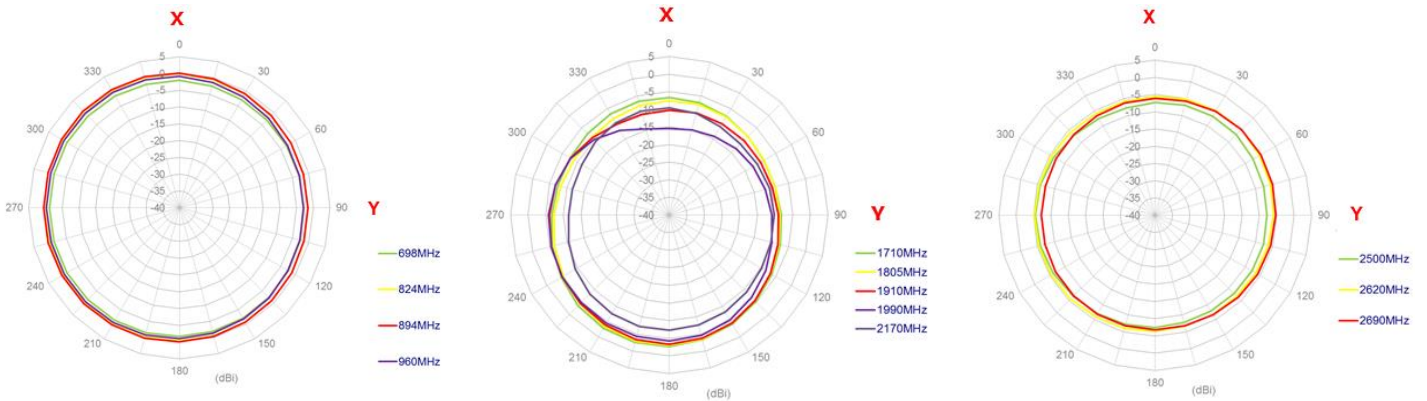

XZ Plane

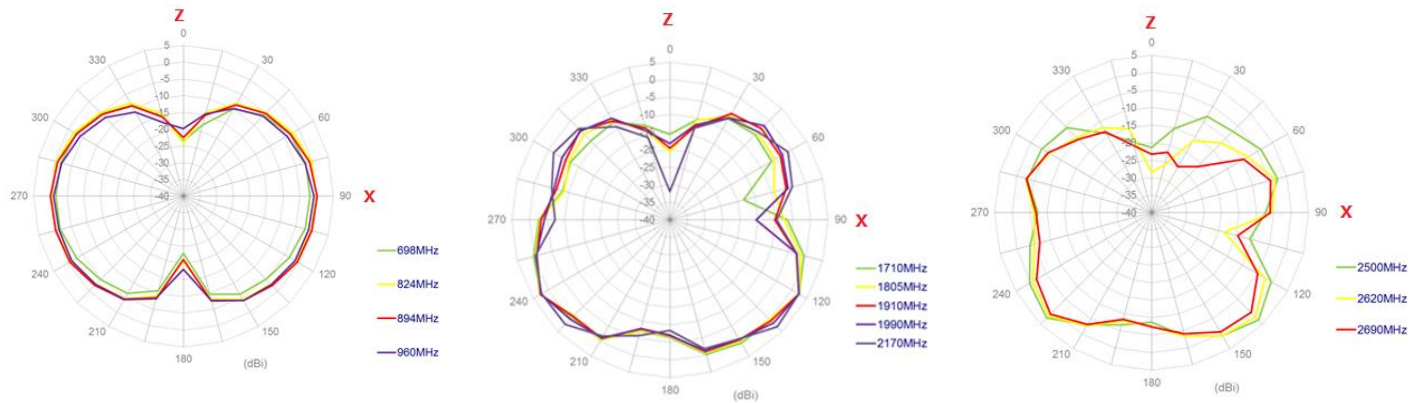

YZ Plane

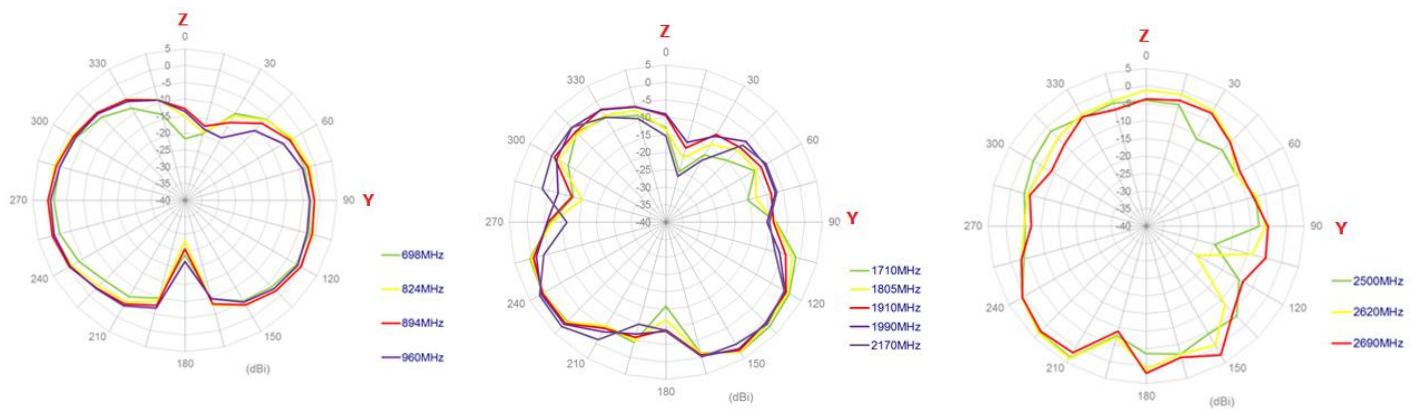

4.2. 3D Radiation Pattern

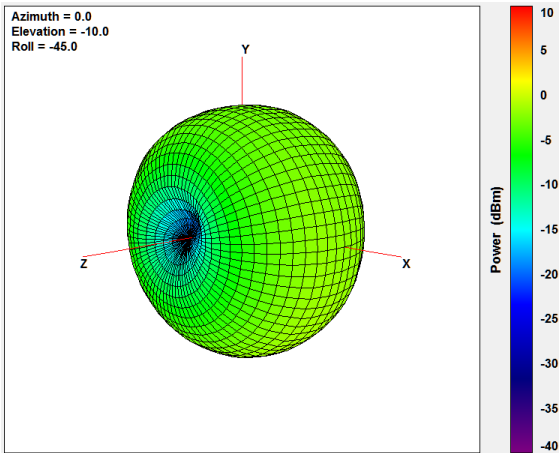

698MHz

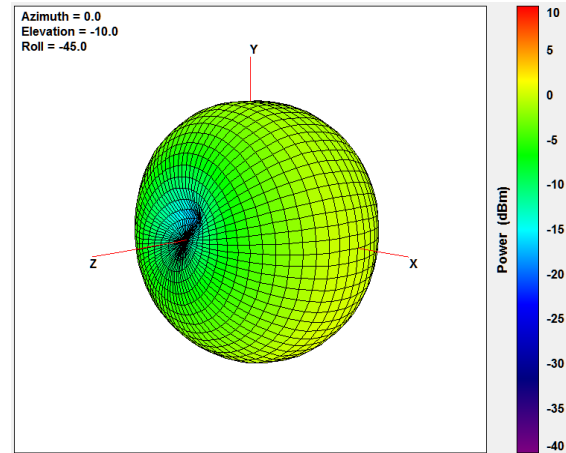

824MHz

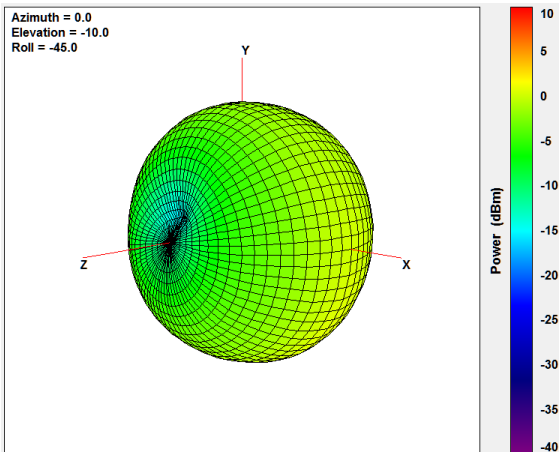

894MHz

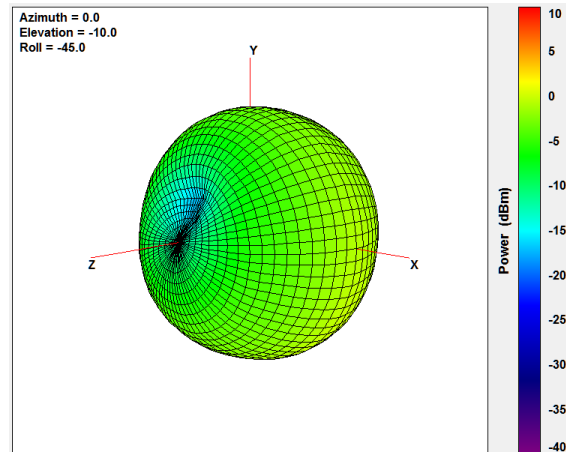

960MHz

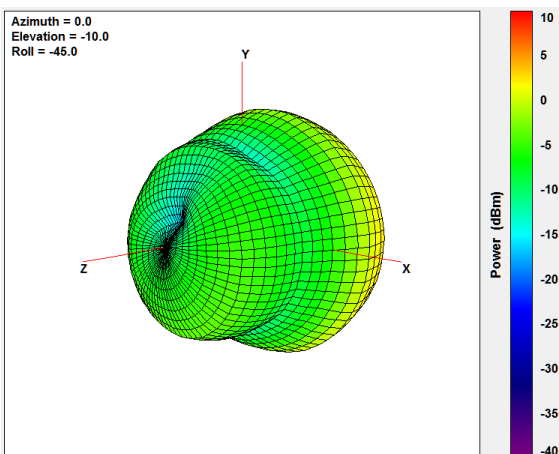

1710MHz

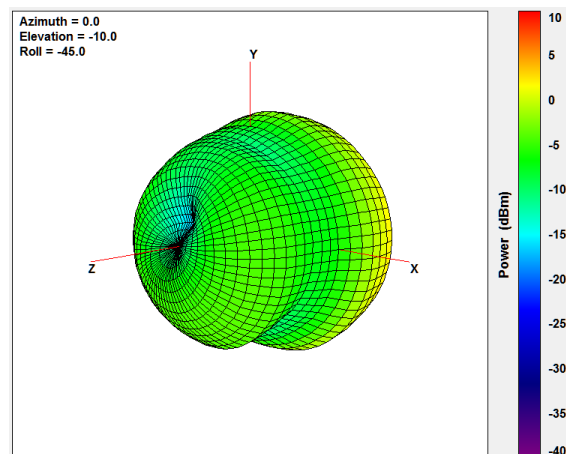

1805MHz

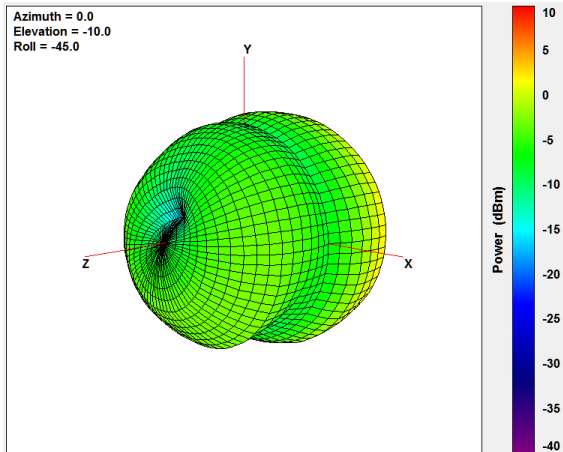

1910MHz

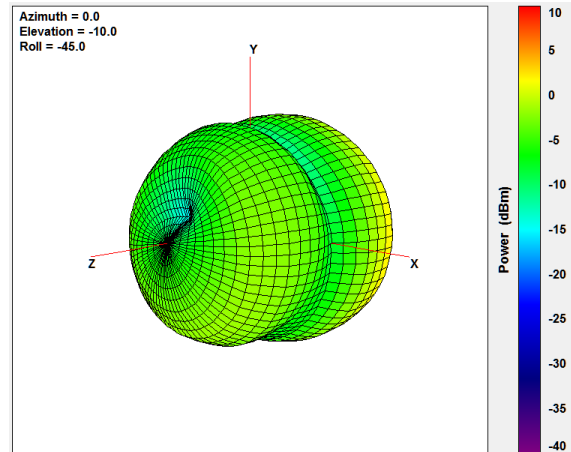

1990MHz

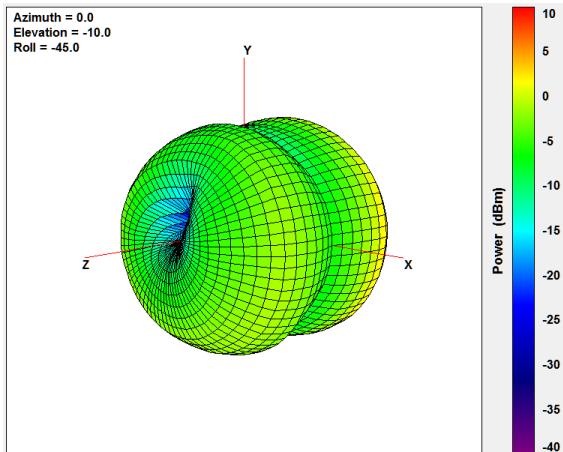

2170MHz

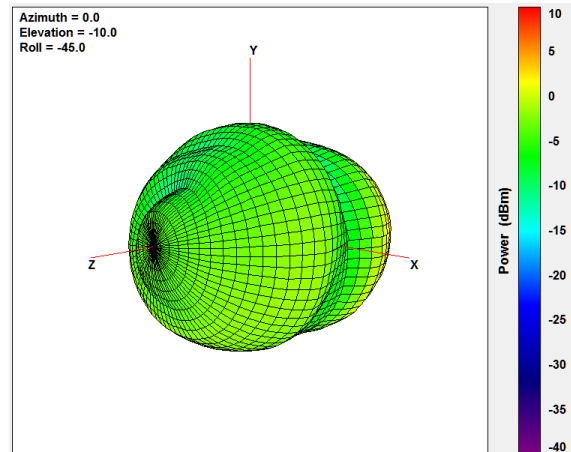

2500MHz

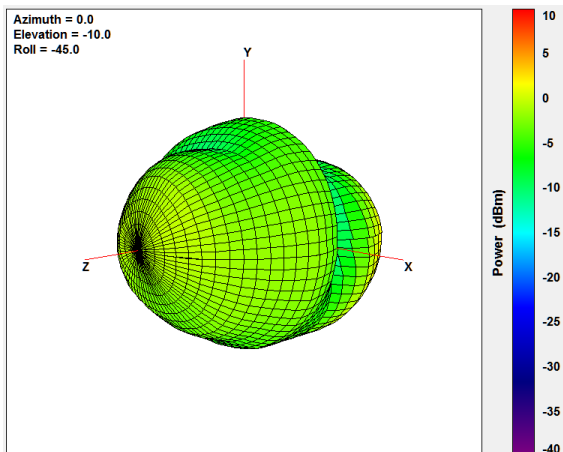

2620MHz

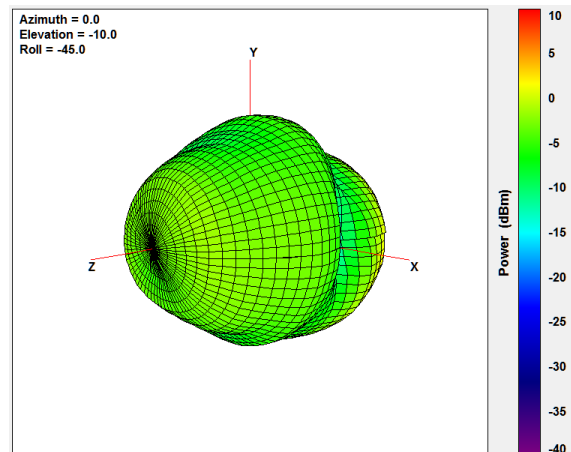

2690MHz



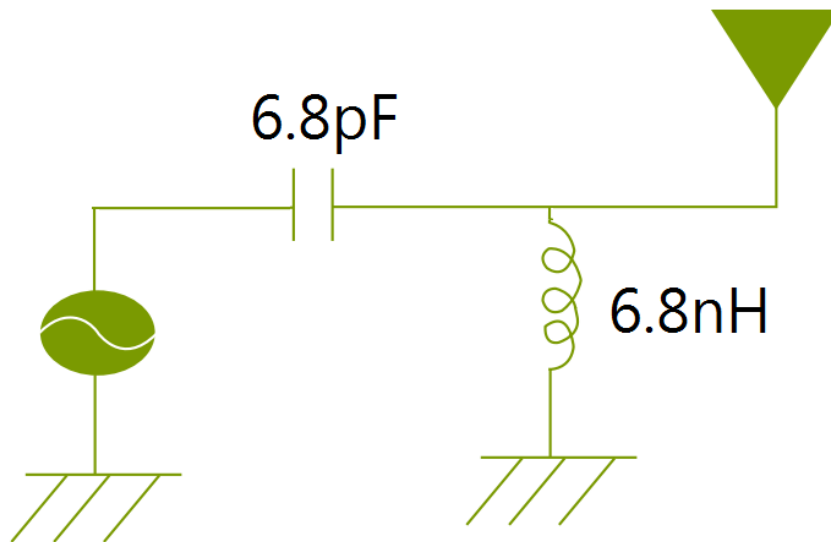



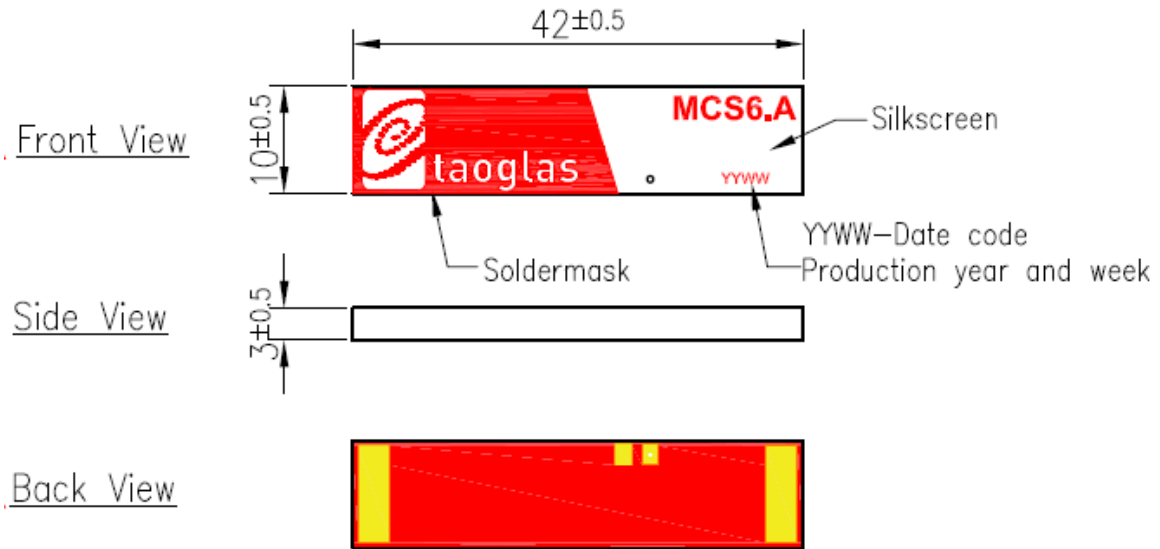



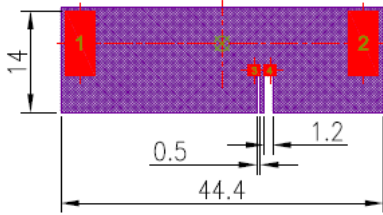
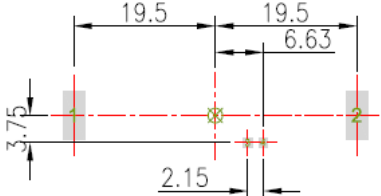
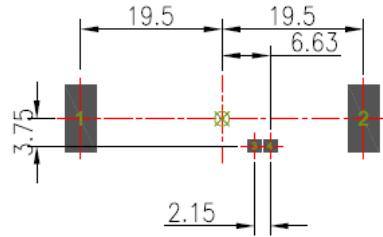
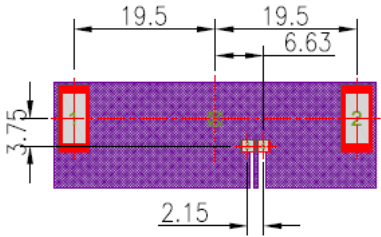





5. Matching Circuits



6. Mechanical Drawing (Unit: mm)



6.1. Antenna Footprint (Unit: mm)

FootPrint												
<p>Top Copper</p> <p>Pads 1 and 2 are the same size, Pads 3 and 4 are the same size, Pad 4 should be connected to a 50 ohm transmission line.</p> 	<p>Top Solder Paste</p> <p>Pads 1 and 2 are the same size, Pads 3 and 4 are the same size.</p> 											
<p>Top Solder Mask</p> 	<p>Composite Diagram</p> 											
<p>NOTE:</p> <table border="0"> <tr> <td>1. Tin Plated area</td> <td></td> <td rowspan="8"> <p>6. Ground keepout should extend through any inner PCB layers and any sides around the antenna till the board edge to minimize coupling from RF feed to ground, except the side facing system ground.</p> <p>7. Any vias in pads should be either filled or tented to prevent solder from wicking away from the pad during reflow.</p> <p>8. The dimension tolerances should follow standard PCB manufacturing guidelines</p> </td> </tr> <tr> <td>2. Solder Mask area</td> <td></td> </tr> <tr> <td>3. Copper area</td> <td></td> </tr> <tr> <td>4. Paste area</td> <td></td> </tr> <tr> <td>5. Keepout Region area</td> <td></td> </tr> </table>		1. Tin Plated area		<p>6. Ground keepout should extend through any inner PCB layers and any sides around the antenna till the board edge to minimize coupling from RF feed to ground, except the side facing system ground.</p> <p>7. Any vias in pads should be either filled or tented to prevent solder from wicking away from the pad during reflow.</p> <p>8. The dimension tolerances should follow standard PCB manufacturing guidelines</p>	2. Solder Mask area		3. Copper area		4. Paste area		5. Keepout Region area	
1. Tin Plated area		<p>6. Ground keepout should extend through any inner PCB layers and any sides around the antenna till the board edge to minimize coupling from RF feed to ground, except the side facing system ground.</p> <p>7. Any vias in pads should be either filled or tented to prevent solder from wicking away from the pad during reflow.</p> <p>8. The dimension tolerances should follow standard PCB manufacturing guidelines</p>										
2. Solder Mask area												
3. Copper area												
4. Paste area												
5. Keepout Region area												

6.2. Evaluation Board

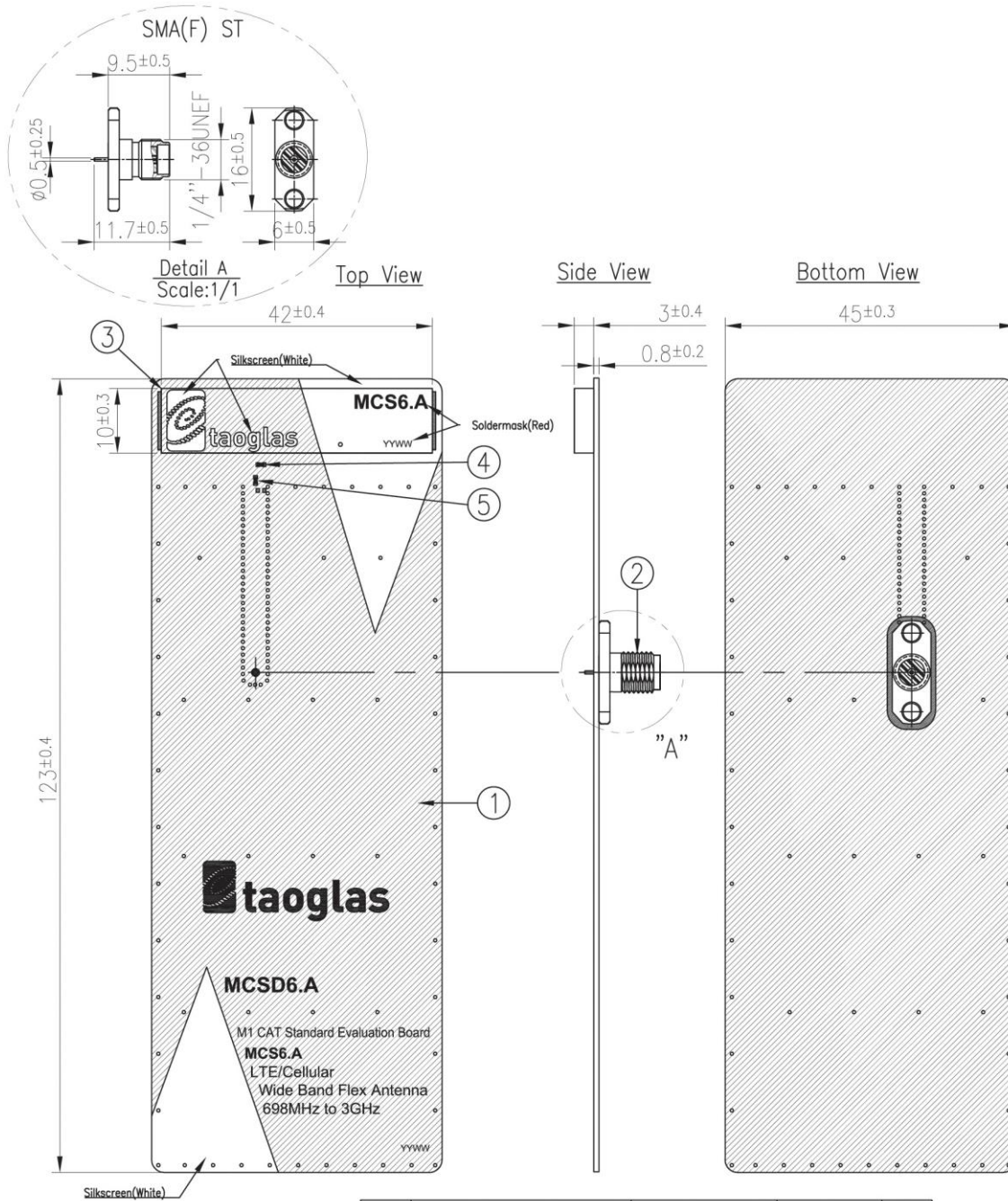

	Name	Material	Finish	QTY
1	MCS6.A EVB PCB	Composite .08t	Red	1
2	SMA(F) ST PCB	Brass	Au Plated	1
3	MCS6.A PCB Antenna	Composite 3t	Red	1
4	6.8nH Inductor (0402)	Ceramic	N/A	1
5	6.8pF Capacitor (0402)	Ceramic	N/A	1

7. Packaging

1000 pc MCS6.A per reel
Dimensions - Ø330*60mm
Weight - 2Kg

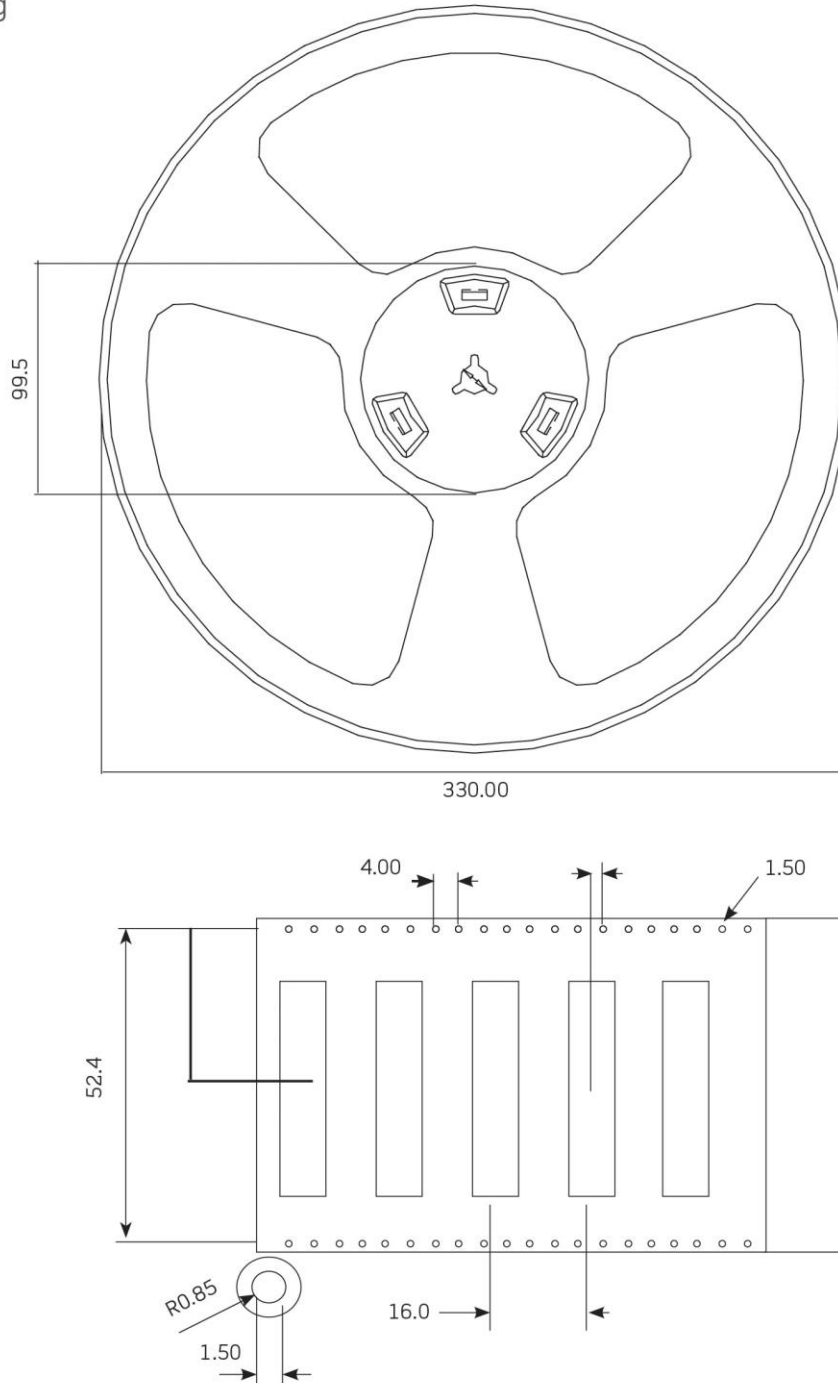

1000 pcs MCS6.A reel
Dimensions - 330*330*60mm
Weight - 2kg

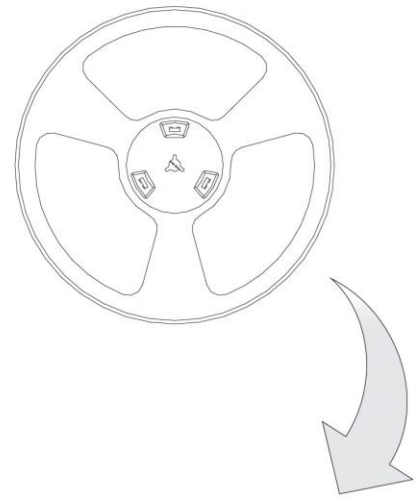

1000 pcs MCS6.A / 1 Reel in small box
Dimensions - 335*340*90mm
Weight - 2.1Kg

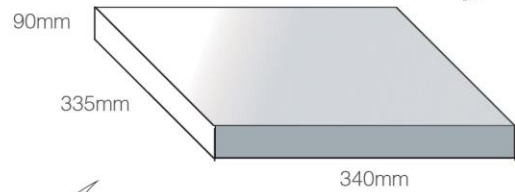

4 reels, 4000 pcs in one carton
Carton Dimensions - 370*360*370mm
Weight - 9.2Kg

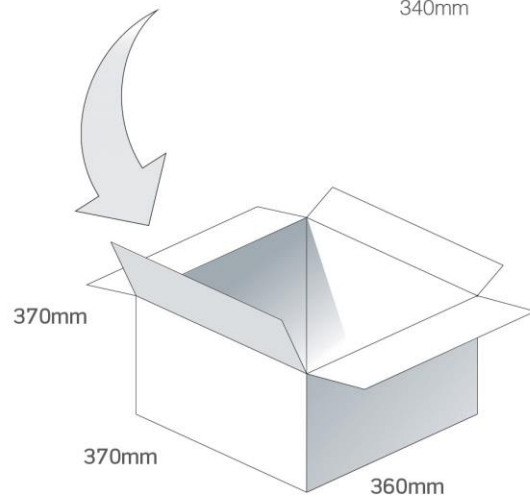

Pallet Dimensions 1200*1000*1310mm
18 Cartons per Pallet
6 Cartons per layer
3 Layers

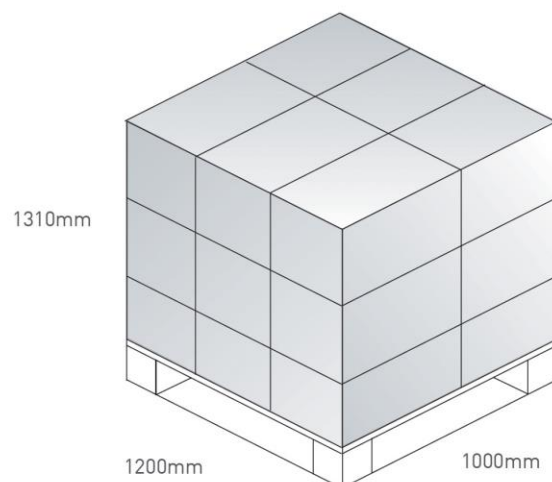

8. Application Note

Investigations of MCS6.A antenna performance on different lengths of ground plane were conducted.

8.1. Return Loss

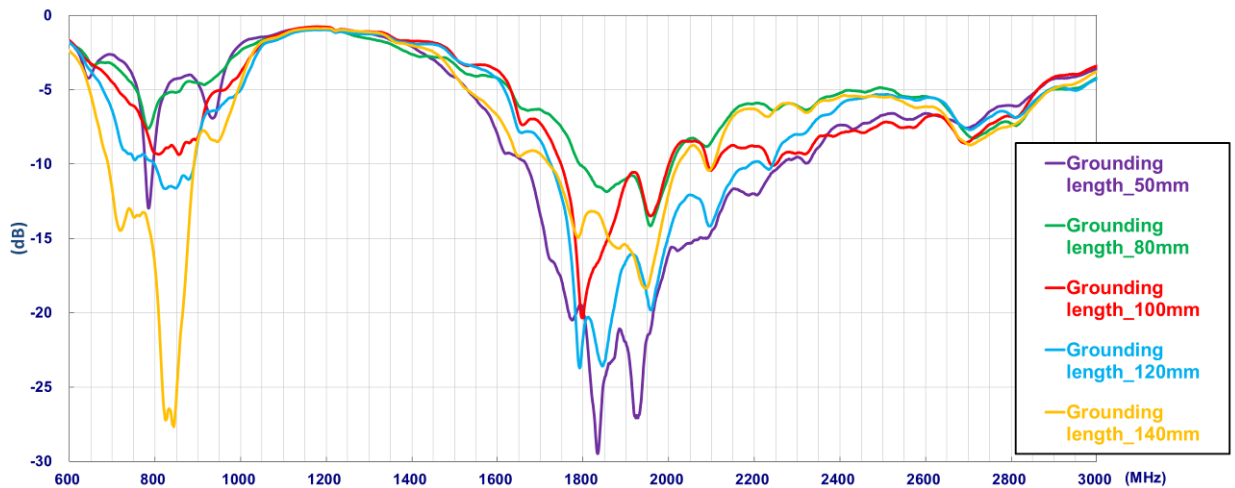

The antenna efficiency vs. ground plane length is shown below.

8.2. Efficiency

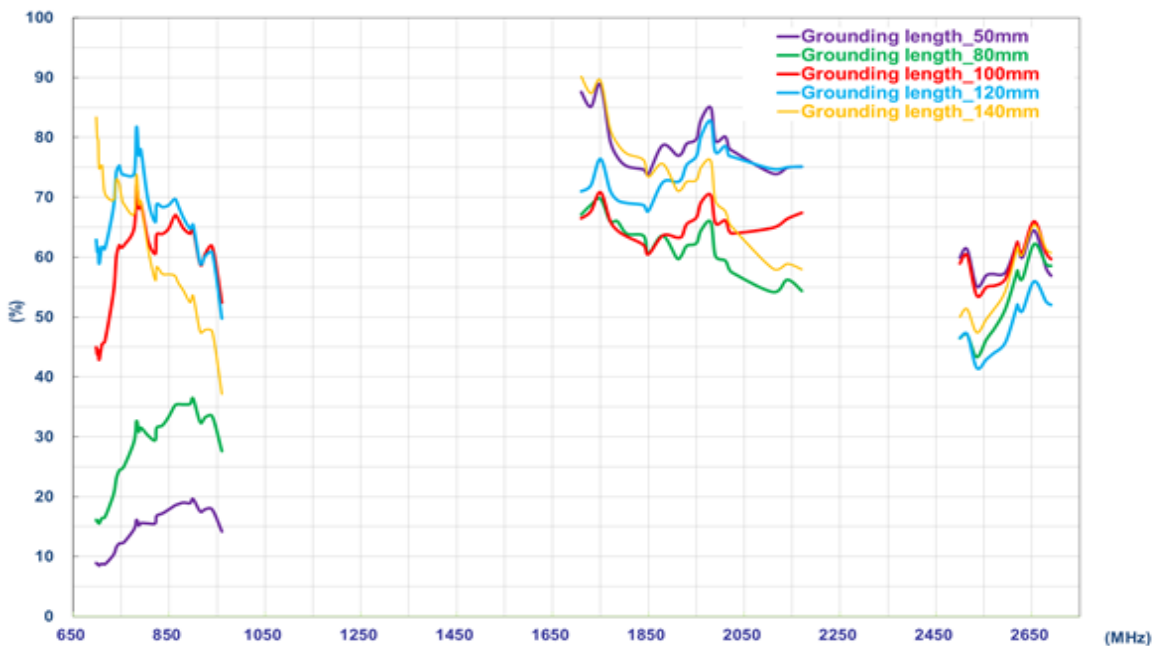

8.3. Peak Gain

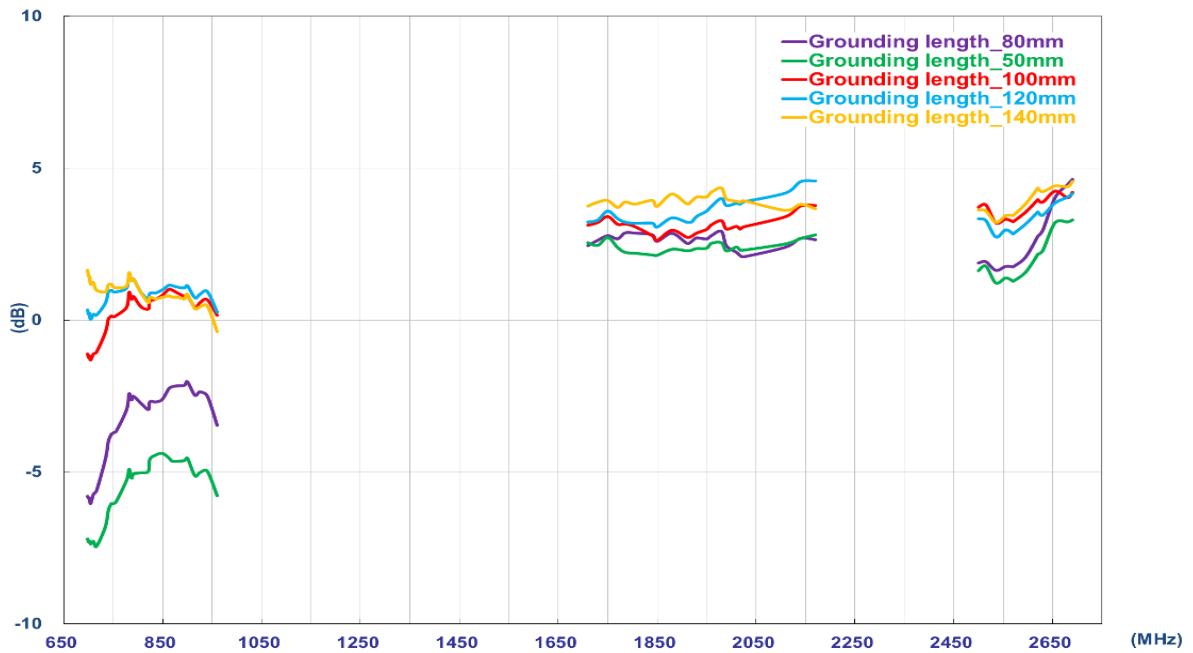

8.4. Average Gain

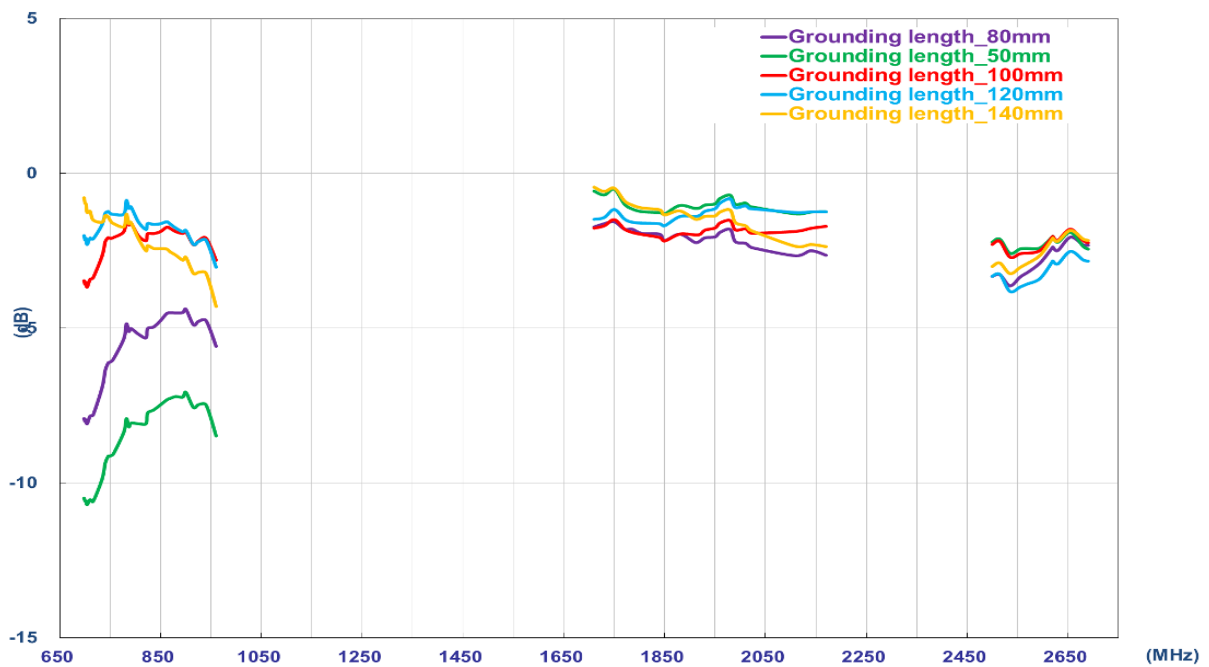

Taoglas makes no warranties based on the accuracy or completeness of the contents of this document and reserves the right to make changes to specifications and product descriptions at any time without notice. Taoglas reserves all rights to this document and the information contained herein.

Reproduction, use or disclosure to third parties without express permission is strictly prohibited.

Copyright © Taoglas Ltd.