

FB-EM-30345-000
SHT 1.1

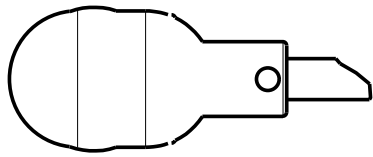

TOP VIEW
W/WINDSHIELD SHOWN
SCALE 1:1

$\varnothing 19,0 \pm 0,3$
[.748 ± .012]

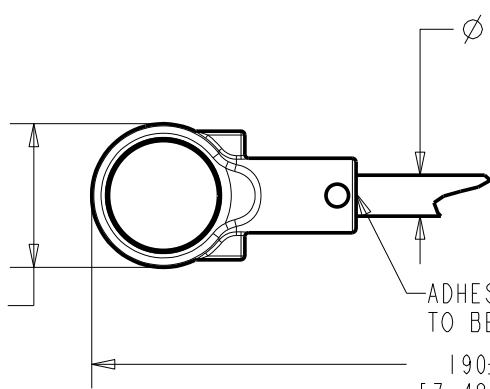

$\varnothing 5,41_{-0,20}^0$
[.213^{+.000}_{-.008}]

ADHESIVE BUILD UP
TO BE 2mm MAX.

190 ± 10
[7.48 ± .39]

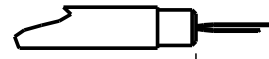

60 ± 5
[2.36 ± .20]

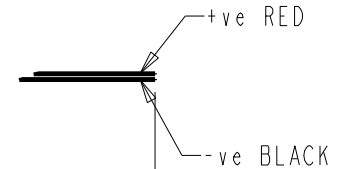

+ve RED

-ve BLACK

PLASTIC HOUSING, BLACK

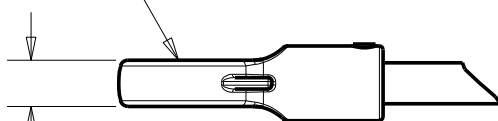

$6,10 \pm 0,12$
[.240 ± .005]

BLACK POLYURETHANE SHRINK COVER
ON FLEXI-SET BOOM

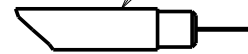

WIRES

2mm STRIPPED & TINNED ENDS

WIRE COLOR			WEIGHT GRAMS
+ve	OUTPUT	-ve	
RED	---	BLACK	---

DIMENSIONS IN MILLIMETERS [INCHES]

Revision	C.O. #	Implementation Date	RELEASE LEVEL	REVISION
B	C10107747	8-9-08	Active	B
A	C10107368	5-27-08		

SCALE:

1:1

DO NOT SCALE DRAWING

TITLE:

BOOM MICROPHONE FB-EM-30345-000

OUTLINE DRAWING

SHT 1.1

DR. BY	DATE
TT	5-27-08
CK. BY	DATE
GJP	6-4-08
APP. BY	DATE
GJP	6-4-08

KNOWLES ELECTRONICS
ITASCA, ILLINOIS U.S.A.

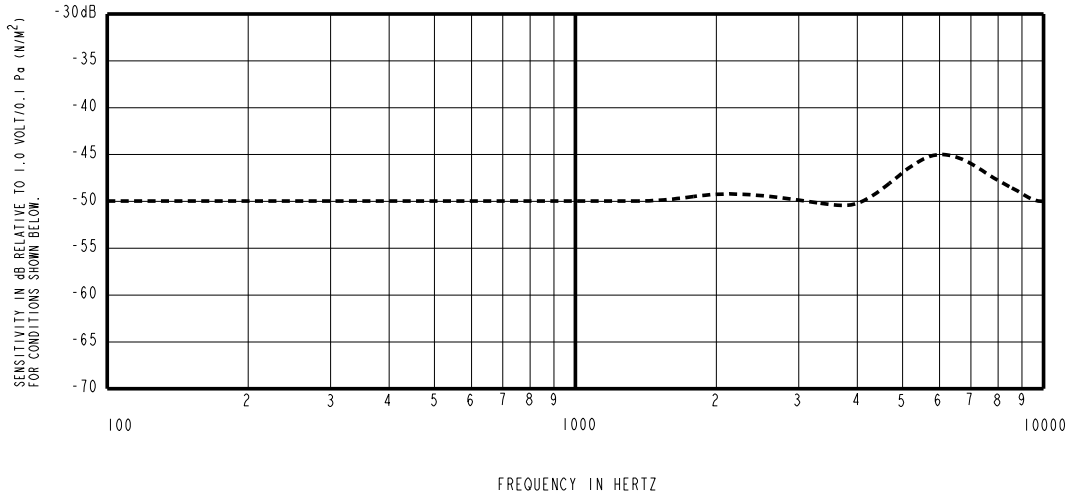

FREQUENCY	SENSITIVITY			DEVICE CONFORMITY	
	MIN.	NOM.	MAX.	RANGE OF DEVIATION FROM 1KHz	
300	---	-50.0	---	-4.0	+4.0
1000	-54.0	-50.0	-46	0.0	0.0
2000	---	-49.5	---	-4.0	---
6000	---	-45.5	---	0.0	+9

NOTES:

- MICROPHONE TO BE FUNCTIONAL WITH 10 VDC SUPPLY.
- SENSITIVITY VALUES INDICATED ON THIS SPECIFICATION ARE VALID AT 50% HUMIDITY.
- TEST CONDITIONS:
HEAD OF BOOM EXPOSED TO 74 dB SPL SWEPT SOUND FIELD AT 6mm FROM VOICE APERTURE, ARTIFICIAL VOICE:
B & k 4227 MOUTH SIMULATOR.
- FOR MICROPHONE CAPSULE SPEC. SEE DRAWING NR-25994-D63 SHEET 2.1.
- SURVIVES SUBMERSION IN 20m OF WATER FOR 5 MINUTES; SENSITIVITY WITHIN 3dB OF INITIAL SENSITIVITY AFTER DRIED FOR 30 MINUTES AT ROOM TEMPERATURE.

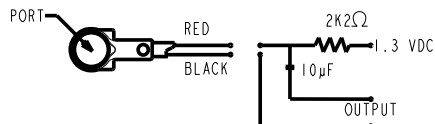
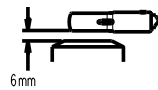

LEAD IDENTIFICATION & TEST CIRCUIT

KNOWLES ELECTRONICS
ITASCA, ILLINOIS U.S.A.

Revision	C.O. #	Implementation Date	RELEASE LEVEL	REVISION
B	C10107747	8-9-08	Active	B
A	C10107368	5-27-08		
WHEN TEST LIMITS ARE USED TO ESTABLISH INCOMING INSPECTION ACCEPTANCE/REJECTION CRITERIA, CORRELATION OF TEST EQUIPMENT WITH KNOWLES IS ALSO REQUIRED FOR ELIMINATION OF EQUIPMENT AND TEST METHOD VARIATION				DR. BY DATE
TITLE: BOOM MICROPHONE FB-EM-30345-000				TT 5-27-08
				CK. BY DATE
PERFORMANCE SPECIFICATION				GJP 6-4-08
				APP. BY DATE
SHT 2.1				GJP 6-4-08