

# UM10491

User manual for the BGU7004 GPS LNA evaluation board

Rev. 1.0 — 14 June 2011

User manual

## Document information

Info	Content
<b>Keywords</b>	LNA, GPS, BGU7004
<b>Abstract</b>	This document explains the BGU7004 AEC-Q100 qualified GPS low noise amplifier evaluation board

**Revision history**

Rev	Date	Description
1.0	20110614	First Release.

**Contact information**

For additional information, please visit: <http://www.nxp.com>

For sales office addresses, please send an email to: [salesaddresses@nxp.com](mailto:salesaddresses@nxp.com)

## 1. Introduction

NXP Semiconductors' BGU7004 is an AEC-Q100 qualified low-noise amplifier for GPS receiver applications in a plastic, leadless 6 pin, extremely thin small outline SOT886 package. It has a gain of 16.5 dB gain and a noise figure of 0.8 dB. It has superior linearity performance to suppress interference and noise from co-habitation cellular transmitters while retaining sensitivity.

The LNA has been designed using NXP Semiconductors' advanced 110 GHz  $f_T$  SiGe:C process. The BGU7004 only requires two external components, one series inductor for input matching and one decoupling capacitor. The BGU7004 contains one RF stage and internal bias that is temperature stabilized. It is also supplied with an enable function allowing it to be controlled by a logic signal.

The BGU7004 is ideal for use as GPS LNA in handsets, PDA's and PND's.

The GPS LNA evaluation board (EVB) see [Fig 1](#), is designed to evaluate the performance of the BGU7004 applied as a GPS LNA. In this document, the application diagram, board layout, bill of materials, and typical results are given, as well as some explanations on

GPS related performance parameters like out-of-band input third-order intercept point, gain compression under jamming and noise under jamming.

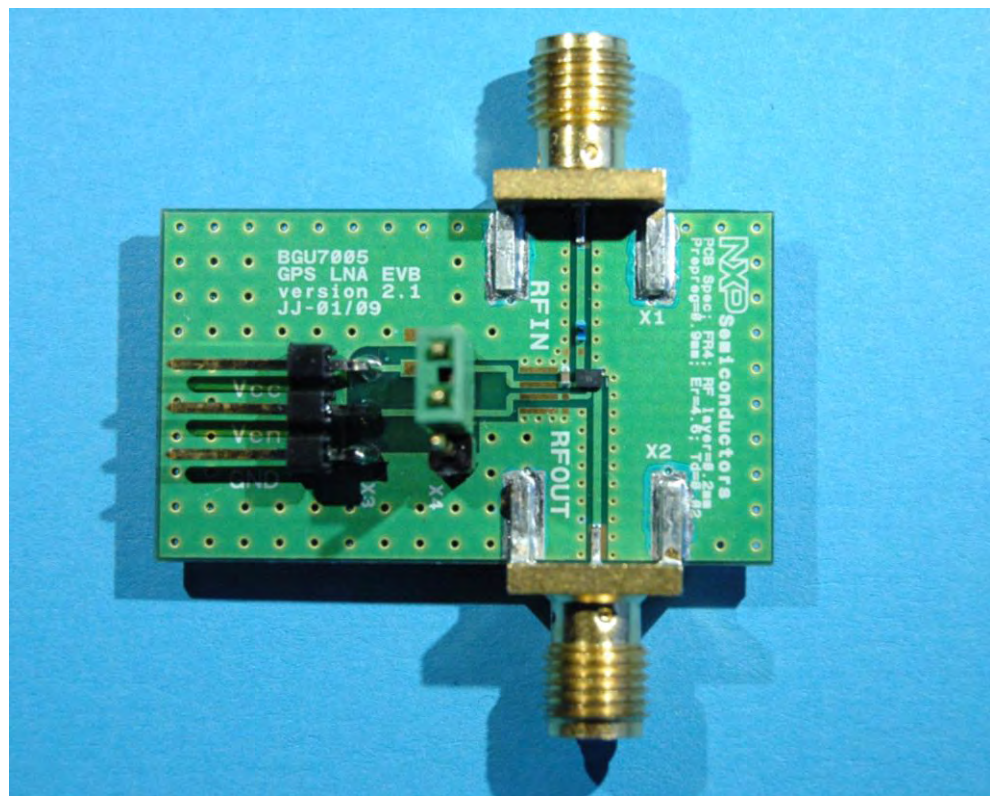

Fig 1. BGU7004 GPS LNA evaluation board

## 2. General description

---

NXP Semiconductors' BGU7004 GPS low noise amplifier is dedicated for the GPS frequency band. The integrated biasing circuit is temperature stabilized, which maintains a constant current over temperature. It also enables the superior linearity performance of the BGU7004. It is also supplied with an enable function that allows it to be controlled with a logic signal. In disabled mode it only consumes less than 1 $\mu$ A.

The output of the BGU7004 is internally matched for 1575.42 MHz whereas only one series inductor at the input is needed to achieve the best RF performance. Both the input and output are AC coupled via an integrated capacitor.

Only two external components are required to build a GPS LNA with the following advantages:

- Low noise;
- High gain;
- High linearity under jamming;
- Very low package height 0.5mm;
- Low current consumption;
- Short power settling time;

The data sheet of the BGU7004 is available, and it is called "SiGe:C Low Noise Amplifier MMIC for GPS applications"

## 3. Application Board

---

The BGU7004 GPS LNA evaluation board simplifies the evaluation of the BGU7004 GPS LNA for the GPS application. The evaluation board enables testing of the device performance and requires no additional support circuitry. The board is fully assembled with the BGU7004, including the input series inductor as well as a decoupling capacitor to optimize the performance. The board is supplied with two SMA connectors for input and output connection to RF test equipment. The BGU7004 can operate from a 1.5V to 2.85V single supply and consumes about 5 mA.

### 3.1 Application Circuit

The circuit diagram of the evaluation board is shown in Fig 2.

With jumper JU1 the enable pin can be controlled to either to  $V_{cc}$  or GND.

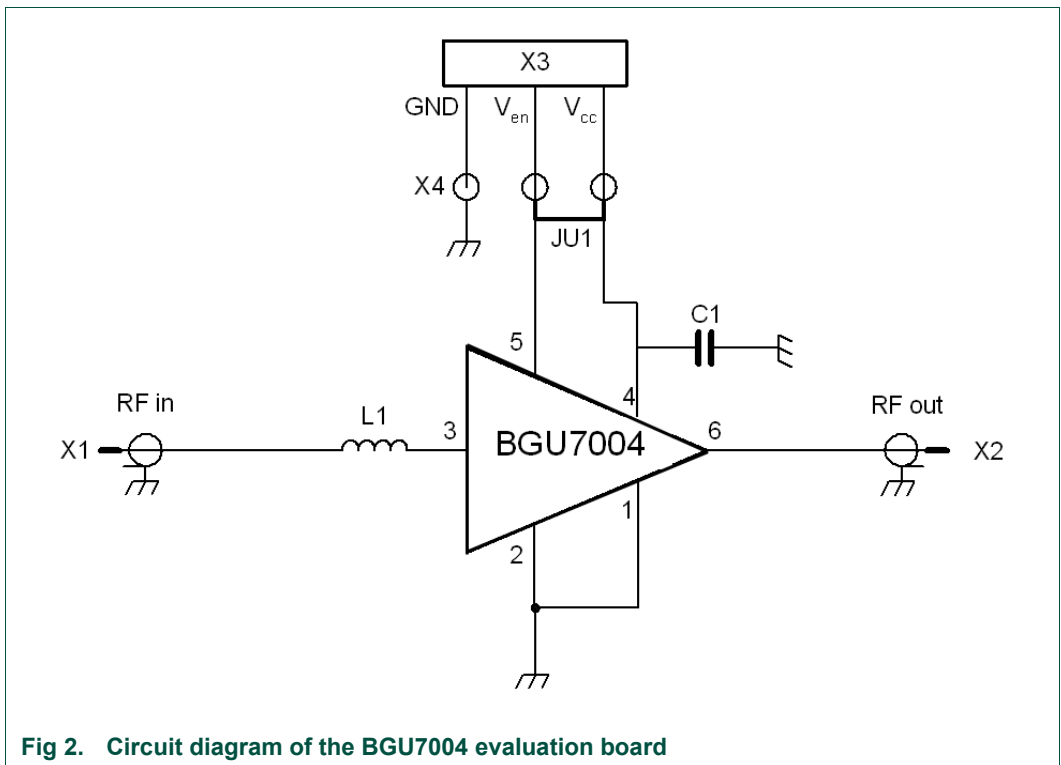

Fig 2. Circuit diagram of the BGU7004 evaluation board

### 3.2 Board Layout

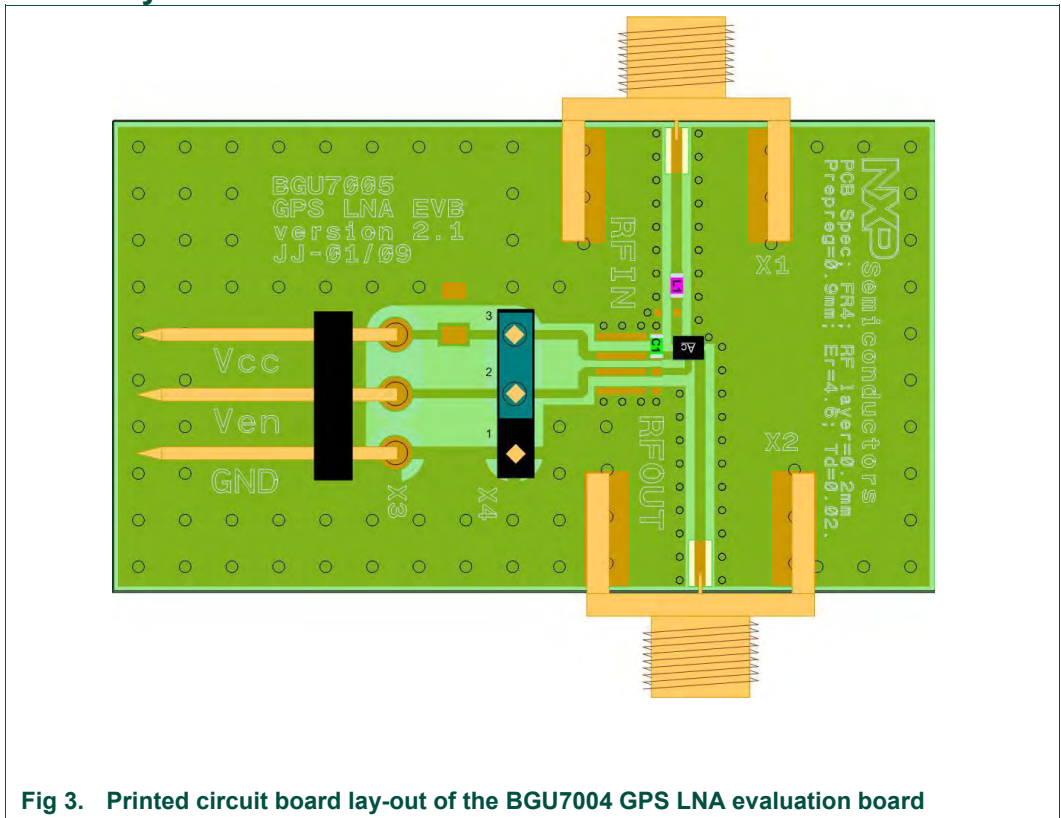

Fig 3. Printed circuit board lay-out of the BGU7004 GPS LNA evaluation board

### 3.3 PCB layout

A good PCB layout is an essential part of an RF circuit design. The evaluation board of the BGU7004 can serve as a guideline for laying out a board using the BGU7004. Use controlled impedance lines for all high frequency inputs and outputs. Bypass  $V_{cc}$  with decoupling capacitors, preferably located as close as possible to the device. For long bias lines it may be necessary to add decoupling capacitors along the line further away from the device. Proper grounding of the GND pins is also essential for good RF performance. Either connect the GND pins directly to the ground plane or through vias, or do both. The material that has been used for the evaluation board is FR4 using the stack shown in Fig 4

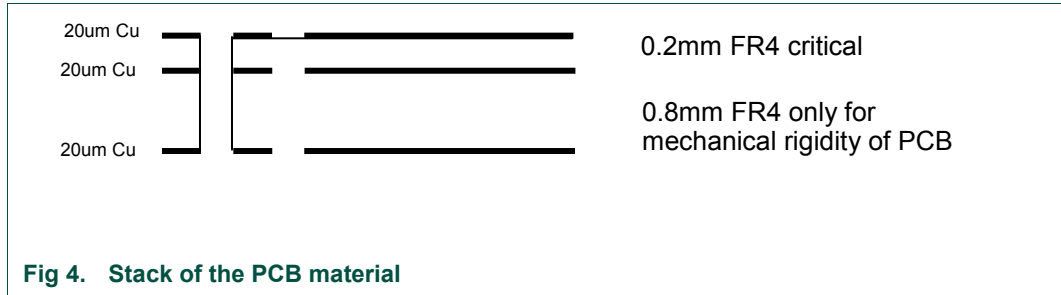

Fig 4. Stack of the PCB material

Material supplier is ISOLA DURAVER;  $\epsilon_r = 4.6 - 4.9$ ;  $\text{Tan}\delta = 0.02$

### 3.4 Bill of materials

Table 1 BOM of the BGU7004 GPS LNA EVB v2.1

Designator	Description	Footprint	Value	Supplier Name/type	Comment
Ac	BGU7004	1.45x1.1mm			LNA MMIC
PCB	v2.1	35x20mm	BGU7004 GPS LNA EVB		
C1	Capacitor	0402	1nF	Murata GRM1555	Decoupling
L1	Inductor	0402	5.6nH	Murata/LQW15A High Q low $R_s$	Input matching
X1,X2	SMA RF connector	-	-	Johnson, End launch SMA 142-0701-841	RF input/ RF output
X3	DC header	-	-	Molex, PCB header, Right Angle, 1 row, 3 way 90121-0763	Bias connector
X4	JUMPER stage	-	-	Molex, PCB header, Vertical, 1 row, 3 way 90120-0763	Connect $V_{en}$ to $V_{cc}$ or separate $V_{en}$ voltage
JU1	Jumper				

#### 3.4.1 Series inductor

The evaluation board is supplied with Murata LQW15series inductor of 5.6nH. This is a wire wound type of inductor with high quality factor (Q) and low series resistance ( $R_s$ ). This type of inductor is recommended in order to achieve the best noise performance. High Q inductors from other suppliers can be used. If it is decided to use other low cost inductors with lower Q and higher  $R_s$  the noise performance will degrade.

## 4. Required Equipment

In order to measure the evaluation board the following is necessary:

- ✓ DC Power Supply up to 30 mA at 1.5 V to 2.85 V;
- ✓ Two RF signal generators capable of generating an RF signal at the operating frequency of 1575.42 MHz, as well as the jammer frequencies 850 MHz, 1713.42 MHz, 1850 MHz and 1851.42 MHz;
- ✓ An RF spectrum analyzer that covers at least the operating frequency of 1575.42 MHz as well as a few of the harmonics, so up to 6 GHz should be sufficient;
- ✓ “Optional” a version with the capability of measuring noise figure is convenient;
- ✓ Amp meter to measure the supply current (optional);
- ✓ A network analyzer for measuring gain, return loss and reverse Isolation;
- ✓ Noise figure analyzer and noise source;
- ✓ Directional coupler;
- ✓ Proper RF cables.

## 5. Connections and setup

The BGU7004 GPS LNA evaluation board is fully assembled and tested. Please follow the steps below for a step-by-step guide to operate the evaluation board and testing the device functions.

1. Connect the DC power supply to the  $V_{cc}$ , and GND terminals. Set the power supply to the desired supply voltage, between 1.5 V and 2.85 V, but never exceed 3.1 V as it might damage the BGU7004.
2. Jumper JU1 is connected between the  $V_{cc}$  terminal of the evaluation board and the  $V_{en}$  pin of the BGU7004.
3. To evaluate the power on settling time  $t_{on}$  and the power off settling time  $t_{off}$ , it is also possible to use a separate voltage on the  $V_{en}$ , eventually this voltage can be supplied by a pulse generator. In this case jumper JU1 should be removed. The definition of  $t_{on}$  is the time from 10 % to 90 % of the maximum signal level and for  $t_{off}$  the time from 90 % to 10 % of the maximum signal level.
4. Connect the RF signal generator and the spectrum analyzer to the RF input and the RF output of the evaluation board, respectively. Do not turn on the RF output of the Signal generator yet, set it to -40 dBm output power at 1575.42 MHz, set the spectrum analyzer at 1575.42 MHz center frequency and a reference level of 0 dBm.
5. Turn on the DC power supply and it should read approximately 5 mA.
6. Enable the RF output of the generator; the spectrum analyzer displays a tone of around -25 dBm at 1575.42 MHz.
7. Instead of using a signal generator and spectrum analyzer one can also use a network analyzer in order to measure gain as well as in- and output return loss.
8. For noise figure evaluation, either a noise-figure analyzer or a spectrum analyzer with noise option can be used. The use of a 15 dB noise source, like the Agilent 364B is recommended. When measuring the noise figure of the evaluation board, any kind of adaptors, cables etc between the noise source and the evaluation board should be avoided, since this affects the noise performance.



9. For noise under jamming conditions, the following is needed. A 15dB ENR noise source, a directional coupler, GPS band pass filter, a noise-figure analyzer or a spectrum analyzer with noise option can be used. See [Fig 12](#)

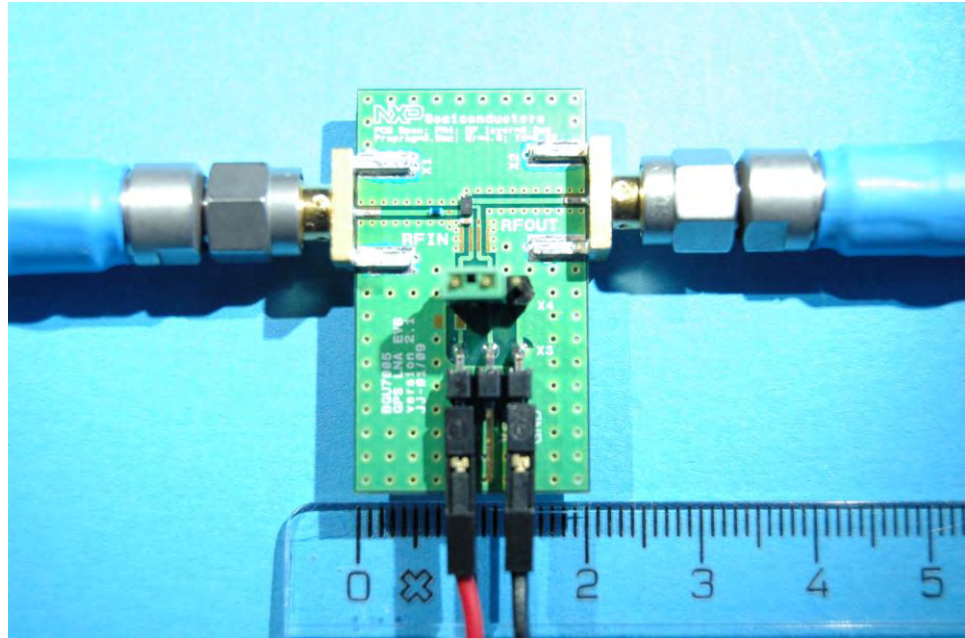

Fig 5. BGU7004 evaluation board including its connections

## 6. Linearity

At the average power levels of  $-130$  dBm that have to be received by a GPS receiver, the system will not have in-band intermodulation problems caused by the GPS-signal itself. Strong out-of-band cell phone TX jammers however can cause linearity problems, and result in third-order intermodulation products in the GPS frequency band.

### 6.1 Out-of-Band input third-order Intercept point

This parameter is being measured by a two-tone measurement where the carriers have been chosen as L1 + 138 MHz and L1 + 276 MHz. Where L1 is the center of the GPS band, 1575.42 MHz. So the two carriers are 1713.42 MHz and 1851.42 MHz that can be seen as two TX jammers in UMTS FDD and GSM1800 cell phone systems.

One third-order product ( $2f_1 - f_2$ ) generated in the LNA due to amplifier third order non-linearities can fall at the desired 1575.42-MHz frequency as follows.

$$2f_1 - f_2 = 2(1713.42 \text{ MHz}) - 1851.42 \text{ MHz} = 1575.42 \text{ MHz}$$

This third-order product can influence the sensitivity of the GPS receiver drastically. So this third-order intermodulation product needs to be as low as possible, meaning the out-of-band intercept point must be as high as possible.

[Fig 6](#), [Fig 7](#) and [Fig 8](#) show the O\_IIP3 of the BGU7004 at different supply voltages.



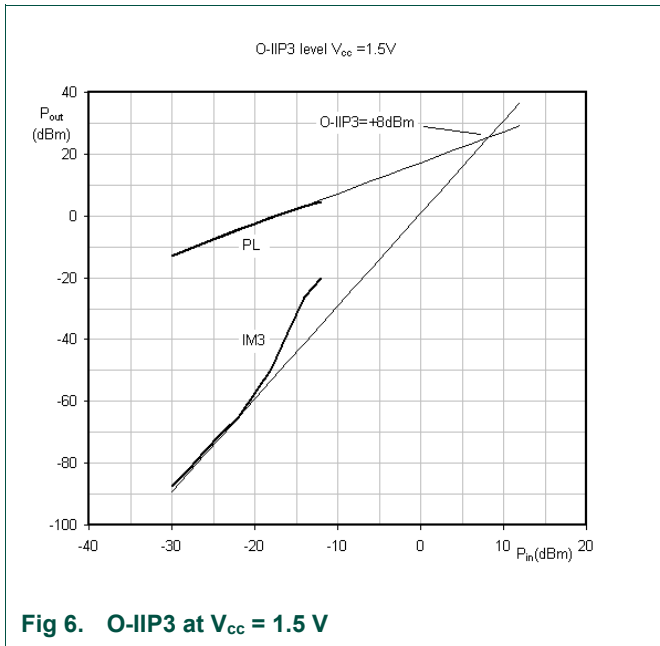

Fig 6. O-IIP3 at  $V_{cc} = 1.5 V$

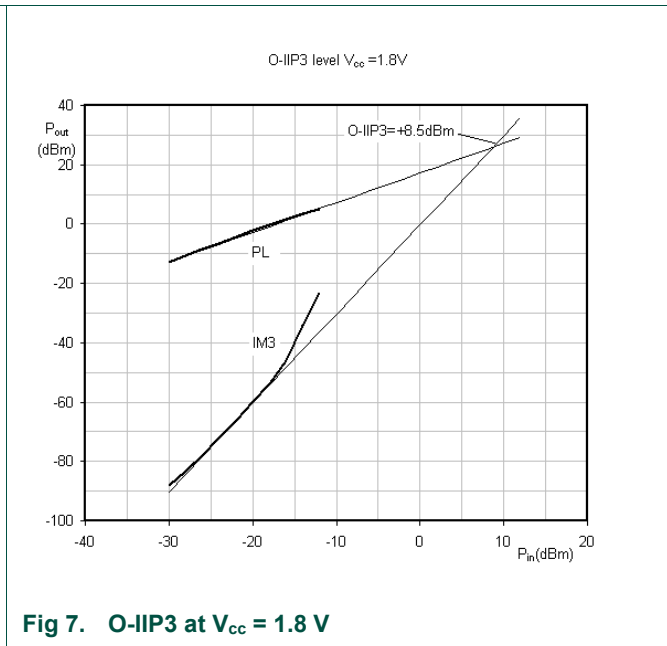

Fig 7. O-IIP3 at  $V_{cc} = 1.8 V$

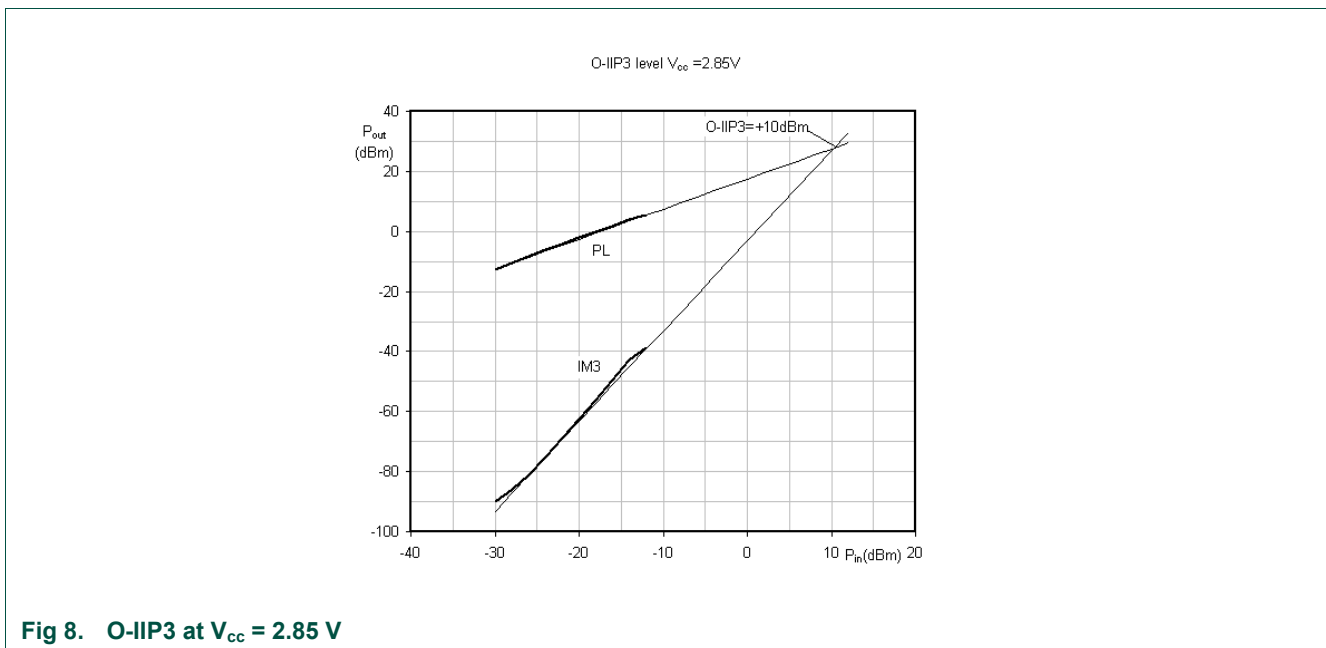

Fig 8. O-IIP3 at  $V_{cc} = 2.85 V$

### 6.2 In-band 1dB gain compression due to 850 MHz and 1850 MHz jammers

As already stated before, signal levels in the GPS frequency band of  $-130$  dBm average will not cause linearity problems in the GPS band itself. This of course is also valid for the 1 dB gain compression in-band. The 1 dB compression point at 1575.42 MHz caused by cell phone TX jammers however is important. Measurements have been carried out using the set-up shown in [Fig 9](#).

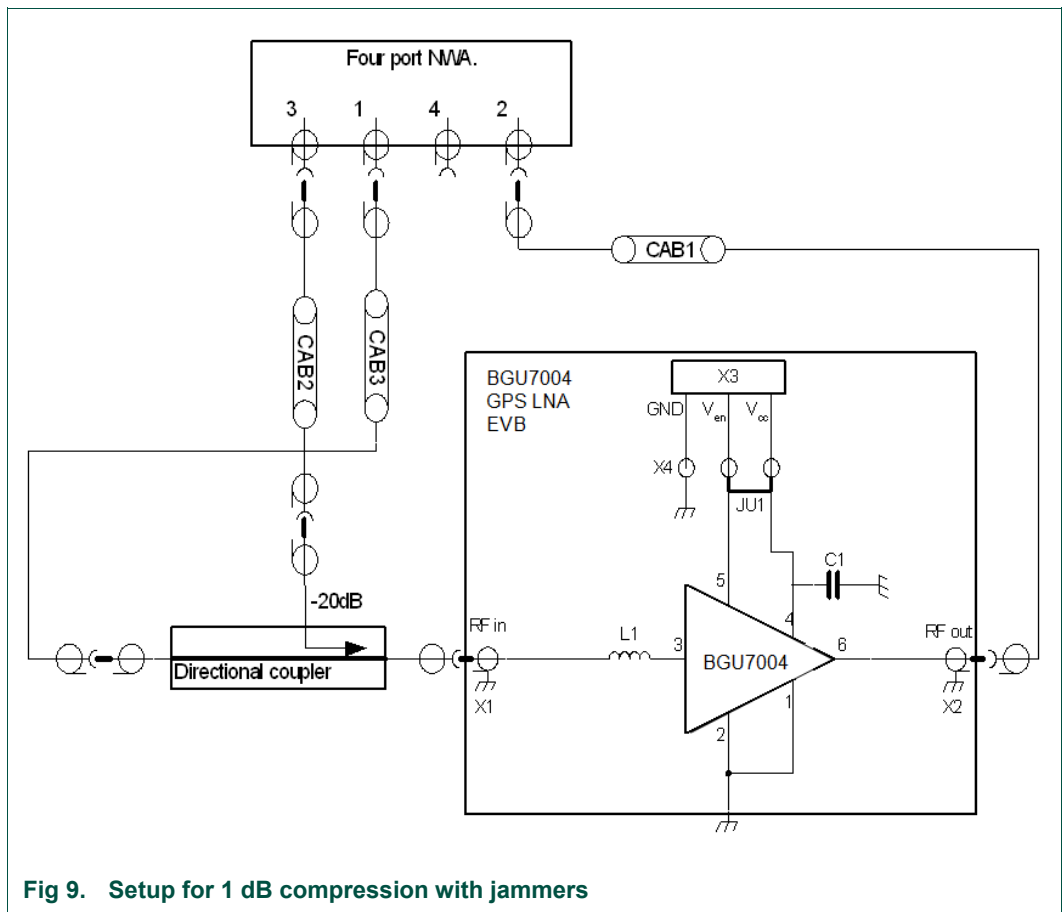

Fig 9. Setup for 1 dB compression with jammers

The gain was measured in the GPS frequency band between port 1 and 2, while simultaneously a jammer power signal was swept on port 3. Please note that the drive power of the jammer is 20 dB lower at the input of the DUT caused by the directional coupler. Fig 10 and Fig 11 show the gain compression curves with 850 MHz and 1850 MHz jammers respectively.

The analyzer read out for 850 MHz jammer is +9.3 dBm (see Figure 10) taking into account the 20 dB attenuation of the directional coupler means  $P_{i1\text{ dB}} = -10.7\text{ dBm}$ .

For 1850 MHz the read out is +14.42 dBm (see Figure 11) taking into account the 20 dB attenuation of the directional coupler means  $P_{i1\text{ dB}} = -5.58\text{ dBm}$ .

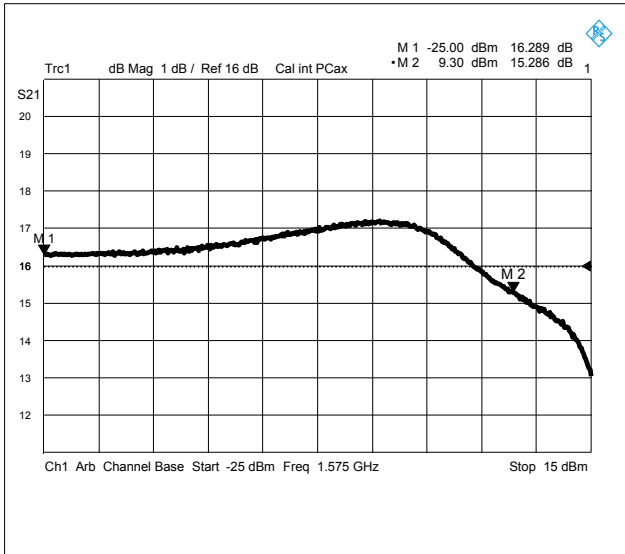

Fig 10. 1dB Gain compression 1.575 GHz 850 Mhz jammer

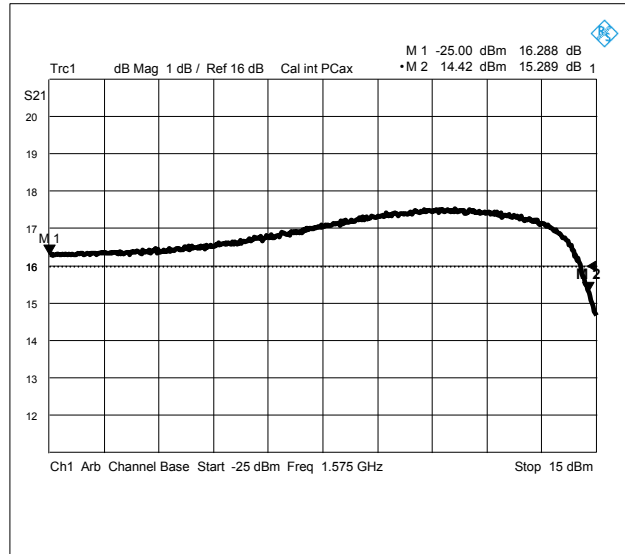

Fig 11. 1dB Gain compression 1.575 GHz 1850 Mhz jammer

## 7. Noise figure as function of jammer power at 850 MHz and 1850 MHz

Noise figure under jamming conditions is a measure of how the LNA behaves when e.g. a GSM TX interfering signal is at the input of the GPS antenna. To measure this behavior the setup shown in Fig 12 is used.

The jammer signal is coupled via a directional coupler to the DUT: this is to avoid the jammer signal damaging the noise source. The GPS BPF is needed to avoid driving the second-stage LNA in saturation.

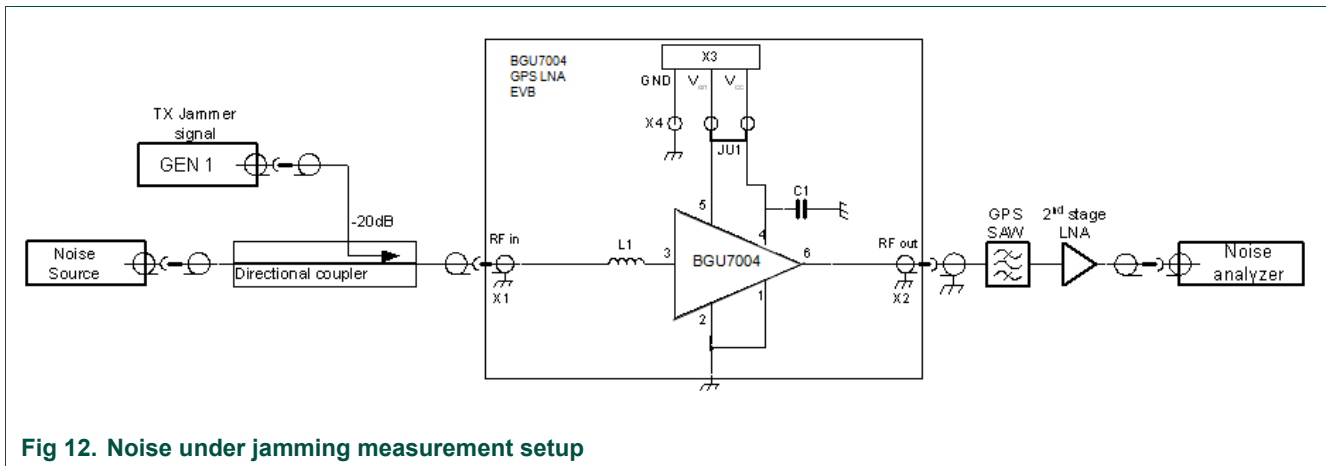
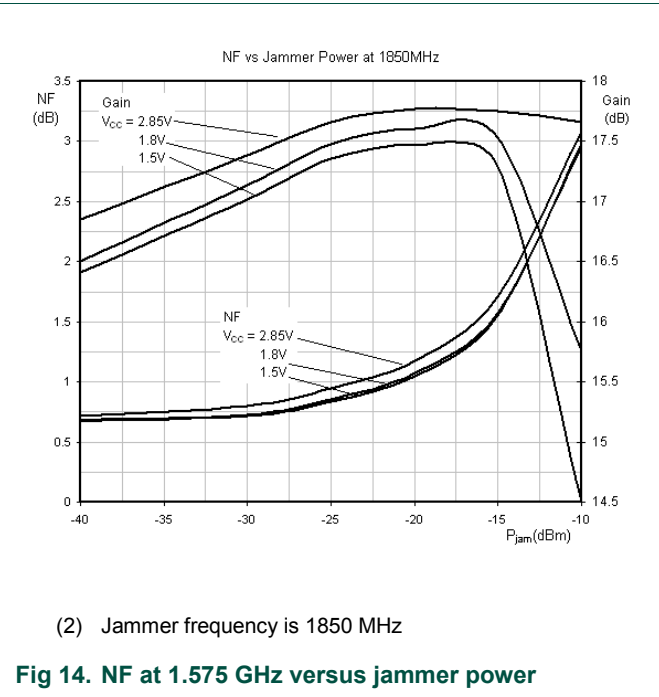
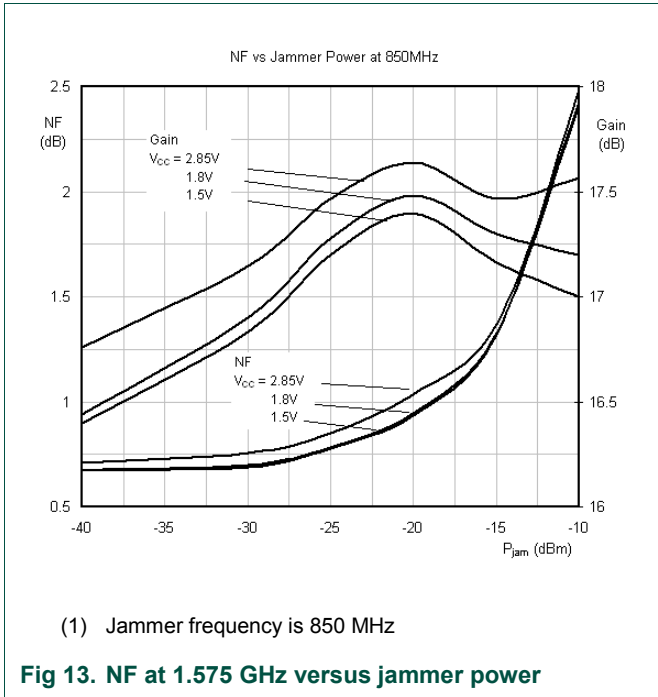

Fig 12. Noise under jamming measurement setup

In Fig 13 and Fig 14, the noise figure as a function of jammer power is given for 850 MHz and 1850 MHz jammer signals.



## 8. Typical evaluation board results

**Table 2, typical results measured on the Evaluation Boards.**

Operating Frequency is  $f=1575.42\text{MHz}$  unless otherwise specified; Temp = 25 °C.

Parameter	Symbol	BGU7004	BGU7004	BGU7004	Unit	Remarks
Supply Voltage	$V_{cc}$	1.5	1.8	2.85	V	
Supply Current	$I_{cc}$	4.6	4.7	5.2	mA	
Noise Figure	NF <a href="#">[1]</a>	0.86	0.85	0.86	dB	
Power Gain	850MHz	8.4	10	8.91		
	1575.42MHz	$G_p$	16.3	16.4	16.8	dB
	1850MHz		14.6	14.2	15.2	
Input Return Loss	$RL_{in}$	6.9	7	7.6	dB	
Output Return Loss	$RL_{out}$	15.9	16.45	17	dB	
Reverse Isolation	$ISL_{rev}$	22.9	23.1	23.6	dB	
Input 1dB Gain Compression	850MHz		-11.6	-10.6	-10.5	
	1575.42MHz	$P_{i1dB}$	-10.58	-9.37	-7.7	dBm
	1850MHz		-8.74	-7.6	-6.3	
Input third order intercept point	$IP3_i$ <a href="#">[2]</a>	8	8.5	10	dBm	
Power settling time	$T_{on}$	1.4	1	0.9	$\mu\text{s}$	Measured from 10% to 90% and 90% to 10 % of the max power.
	$T_{off}$	1	0.95	0.9		

[1] The NF and Gain figures are being measured at the SMA connectors of the evaluation board, so the losses of the connectors and the PCB of approximately 0.1dB are not subtracted.

[2] Jammers at  $f_1 = f+138\text{ MHz}$  and  $f_2 = f+276\text{ MHz}$ , where  $f = 1575.42\text{ MHz}$ .

## 9. Legal information

### 9.1 Definitions

**Draft** — The document is a draft version only. The content is still under internal review and subject to formal approval, which may result in modifications or additions. NXP Semiconductors does not give any representations or warranties as to the accuracy or completeness of information included herein and shall have no liability for the consequences of use of such information.

### 9.2 Disclaimers

**General** — Information in this document is believed to be accurate and reliable. However, NXP Semiconductors does not give any representations or warranties, expressed or implied, as to the accuracy or completeness of such information and shall have no liability for the consequences of use of such information.

**Right to make changes** — NXP Semiconductors reserves the right to make changes to information published in this document, including without limitation specifications and product descriptions, at any time and without notice. This document supersedes and replaces all information supplied prior to the publication hereof.

**Suitability for use** — NXP Semiconductors products are not designed, authorized or warranted to be suitable for use in medical, military, aircraft,

space or life support equipment, nor in applications where failure or malfunction of a NXP Semiconductors product can reasonably be expected to result in personal injury, death or severe property or environmental damage. NXP Semiconductors accepts no liability for inclusion and/or use of NXP Semiconductors products in such equipment or applications and therefore such inclusion and/or use is for the customer's own risk.

**Applications** — Applications that are described herein for any of these products are for illustrative purposes only. NXP Semiconductors makes no representation or warranty that such applications will be suitable for the specified use without further testing or modification.

**Export control** — This document as well as the item(s) described herein may be subject to export control regulations. Export might require a prior authorization from national authorities

### 9.3 Trademarks

Notice: All referenced brands, product names, service names and trademarks are property of their respective owners.

**10. Contents**

---

- 1. Introduction ..... 3**
- 2. General description..... 4**
- 3. Application Board ..... 4**
  - 3.1 Application Circuit..... 5
  - 3.2 Board Layout..... 5
  - 3.3 PCB layout ..... 6
  - 3.4 Bill of materials ..... 6
  - 3.4.1 Series inductor ..... 6
- 4. Required Equipment ..... 7**
- 5. Connections and setup..... 7**
- 6. Linearity ..... 8**
  - 6.1 Out-of-Band input third-order Intercept point..... 8
  - 6.2 In-band 1dB gain compression due to 850 MHz and 1850 MHz jammers ..... 9
- 7. Noise figure as function of jammer power at 850 MHz and 1850 MHz ..... 11**
- 8. Typical evaluation board results..... 13**
- 9. Legal information ..... 14**
  - 9.1 Definitions..... 14
  - 9.2 Disclaimers..... 14
  - 9.3 Trademarks ..... 14
- 10. Contents..... 15**

---

Please be aware that important notices concerning this document and the product(s) described herein, have been included in the section 'Legal information'.

---

© NXP B.V. 2011. All rights reserved.

For more information, please visit: <http://www.nxp.com>  
 For sales office addresses, email to: [salesaddresses@nxp.com](mailto:salesaddresses@nxp.com)

Date of release: 14 June 2011  
 Document identifier: UM10491