

Features

Unregulated Converters

- 6V Output for GaN driver applications
- Pot-Core transformer with separated windings
- High 5.2kVDC isolation In compact Size
- Low isolation capacitance (10pF max.)
- UL and EN certified



RP-xx06S

1 Watt
SIP7 for
GaN Application



Description

High slew rate GaN transistor drivers require an isolated 6V supply with high isolation voltage and low isolation capacitance.

The RP-xx06S series have been specially designed to fulfill this demanding requirement with 5200VDC isolation and <10pF isolation capacitance. The internal transformer uses a pot-core to physically separate the input and output windings, yet the converter still fits into an industry standard SIP7 case. Input voltage options of 5, 12, 15 or 24V are available and the RP-xx06S series is safety certified to the latest UL/IEC60950 standard.

Selection Guide

Part Number	nom. Input Voltage [VDC]	Output Voltage [VDC]	Output Current [mA]	Efficiency typ. ⁽¹⁾ [%]	max. Capacitive Load ⁽²⁾ [µF]
RP-0506S	5	6	167	81	1000
RP-1206S	12	6	167	77	1000
RP-1506S	15	6	167	83	1000
RP-2406S	24	6	167	82	1000

Notes:

Note1: Efficiency is tested at nominal input and full load at +25°C ambient

Note2: Max. Cap. Load is tested at nominal input and full resistive load

Model Numbering

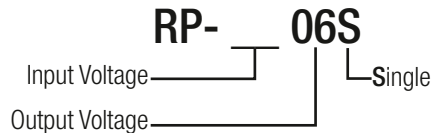

Ordering Examples

RP-0506S = 5V Input, 6V Output, Single Output

RP-1506S = 15V Input, 6V Output, Single Output



UL60950-1 certified
IEC/EN60950-1 certified
IEC/EN60601-1 certified

Specifications (measured @ Ta= 25°C, nom. Vin, full load unless otherwise specified)

BASIC CHARACTERISTICS					
Parameter	Condition		Min.	Typ.	Max.
Internal Input Filter	capacitor type				
Input Voltage Range	nom. Vin =	5VDC	4.5VDC	5VDC	5.5VDC
		12VDC	10.8VDC	12VDC	13.2VDC
		15VDC	13.5VDC	15VDC	16.5VDC
		24VDC	21.6VDC	24VDC	26.4VDC
Input Current	nom. Vin =	5VDC		270mA	
		12VDC		120mA	
		15VDC		86mA	
		24VDC		57mA	
Quiescent Current	nom. Vin =	5VDC		20mA	
		12VDC		10mA	
		15VDC		8mA	
		24VDC		7mA	

continued on next page



www.recom-power.com/eval-ref-boards

Specifications (measured @ Ta= 25°C, nom. Vin, full load unless otherwise stated)

BASIC CHARACTERISTICS

Parameter	Condition	Min.	Typ.	Max.
Minimum Load		0%		
Start-up time				250ms
Internal Operating Frequency		50kHz	75kHz	120kHz
Output Ripple and Noise ^③	20MHz BW		50mVp-p	100mVp-p

Notes:

Note3: Measurements are made with a 0.1µF MLCC across output (low ESR)

Efficiency vs. Load

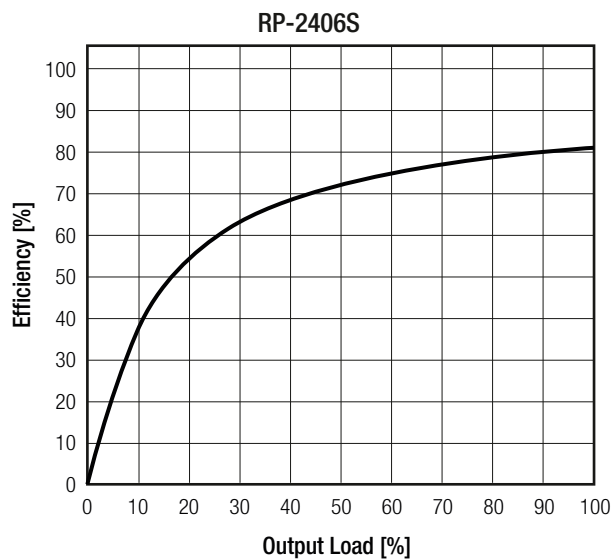

REGULATIONS

Parameter	Condition	Value	
Output Accuracy		±5.0% max.	
Line Regulation	low line to high line, full load	±1.2% typ.	
Load Regulation	10% to 100% load	5VDC	±8.0% typ. / ±15.0% max.
		12VDC	±7.0% typ. / ±15.0% max.
		15VDC	±4.0% typ. / ±15.0% max.
		24VDC	±3.0% typ. / ±15.0% max.

Accuracy vs. Load

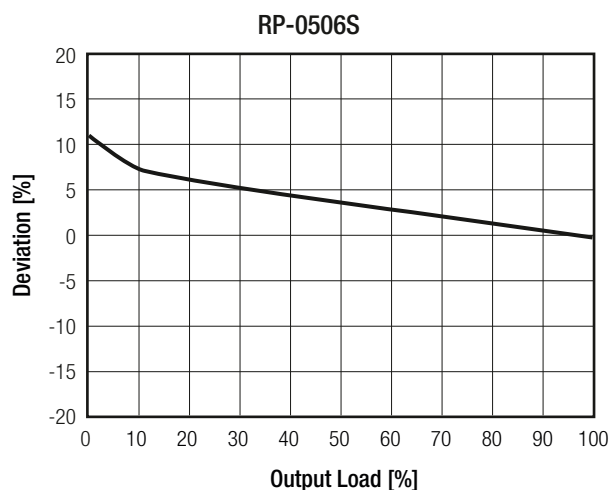

Specifications (measured @ Ta= 25°C, nom. Vin, full load unless otherwise stated)

PROTECTIONS			
Parameter	Type		Value
	Isolation Voltage ⁽⁴⁾	I/P to O/P	
Isolation Resistance			15GΩ min.
Isolation Capacitance			10pF max.
Leakage Current			0.35μA
Insulation Grade	according to IEC/EN60950-1 electric strength test		basic
<p>Notes:</p> <p>Note4: For repeat Hi-Pot testing, reduce the ime and/or the test voltage</p>			

ENVIRONMENTAL			
Parameter	Condition		Value
Operating Temperature Range	without derating @ natrual convection (0.1m/s, see graph)		-40°C to +80°C
Maximum Case Temperature			+105°C
Temperature Coefficient			±0.03%/°C
Thermal Impedance	0.1m/s, horizontal		53°C/W
Operating Altitude	according to EN/IEC60601-1 report		3000m
Operating Humidity	non-condensing		95% RH max.
Pollution Degree			PD2
MTBF	according to MIL-HDBK-217F, G.B.	+25°C	10100 x 10 ³ hours
		+80°C	6900 x 10 ³ hours

Derating Graph

(@ Chamber and natural convection 0.1 m/s)

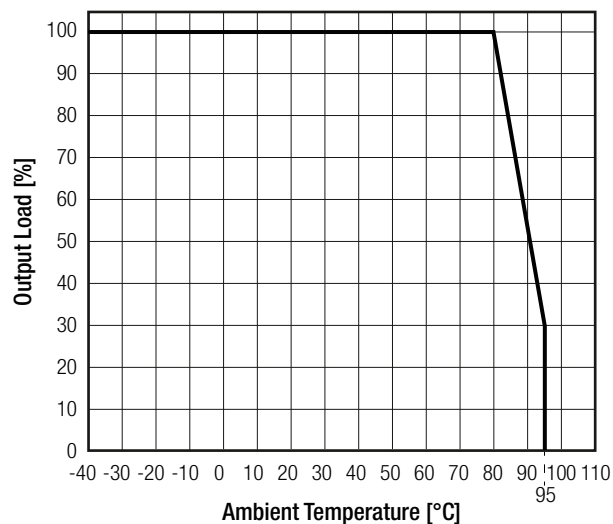

Specifications (measured @ Ta= 25°C, nom. Vin, full load unless otherwise stated)

SAFETY AND CERTIFICATIONS

Certificate Type (Safety)	Report / File Number	Standard
Information Technology Equipment, General Requirements for Safety	SPCLVD1602031	IEC60950-1, 2nd Edition, 2005 + Am2, 2013 EN60950-1, 2006 + Am2, 2013
Information Technology Equipment, General Requirements for Safety	E358085-A6-UL	UL60950-1, 1st Edition, 2007 CAN/CSA C22.2 No. 60950-1, 1st Edition, 2006
Medical Electric Equipment, General Requirements for Safety and Essential Performance	SPCMDD1205098-4	IEC60601-1, 2005 + CORR 2, 2007 EN60601-1, 2006
EAC	RU-AT.49.09571	TP TC 004/2011
RoHs 2+		RoHS 10/10, 2011/65/EU + AM-2015/863

EMC Compliance

EMC Compliance	Condition	Standard / Criterion
Electromagnetic compatibility of multimedia equipment - Emission requirements	without external filter	EN55032, Class A or B

EMC Filtering according to EN55032 Class A and Class B

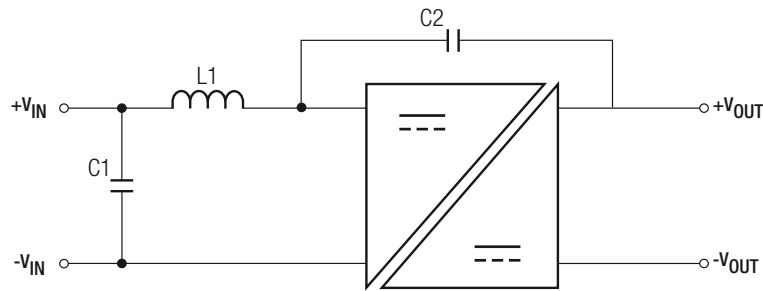

Component List Class A

C1	C2	L1
22µF	470pF, 6kVDC	N/A

Component List Class B

MODEL	C1	C2	L1
RP-0506S	10µF	470pF, 6kVDC	10µH
RP-1206S	4.7µF		22µH
RP-1506S			47µH
RP-2406S	2.2µF		

DIMENSION and PHYSICAL CHARACTERISTICS

Parameter	Type	Value
Material	case potting	black plastic, (UL94 V-0) epoxy, (UL94 V-0)
Package Dimension (LxWxH)		19.65 x 7.05 x 10.2mm
Package Weight		2.6g

continued on next page

Specifications (measured @ Ta= 25°C, nom. Vin, full load unless otherwise stated)

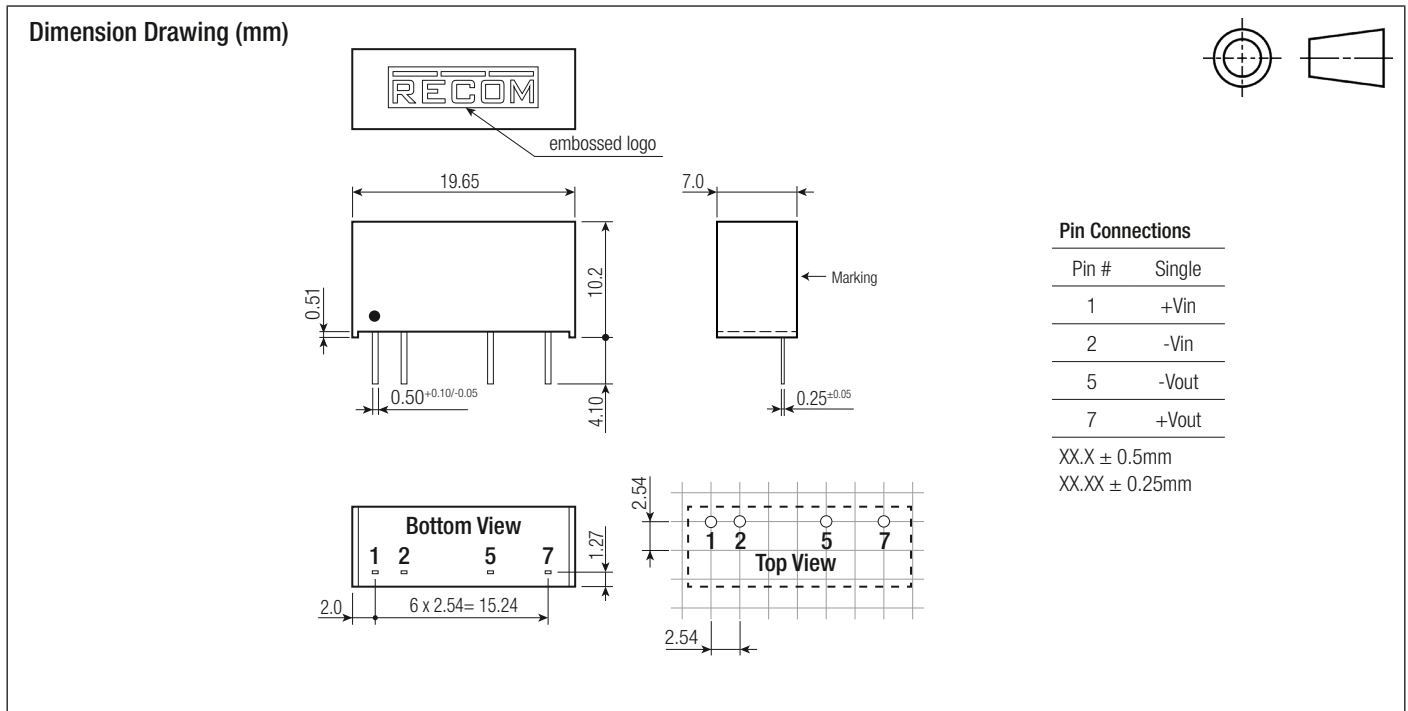

INSTALLATION and APPLICATION

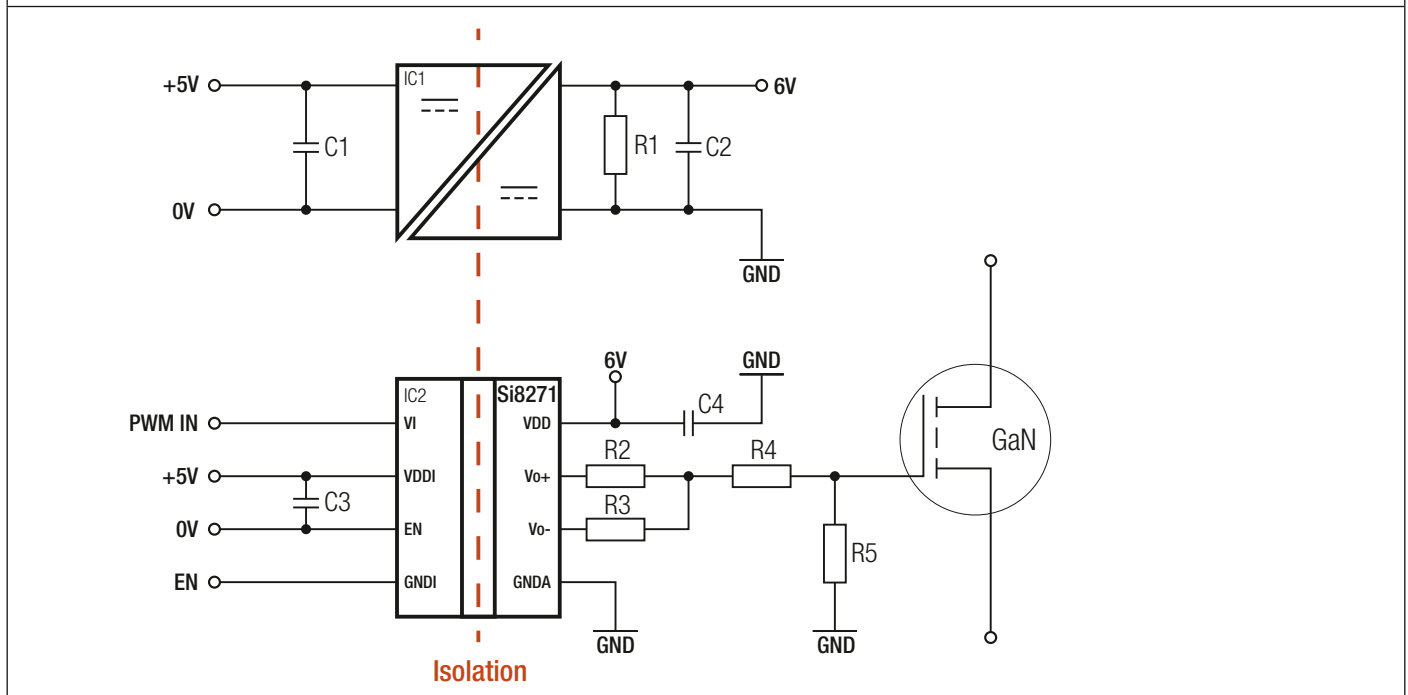

PACKAGING INFORMATION

Packaging Dimension (LxWxH)	tube	520.0 x 16.0 x 9.mm
Packaging Quantity	tube	25pcs
Storage Temperature Range		-55°C to +125°C
Storage Humidity		95% RH max.

The product information and specifications may be subject to changes even without prior written notice. The product has been designed for various applications; its suitability lies in the responsibility of each customer. The products are not authorized for use in safety-critical applications without RECOM's explicit written consent. A safety-critical application is an application where a failure may reasonably be expected to endanger or cause loss of life, inflict bodily harm or damage property. The applicant shall indemnify and hold harmless RECOM, its affiliated companies and its representatives against any damage claims in connection with the unauthorized use of RECOM products in such safety-critical applications.