

QT-Brightek SMD Display Series

0.56" Four Digit SMD Display

Part No.: QBQS56ZXX

XX= Color

Z= 1: Common Cathode

Z = 0: Common Anode

Table of Contents:

Introduction	3
Electrical / Optical Characteristic: (Ta=25 °C)	4
Absolute Maximum Rating	4
Pin Configuration	5
Characteristic Curves.....	6
Solder Profile & Footprint.....	8
Packing & Labeling	9
Ordering Information	10
Revision History	11
Disclaimer	11

Product: QBQS56ZXX	Date: November 19, 2015	Page 2 of 11
	Version# 1.1	

Introduction

Feature:

- 0.56" four digit seven segments display
- Low power consumption
- Packed in tape & reel
- White segment and grey surface
- XX = color code
- Z=1: Common Cathode or 0: Common Anode

Description:

These 0.56" four digit seven segments displays are made with white segment and grey surface. The viewing distance is up to seven meters.

Application:

- Instrument panels
- Indoor/Outdoor display board
- Audio equipment

Certification & Compliance:

- TS16949
- ISO9001
- RoHS Compliant



Dimension:

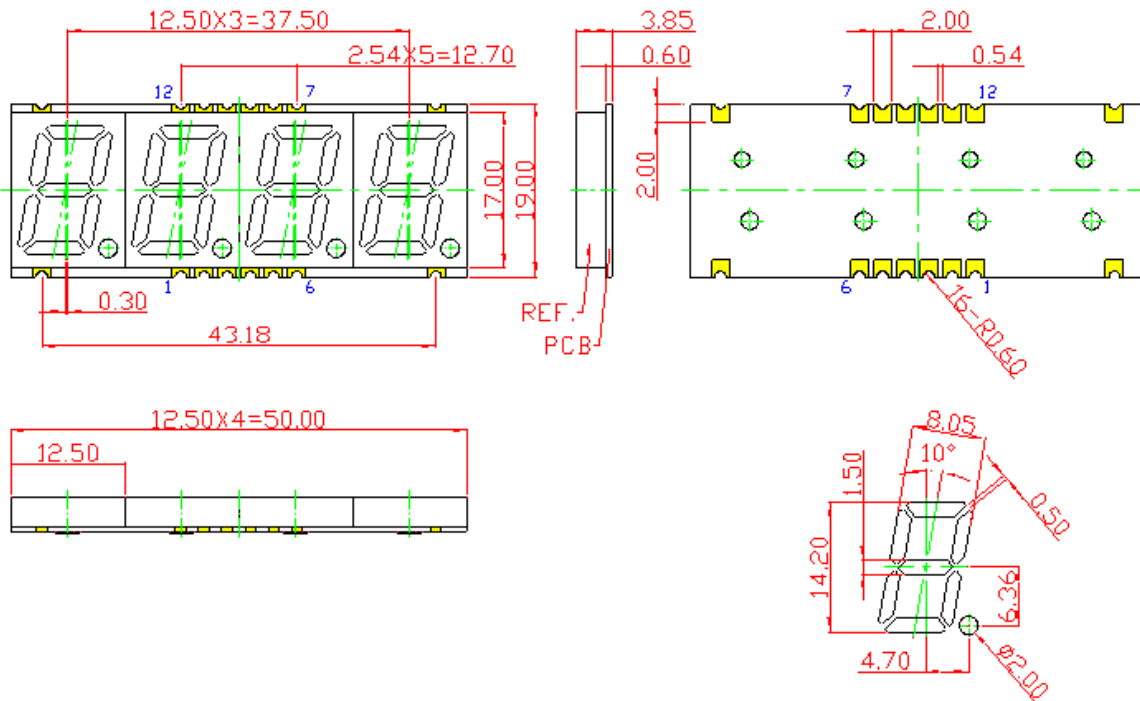

Units: mm / tolerance = +/-0.25mm

Electrical / Optical Characteristic: (Ta=25 °C)

Product		Material	Color	I _F (mA)	V _F (V)		λ _d (nm)			I _V (mcd)
CC	CA				Typ.	Max.	Min.	Typ.	Max.	Typ.
QBQS561R	QBQS560R	AllnGaP	Red	20	2.0	2.6	619	625	629	40
QBQS561S	QBQS560S	AllnGaP	Deep Red	20	2.0	2.6	636	640	646	10
QBQS561Y	QBQS560Y	AllnGaP	Yellow	20	2.0	2.6	585	590	595	40
QBQS561O	QBQS560O	AllnGaP	Orange	20	2.0	2.6	602	605	612	40
QBQS561AG	QBQS560AG	AllnGaP	Yellow Green	20	2.1	2.6	566	571	576	16
QBQS561IG	QBQS560IG	InGaN	True Green	20	3.0	4.0	515	520	530	200
QBQS561IB	QBQS560IB	InGaN	Blue	20	3.2	4.0	464	470	474	60

Absolute Maximum Rating

Material	P _d (mW)	Derating linear from 25°C per dice (mA/°C)	I _F (mA)	I _{FP} (mA)*	V _R (V)	T _{OP} (°C)	T _{ST} (°C)	T _{SO_L} (°C)**
AllnGaP	70	0.28	25	90	5	-40 to +105	-40 to +105	260
InGaN	120	0.3	30	100	5	-40 to +105	-40 to +105	260

*Duty 1/10 @ 1KHz

**IR Reflow for no more than 5 sec @ 260 °C

Pin Configuration

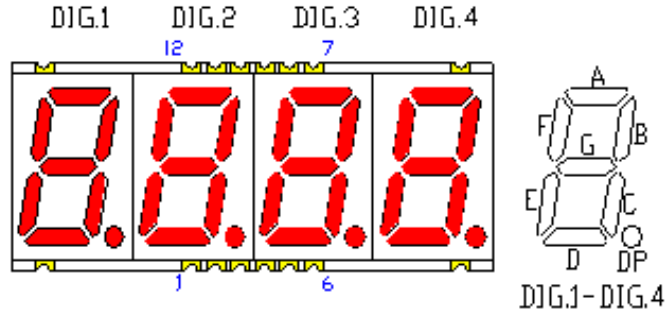

CC

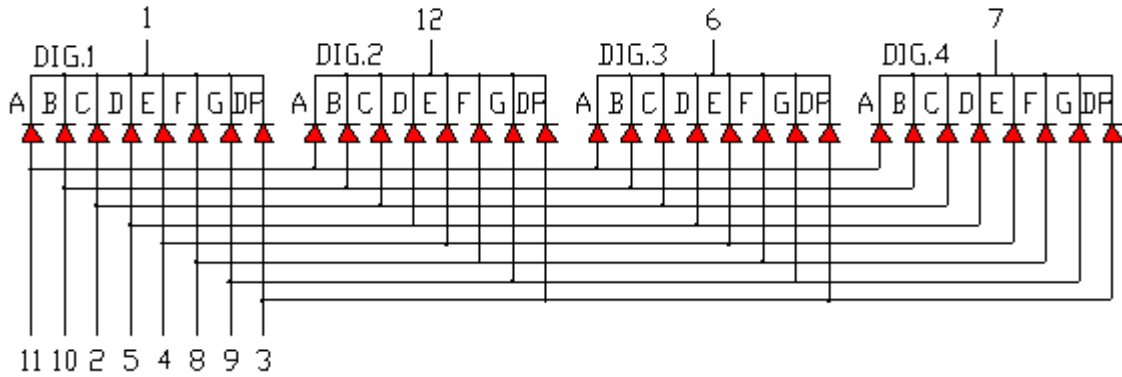

CA

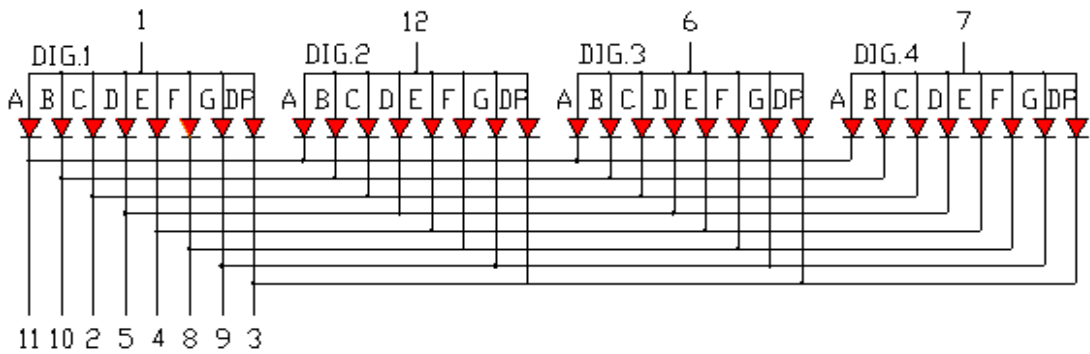

Characteristic Curves

AllnGaP

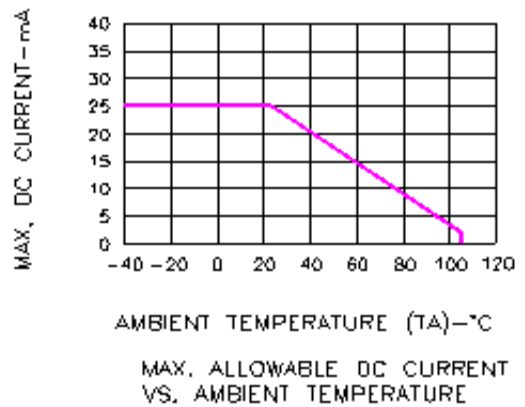
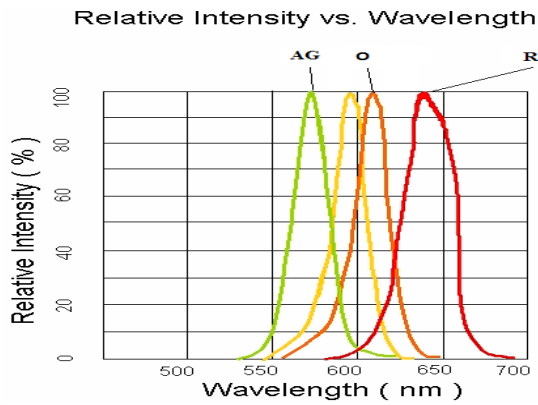
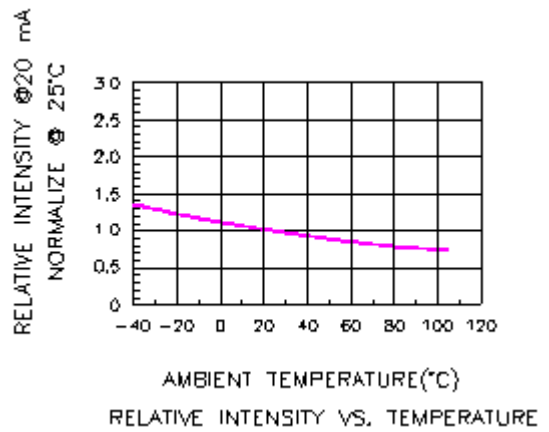
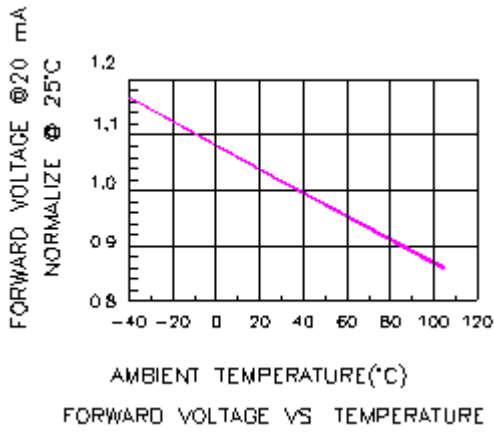
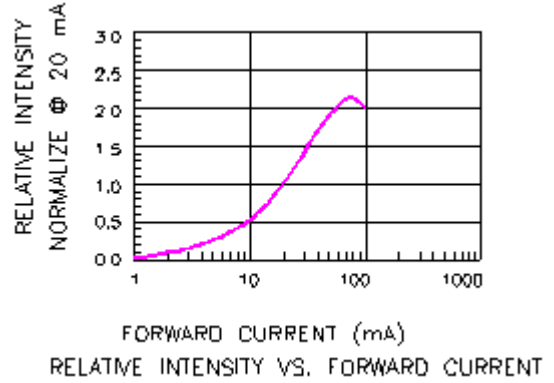
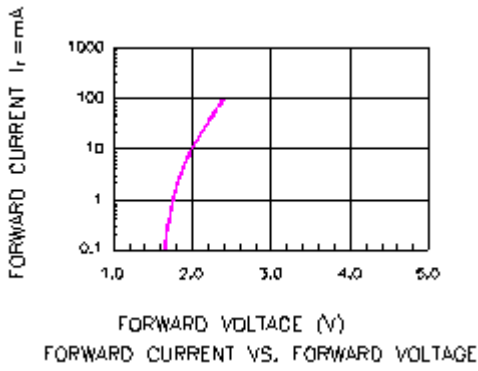

InGaN

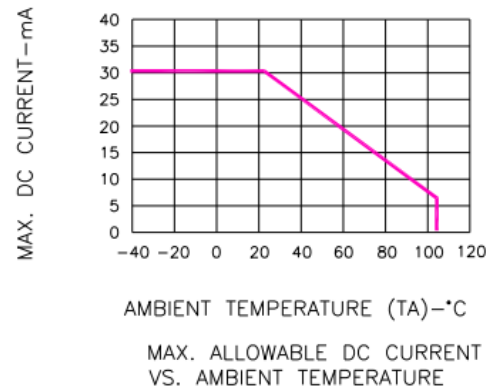
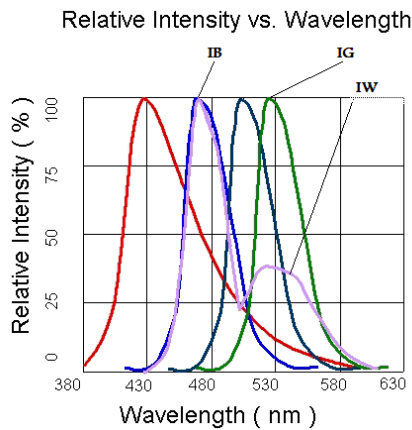
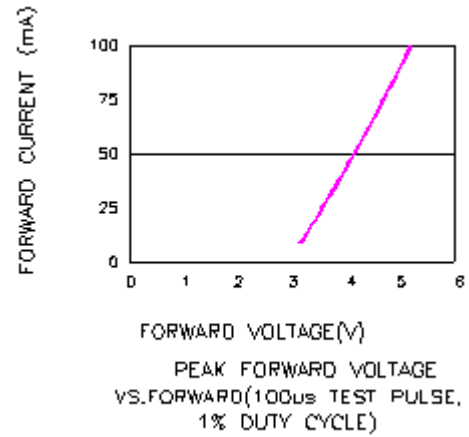
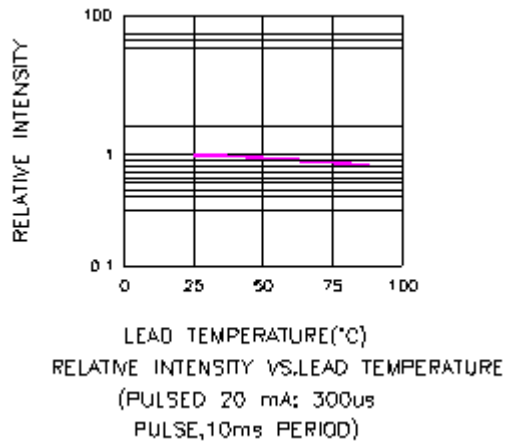
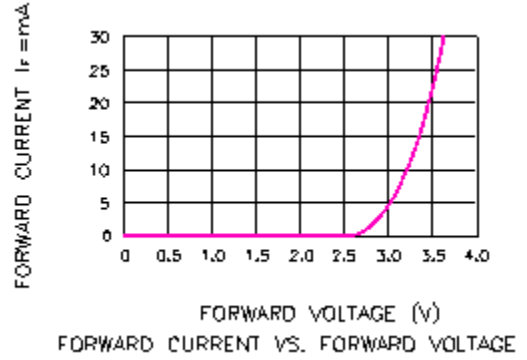
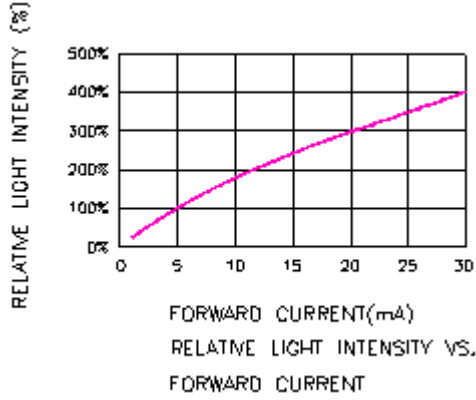

Solder Profile & Footprint

Lead-free Solder Profile:

Pb free reflow soldering Profile

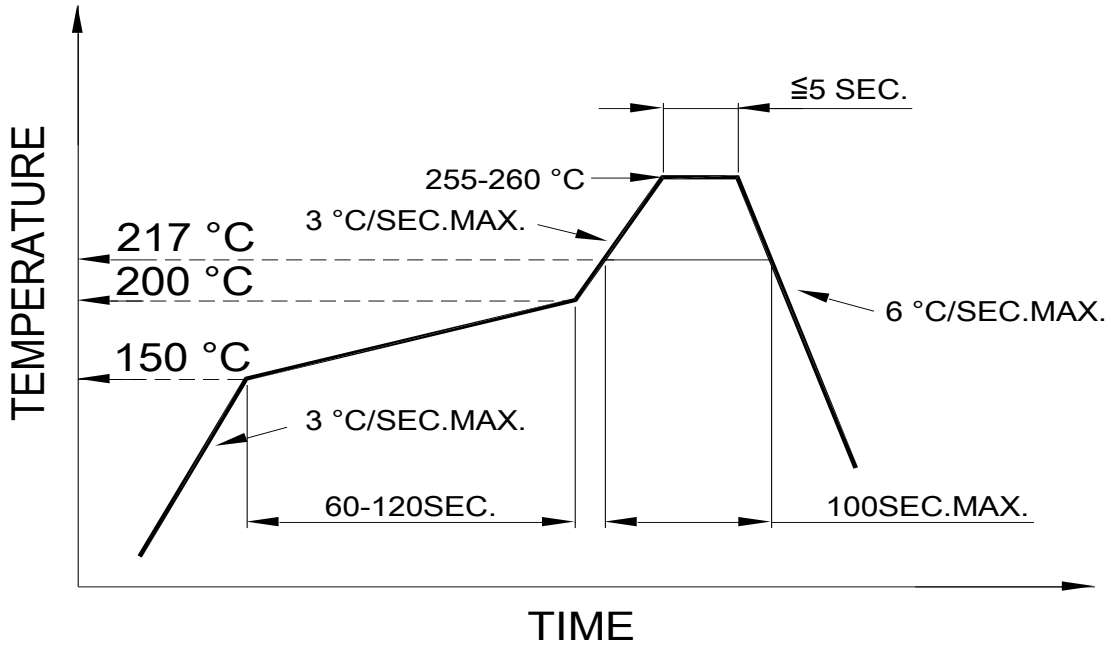

Recommended Pad Layout

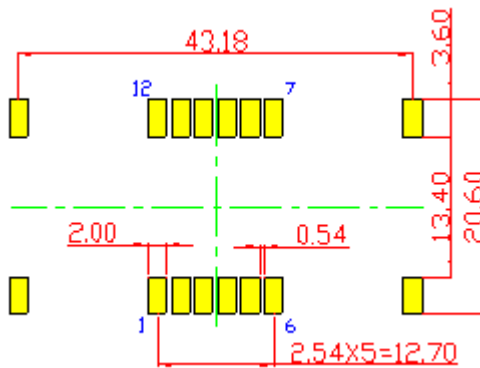

Units: mm

Tolerance: ± 0.25mm

Packing & Labeling

Reel Dimension:

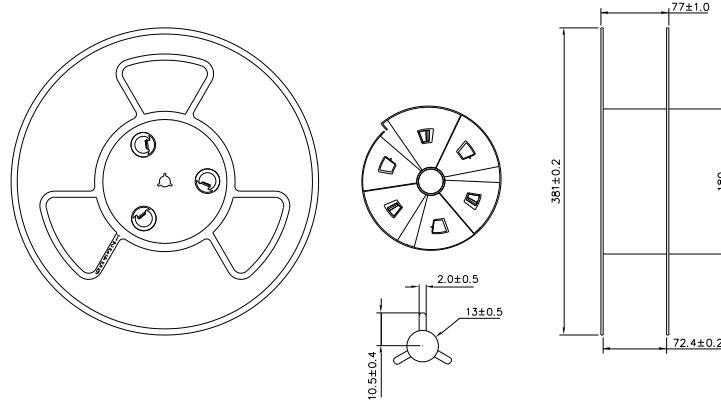

Unit: mm

Packing and Label Specification:

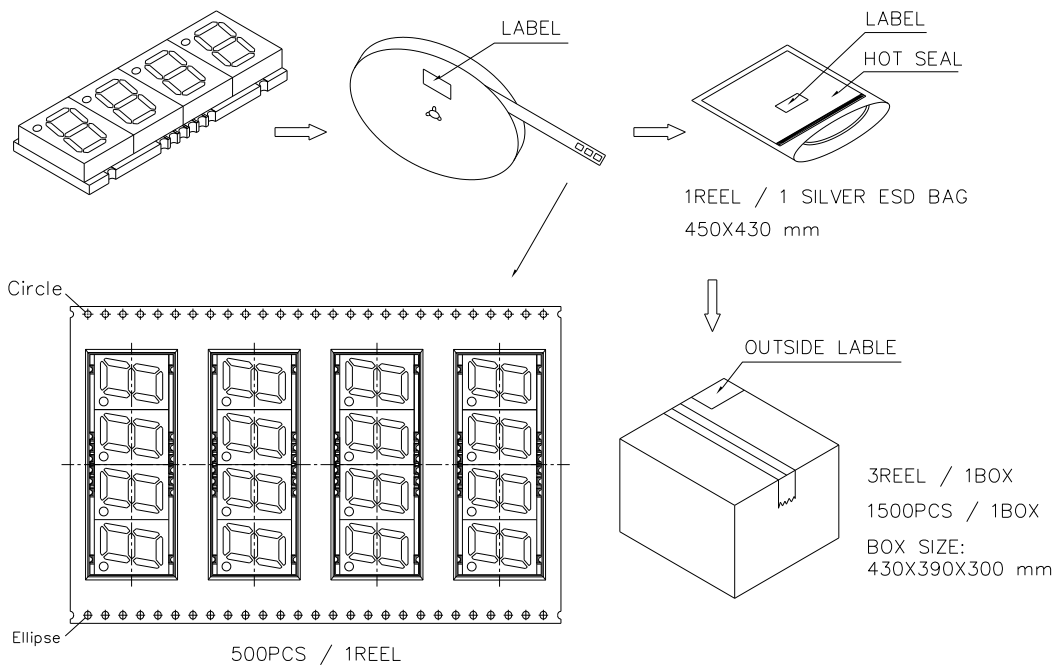

Ordering Information

Product		Orderable Part #		Spec Range	Quantity per Reel
CC	CA	CC	CA		
QBQS561R	QBQS560R	QBQS561R	QBQS560R	I _v =40mcd typ. @ I _F =20mA, λ _D : 625nm typ.	500
QBQS561S	QBQS560S	QBQS561S	QBQS560S	I _v =10mcd typ. @ I _F =20mA, λ _D : 640nm typ.	500
QBQS561Y	QBQS560Y	QBQS561Y	QBQS560Y	I _v =40mcd typ. @ I _F =20mA, λ _D : 590nm typ.	500
QBQS561O	QBQS560O	QBQS561O	QBQS560O	I _v =40mcd typ. @ I _F =20mA, λ _D : 605nm typ.	500
QBQS561AG	QBQS560AG	QBQS561AG	QBQS560AG	I _v =16mcd typ. @ I _F =20mA, λ _D : 571nm typ.	500
QBQS561IG	QBQS560IG	QBQS561IG	QBQS560IG	I _v =200mcd typ. @ I _F =20mA, λ _D : 520nm typ.	500
QBQS561IB	QBQS560IB	QBQS561IB	QBQS560IB	I _v =60mcd typ. @ I _F =20mA, λ _D : 470nm typ.	500

Revision History

Description:	Revision #	Revision Date
New Release of QBQS56ZXX	V1.0	06/24/2011
Update spec, add more color options	V1.1	11/19/2015

Disclaimer

QT-BRIGHTEK reserves the right to make changes without further notice to any products herein to improve reliability, function or design. QT-BRIGHTEK does not assume any liability arising out of the application or use of any product or circuit described herein; neither does it convey any license under its patent rights, nor the rights of others.

Life Support Policy

QT-BRIGHTEK's products are not authorized for use as critical components in life support devices or systems without the express written approval of QT-BRIGHTEK. As used herein:

1. Life support devices or systems are devices or systems which, (a) are intended for surgical implant into the body, or (b) support or sustain life, and (c) whose failure to perform when properly used in accordance with instructions for use provided in the labeling, can be reasonably expected to result in a significant injury of the user.
2. A critical component in any component of a life support device or system whose failure to perform can be reasonably expected to cause the failure of the life support device or system, or to affect its safety or effectiveness.