

IEC Appliance Inlet C8, Snap-in Mounting, Front Side, Solder, PCB or Quick-connect Terminal



Snap-in version



See below:
[Approvals and Compliances](#)

Description

- Panel Mount :
 Snap-in version , Front Side
- Appliance Inlet , Pin temperature 70 °C , Protection class II
- Solder, Quick Connect or PCB Terminal

Characteristics

- Contact pins are turned from solid material

References

- Alternative: version for screw mounting [2576](#)
- Alternative: version with line filter [5008](#)
- Alternative: Inlet with retainer and country specific cord set [2578 retaining kit](#)

Weblinks

[pdf datasheet](#), [html-datasheet](#), [General Product Information](#), [Distributor-Stock-Check](#), [Accessories](#), [Detailed request for product](#)

Technical Data

Ratings IEC	2.5 A / 250VAC; 50Hz
Ratings UL/CSA	2.5 A / 250VAC; 60Hz
	7 A / 125 VAC; 60 Hz
Dielectric Strength	> 3 kVAC between L-N > 1.5 kVAC between L/N-PE (1 min/50Hz)
Allowable Operation Temperature	-25 °C to 70 °C
IP-Protection	from front side IP 20 acc. to IEC 60529
Insulation cover	Suitable for appliances with protection class II acc. to IEC 61140
Panel Thickness S	Snap-in version 1.5/2/2.5/3 mm
Material: Housing	PA6, black / grey / white, UL 94V-0

appliance inlet/-outlet	C8 acc. to IEC 60320-1 UL 60320-1, CSA C22.2 no. 60320-1 (for cold conditions) pin-temperature 70 °C, 2.5A, Protection Class II
-------------------------	---

Approvals and Compliances

Detailed information on product approvals, code requirements, usage instructions and detailed test conditions can be looked up in [Details about Approvals](#)

Approvals



The approval mark is used by the testing authorities to certify compliance with the safety requirements placed on electronic products.

Approval Reference Type: 2578

Approval Logo	Certificates	Certification Body	Description
	VDE Approvals	VDE	VDE Certificate Number: 40002274
	UL Approvals	UL	UL File Number: E96454

Product standards

Product standards that are referenced

Organization	Design	Standard	Description
	Designed according to	IEC 60320-1	Appliance couplers for household and similar general purposes
	Designed according to	UL 60320-1	Standard for Attachment Plugs and Receptacles
	Designed according to	CSA C22.2 no. 60320-1	General Use Receptacles, Attachment Plugs, and Similar Wiring Devices





Application standards

Application standards where the product can be used

Organization	Design	Standard	Description
	Designed for applications acc.	IEC/UL 60950	IEC 60950-1 includes the basic requirements for the safety of information technology equipment.

Compliances

The product complies with following Guide Lines

Identification	Details	Initiator	Description
	CE declaration of conformity	SCHURTER AG	The CE marking declares that the product complies with the applicable requirements laid down in the harmonisation of Community legislation on its affixing in accordance with EU Regulation 765/2008.
	RoHS	SCHURTER AG	EU Directive RoHS 2011/65/EU
	China RoHS	SCHURTER AG	The law SJ / T 11363-2006 (China RoHS) has been in force since 1 March 2007. It is similar to the EU directive RoHS.
	REACH	SCHURTER AG	On 1 June 2007, Regulation (EC) No 1907/2006 on the Registration, Evaluation, Authorization and Restriction of Chemicals 1 (abbreviated as "REACH") entered into force.

Dimensions [mm]

PCB terminal with additional solder terminal in orientation A (horizontal)

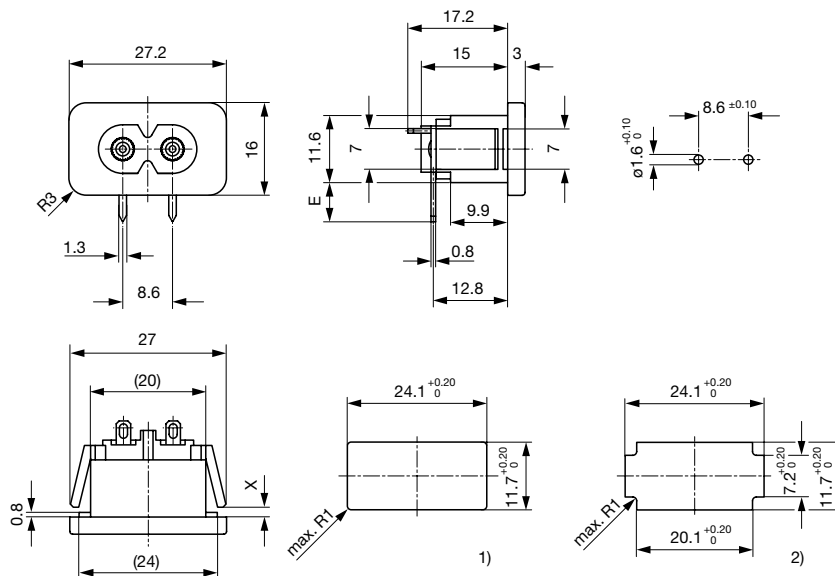

E = PCB terminal standard (additional solder): 6.8 mm

E = PCB terminal short (additional solder): 0.7 mm

E = PCB terminal long (additional solder): 15.8 mm

E = PCB terminal standard: 6.5 mm

E = PCB terminal short: 5.0 mm

E = PCB terminal long: 7.6 mm

1) Panel cut-out for panel thickness 1.5 / 2.0 / 2.5 / 3.0 mm

2) Panel cut-out for panel thickness 1.0 mm

Quick connect or solder terminal in orientation A (horizontal)

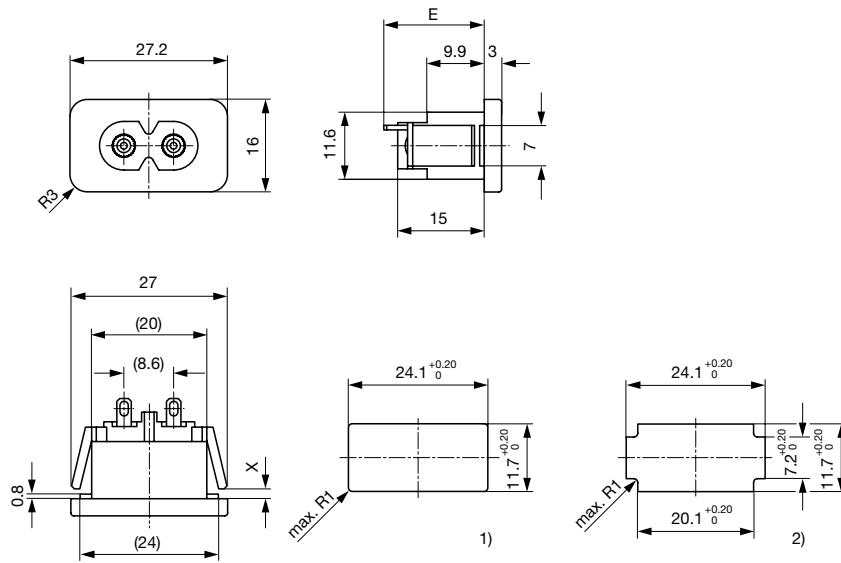

- E = Solder terminal short: 17.3 mm
- E = Solder terminal long: 21.0 mm
- E = Quick-connect terminal 2.8x0.8 mm: 23.3 mm

- 1) Panel cut-out for panel thickness 1.5 / 2.0 / 2.5 / 3.0 mm
- 2) Panel cut-out for panel thickness 1.0 mm

Quick connect or solder terminal in orientation B (vertical)

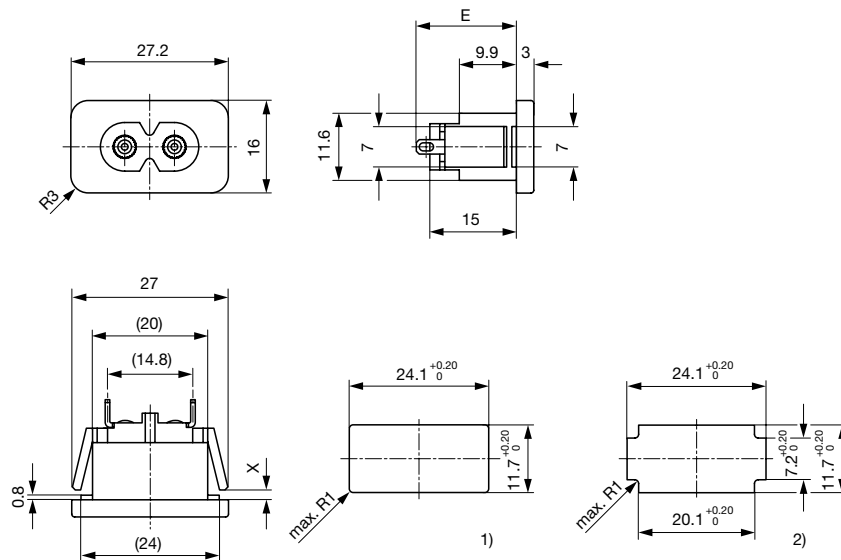

- E = Solder terminal short: 17.3 mm
- E = Solder terminal long: 21.0 mm
- E = Quick-connect terminal 2.8x0.8 mm: 23.3 mm
- E = Quick-connect terminal 4.8x0.8 mm: 21.8 mm
- E = Quick-connect terminal 6.3x0.8 mm: 22.8 mm

- 1) Panel cut-out for panel thickness 1.5 / 2.0 / 2.5 / 3.0 mm
- 2) Panel cut-out for panel thickness 1.0 mm

Config. Code











2578 - H - A B C 0 - D - E G F

The characters are placeholders for the correspondingly keys of selections from the key tables.

2578 - H - A B C 0 - D - E G F = Type

Type	Configuration key
protection class II	X

2578 - H - A B C 0 - D - E G F = Terminals

Terminal L	Configuration key
short solder terminal (L = 4.8 mm) 	2
long solder terminal (L = 8.5 mm) 	3
PCB-terminal standard (additional solder terminal) 	4
PCB-terminal short (additional solder terminal) 	5
PCB-terminal long (additional solder terminal) 	6
Blade terminal (2.8 x 0.8 mm) 	7
Blade terminal (4.8 x 0.8 mm) 	8
Blade terminal (6.3 x 0.8 mm) 	9
PCB-terminal (standard) 	A
PCB-terminal (short) 	B
PCB-terminal (long) 	C

2578 - H - A B C 0 - D - E G F = Terminals

Terminal N	Configuration key
short solder terminal (L = 4.8 mm)	2
long solder terminal (L = 8.5 mm)	3
PCB-terminal standard (additional solder terminal)	4
PCB-terminal short (additional solder terminal)	5

Symbols similar as in table A

Terminal N	Configuration key
PCB-terminal long (additional solder terminal)	6
Blade terminal (2.8 x 0.8 mm)	7
Blade terminal (4.8 x 0.8 mm)	8
Blade terminal (6.3 x 0.8 mm)	9
PCB-terminal (standard)	A
PCB-terminal (short)	B
PCB-terminal (long)	C

Symbols similar as in table A

2578 - H - A B C 0 - D - E G F = Terminals

Terminal Ground	Configuration key
without terminal	0

Symbols similar as in table A

2578 - H - A B C 0 - D - E G F = Color

Color	Configuration key
Black	A
Grey	B
White	D

2578 - H - A B C 0 - D - E G F = Style

Style	Configuration key
snap-in (s=panel thickness)	4

2578 - H - A B C 0 - D - E G F = Dimension S

Dimension "S"	Configuration key
15	
20	
25	
30	

The dimension "S" is displayed in ($\frac{1}{10}$ mm). This information is also valid for the order code

2578 - H - A B C 0 - D - E G F = Orientation of Terminals

Orientation of Terminals	Configuration key
horizontal	A
vertical	B

All Variants

Terminals L / N	Orientation of Terminals	Color	Panel Thickness s [1/10 mm]	Config. Code	Order Number
Blade terminal (2.8 x 0.8 mm)	vertical	Black	25	2578-X-7700-A-425B	6160.0027
short solder terminal (L = 4.8 mm)	vertical	Black	15	2578-X-2200-A-415B	6160.0029
long solder terminal (L = 8.5 mm)	vertical	Black	20	2578-X-3300-A-420B	6160.0031
Blade terminal (6.3 x 0.8 mm)	vertical	Black	15	2578-X-9900-A-415B	6160.0032
short solder terminal (L = 4.8 mm)	vertical	Black	25	2578-X-2200-A-425B	6160.0036
Blade terminal (6.3 x 0.8 mm)	vertical	Black	20	2578-X-9900-A-420B	6160.0069
short solder terminal (L = 4.8 mm)	vertical	Black	20	2578-X-2200-A-420B	6160.0071
Blade terminal (6.3 x 0.8 mm)	vertical	Black	25	2578-X-9900-A-425B	6160.0074
Blade terminal (2.8 x 0.8 mm)	vertical	Black	15	2578-X-7700-A-415B	6163.0016
short solder terminal (L = 4.8 mm)	vertical	Grey	25	2578-X-2200-B-425B	6163.0017

The listed variants should be available from stock. Other versions on request www.schurter.com/contact

Availability for all products can be searched real-time: <https://www.schurter.com/en/Stock-Check/Stock-Check-SCHURTER>

Packaging unit 100 Pcs

Accessories

Description



Retainer
 Retainer for power supply cord

Mating Outlets/Connectors

Category / Description

[Power Cord Overview complete](#)



Cord Sets 2.5 A, IEC Connector, Black, 2.0 m, H03VVH2-F 2x0,75mm², Connector IEC C7, 001500 mm, H03VVH2-F2G0.75, black 6013.0474

Cord Sets 2.5 A, IEC Connector, Black, 4.0 m, H03VVH2-F 2x0,75mm², Connector IEC C7, 001500 mm, H05VVH2-F2G0.75, black 6013.0478

[Power Cord further types to 2578](#)

[Power Supply Cord Overview complete](#)



Cord Sets 2.5 A, North America, Black, 2.0 m, SVT 2x18AWG, Connector IEC C7, 002500 mm, NISPT-2, black 6010.5274

Cord Sets 2.5 A, North America, Black, 4.0 m, SVT 2x18AWG, Connector IEC C7, 002500 mm, NISPT-2, black 6010.5278

[Power Supply Cord further types to 2578](#)