

深圳市昱申科技有限公司

CHINA YOUNG SUN LED TECHNOLOGY CO., LTD.

TEL: (86) 755-28079401 28079402 28079403 28079404 28079405

FAX: (86) 755-28079407 E-mail: info@100LED.com Web: www.100LED.com

Model No.: YSD-439AB4B-35

Applications:

-  Moving Message Display
-  Full Color Display
-  Banking Board
-  Score Boards
-  Digital Display

LED Chip Absolute Maximum Ratings: (Ta=25 °C)

Parameter	Symbol	Red	Unit
Forward current	I _F	20	mA
Peak forward current (Duty Cycle=1/10, 10KHz)	I _{PF}	30	mA
Reverse voltage (V _R =5V)	I _R	10	μ A
Operating temp	T _{OPR}	-25 - 85	°C
Storage temp	T _{STG}	-30 - 85	°C
Peak Emission Wavelength	λ _{PH}	463	nm

* Soldering Bath: not more than 5 seconds @260 °C. The bottom ends of the plastic reflector should be at least 2mm above the solder surface

Soldering Iron: not more than 3 seconds @300 °C under 30W

LED Chip Typical Electrical & Optical Characteristics: (Ta=25 °C)

ITEMS	Symbol	Condition	Min.	Typ.	Max.	Unit
Forward Voltage	V _F	I _F =20mA	3.2	3.4	3.5	V
Luminous Intensity	I _v	I _F =20mA	150	200	250	mcd
Wavelength	Δ λ	I _F =20mA	460	463	465	nm
Light Degradation after 1000 hours			-4.68% ~ -8.27%			

Address: 5/F, Building B, Anzhilong Indl., Qinghua East Road., Longhua Town, Shenzhen CHINA. 518109

www.100LED.com

ONE HUNDRED LED
PERFECT LED

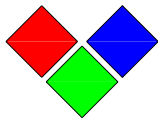

深圳市昱申科技有限公司

CHINA YOUNG SUN LED TECHNOLOGY CO., LTD.

TEL: (86) 755-28079401 28079402 28079403 28079404 28079405

FAX: (86) 755-28079407 E-mail: info@100LED.com Web: www.100LED.com

Mechanical Dimensions:

- . All dimension are in mm, tolerance is $\pm 0.2\text{mm}$ unless otherwise noted
- . An epoxy meniscus may extend about 1.5mm down the leads.

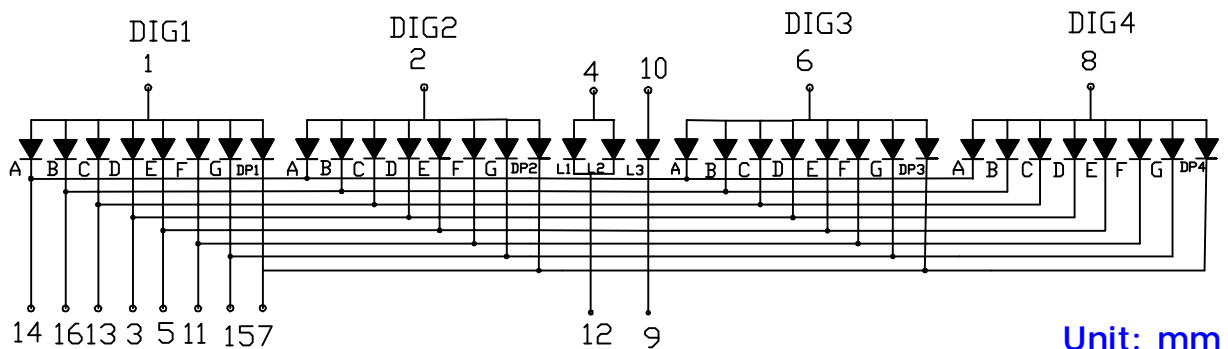
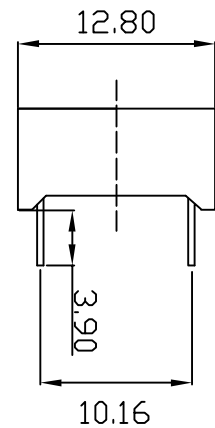
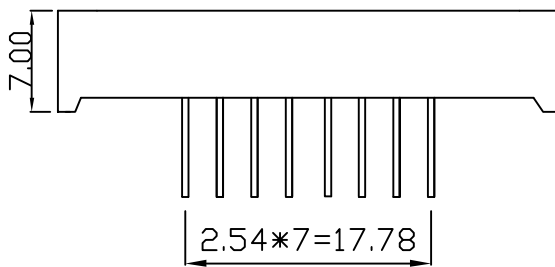
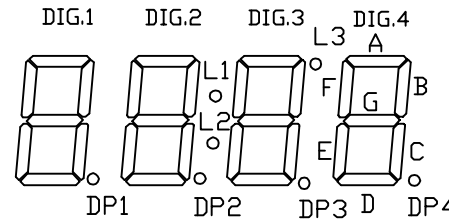
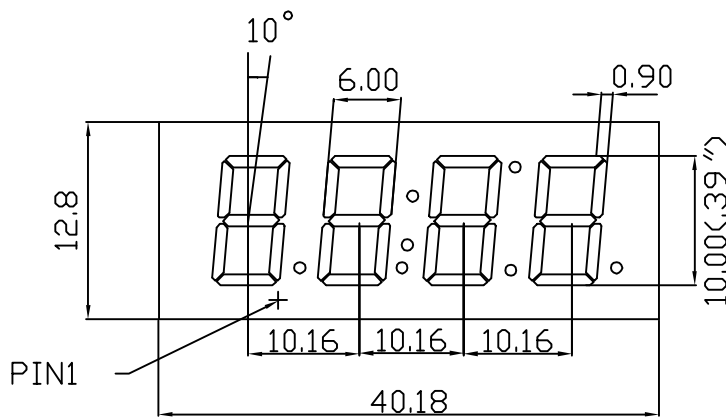

Unit: mm