

SJ100433
(DRAWING NO.)

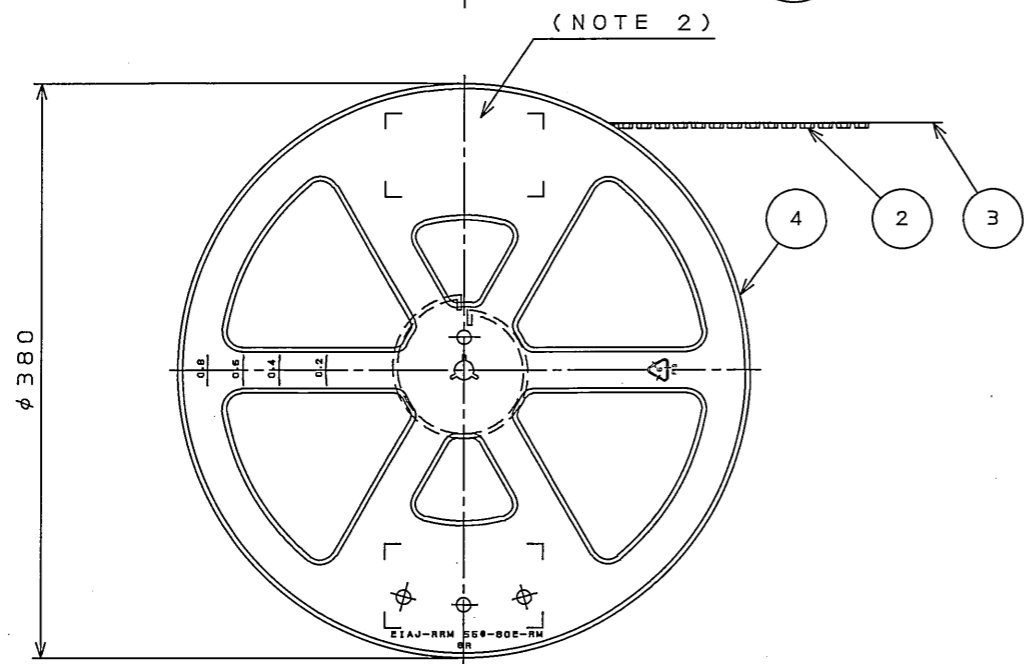
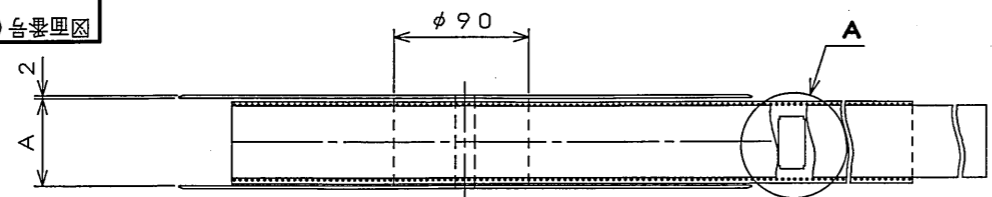

版数 REV.	年月日 DATE	DCN NO.	変更内容 DESCRIPTION	製図 DR.	担当 CHK.	査閲 APPD.	承認 APPD.
2	10.Mar.2004	054574	ADDED ITEMS		T.SHIODA	K.Kawase	S.Kashiwagi

TABLE 1

PART NO.	A	B	C	D	E	F	MATERIAL OF CARRIER TAPE
WR- 22P-HF-HD-A1E-R1200	26	24	11.5	—	11.8	0.4	PP.
WR- 30P-HF-HD-A1E-R1200	26	24	11.5	—	13.8	0.4	PP.
WR- 40P-HF-HD-A1E-R1200	26	24	11.5	—	16.3	0.5	PP.
WR- 50P-HF-HD-A1E-R1200	34	32	14.2	28.4	18.8	0.4	PP.
WR- 60P-HF-HD-A1E-R1200	34	32	14.2	28.4	21.3	0.5	PP.
WR- 70P-HF-HD-A1E-R1200	46	44	20.2	40.4	23.8	0.4	PP.
WR- 80P-HF-HD-A1E-R1200	46	44	20.2	40.4	26.3	0.5	PS.
WR-120P-HF-HD-A1E-R1200	58	56	26.2	52.4	36.3	0.4	PS.

- NOTE1. SUFFIX "-R1200" OF THE PART NUMBER INDICATES THAT 1200 PCS. OF WR-*P-HF-HD-A1E ARE ACCOMMODATED IN REEL.
2. THE LEVEL, IN WHICH PART NO., NO. OF CONNECTORS, LOT NO., TAPE WIDTH AND FEED PITCH ARE MARKED IS TO BE ATTACHED ON THE MAGAZINE AS SHOWN.
3. REFER TO THE DRAWING, SJ100432 (WR-*P-HF-HD-A1E) FOR THE DIMENSIONS OF THE CONNECTOR.
4. IN CASE THAT DIMENSIONS B (TAPE WIDTH) IS 16, 24mm THERE IS PILOT HOLES AT THE ONE SIDE ONLY.

- "WR-*P-HF-HD-A1E-R1200"は 収納数1200個入りのリールに収納された品名を表す。
- 図示の位置に 右記のシールを貼り、品名、収納数、ロットNo. 及び テープの幅と送りピッチを記入する。
- コネクタ寸法は SJ100432 (WR-*P-HF-HD-A1E)参照。
- B寸法(テープ幅)が16及び24の場合、パイロット穴は片側のみである。

JAE 日本航空電子工業株式会社
MADE IN JAPAN

品名	WR-*P-HF-HD-A1E-R1200	
収納数	1200 個入	製造年月日 [Lot No.]
備考	TB**12	

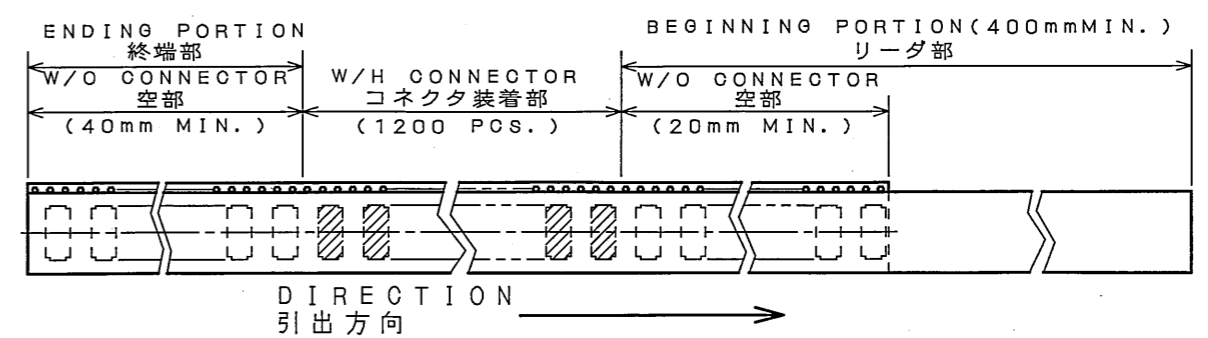
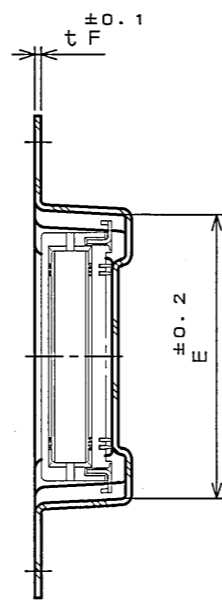
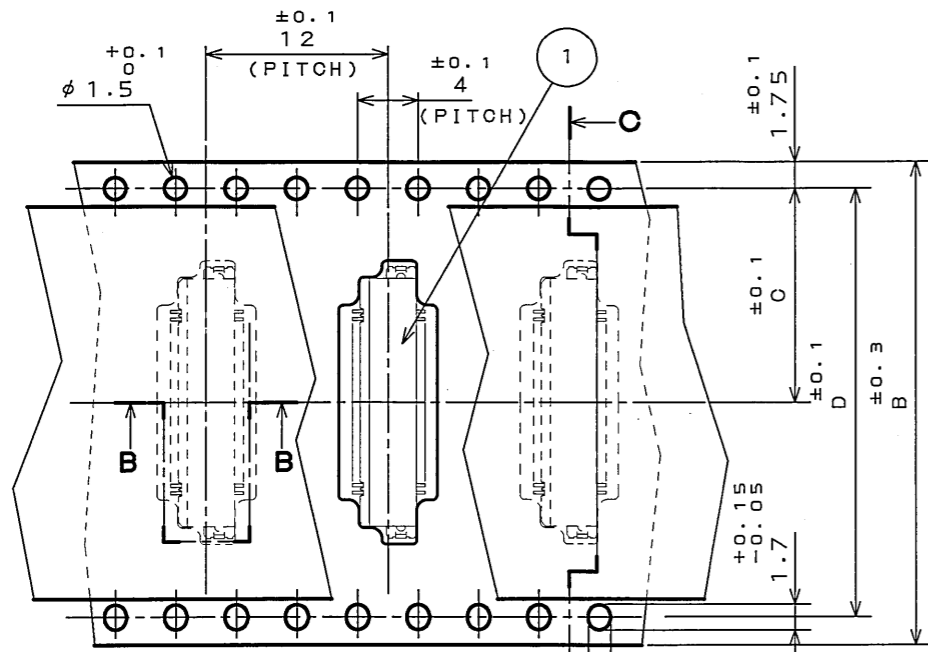

DETAIL A
(SCALE 2:1)

SECT. C-C
(SCALE 2:1)

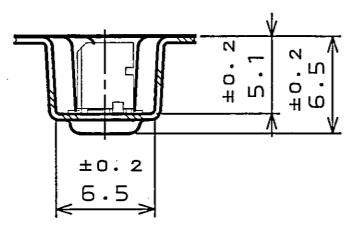

SECT. B-B
(SCALE 2:1)

符号 NO.	名称 DESCRIPTION	個数 QTY.	材料 MATERIAL	仕上 FINISH	備考 REMARKS
4	PLASTIC REEL	—	PS (RECYCLE)		
3	COVER TAPE	—	PET.		
2	CARRIER TAPE	—	TABLE 1		
1	CONNECTOR	1200			NOTE3

仕様書 (SPECIFICATION) 第1版 (ORIGINAL DATE) 4.Dec.2003

製図 DR. S.MIURA 名称 (TITLE) WR-*P-HF-HD-A1E-R1200

担当 CHK. T.SHIODA

査閲 APPD. K.KAWASE

承認 APPD. S.KASHIWAGI

重量 (WEIGHT)

JAE CONNECTOR DIV. PROPRIETARY. COPYRIGHT (C) 2003. JAPAN AVIATION ELECTRONICS INDUSTRY, LTD.

図面番号 (DRAWING NO.) SJ100433

版数 (REV.) 2

DOF-0-212E(03.08)

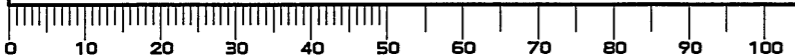

LEAD FREE この製品は鉛フリー品です